

SP1005 Series 30pF 30kV Bidirectional Discrete TVS

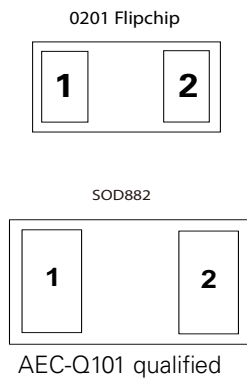

**Pinout**



**Functional Block Diagram**

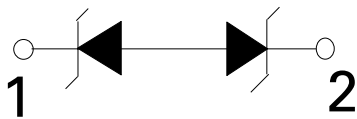

**Additional Information**



Datasheet



Resources



Samples

**Description**

The SP1005 includes back-to-back Zener diodes fabricated in a proprietary silicon avalanche technology to provide protection for electronic equipment that may experience destructive electrostatic discharges (ESD). These robust diodes can safely absorb repetitive ESD strikes above the maximum level specified in the IEC 61000-4-2 international standard (Level 4, ±8kV contact discharge) without performance degradation. The back-to-back configuration provides symmetrical ESD protection for data lines when AC signals are present.

**Features**

- ESD, IEC 61000-4-2, ±30kV contact, ±30kV air
- EFT, IEC 61000-4-4, 40A (5/50ns)
- Lightning, IEC 61000-4-5 (2nd Ed.), 10A ( $t_p=8/20\mu s$ )
- Low capacitance of 30pF (@  $V_R=0V$ )
- Low leakage current of 0.1µA at 5V
- Space efficient 0201 and 0402 footprint
- AEC-Q101 qualified (SOD882 package)

**Applications**

- Mobile Phones
- Smart Phones
- Camcorders
- Portable Medical
- Digital Cameras
- MP3/PMP
- Portable Navigation Devices
- Tablets
- Point of Sale Terminals

**Application Example**

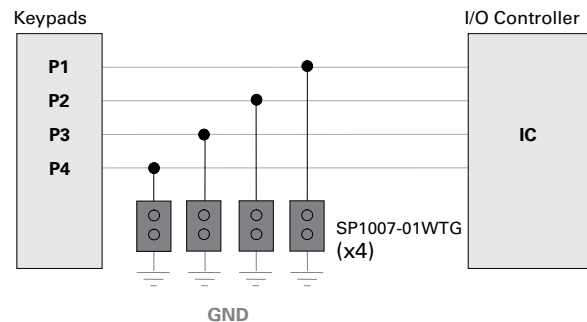

Life Support Note:

**Not Intended for Use in Life Support or Life Saving Applications**

The products shown herein are not designed for use in life sustaining or life saving applications unless otherwise expressly indicated.

### Absolute Maximum Ratings

Symbol	Parameter	Value	Units
$I_{PP}$	Peak Current ( $t_p=8/20\mu s$ )	10.0 <sup>1</sup>	A
		8.0 <sup>2</sup>	
$T_{OP}$	Operating Temperature	-40 to 125	°C
$T_{STOR}$	Storage Temperature	-55 to 150	°C

Notes:

- "1" indicates SP1005-01WTG, while "2" indicates SP1005-01ETG
- CAUTION: Stresses above those listed in "Absolute Maximum Ratings" may cause permanent damage to the device. This is a stress only rating and operation of the device at these or any other conditions above those indicated in the operational sections of this specification is not implied.

### Thermal Information

Parameter	Rating	Units
Storage Temperature Range	-55 to 150	°C
Maximum Junction Temperature	150	°C
Maximum Lead Temperature (Soldering 20-40s)	260	°C

### Electrical Characteristics ( $T_{OP}=25^\circ C$ )

Parameter	Symbol	Test Conditions	Min	Typ	Max	Units
Reverse Standoff Voltage	$V_{RWM}$				6.0	V
Breakdown Voltage	$V_{BR}$	$I_R=1mA$		8.5	9.5	V
Leakage Current	$I_{LEAK}$	$V_R=5V$ with 1 pin at GND		0.1	0.5	$\mu A$
Clamp Voltage <sup>1</sup>	$V_C$	$I_{pp}=1A, t_p=8/20\mu s, Fwd$		9.3		V
		$I_{pp}=2A, t_p=8/20\mu s, Fwd$		10.0		V
		$I_{pp}=10A, t_p=8/20\mu s, Fwd$		15.6		V
Dynamic Resistance <sup>2</sup>	$R_{DYN}$	TLP, $t_p=100ns, I/O$ to GND		0.28		$\Omega$
ESD Withstand Voltage <sup>1</sup>	$V_{ESD}$	IEC61000-4-2 (Contact Discharge)	$\pm 30$			kV
		IEC61000-4-2 (Air Discharge)	$\pm 30$			kV
Diode Capacitance <sup>1</sup>	$C_D$	Reverse Bias=0V		30		pF
		Reverse Bias=2.5V		23		pF

Notes:

- Parameter is guaranteed by design and/or device characterization.
- Transmission Line Pulse (TLP) with 100ns width and 200ns rise time.

### Capacitance vs. Reverse Bias

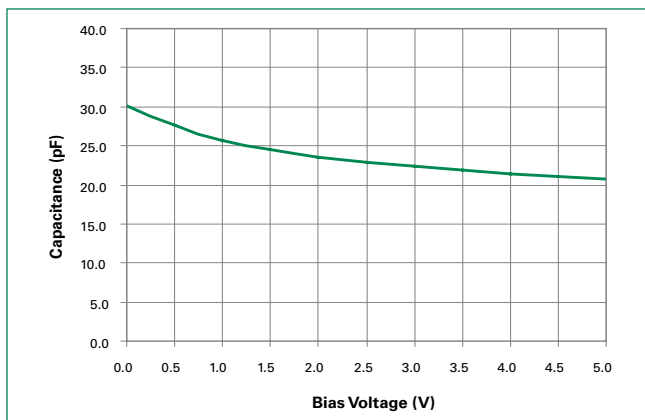

### Pulse Waveform

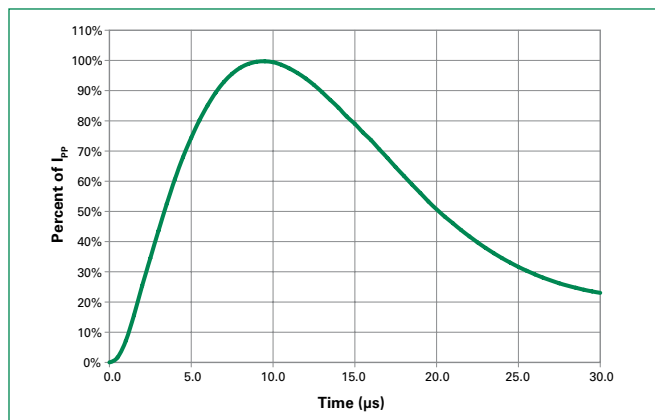

**Clamping Voltage vs.  $I_{pp}$**

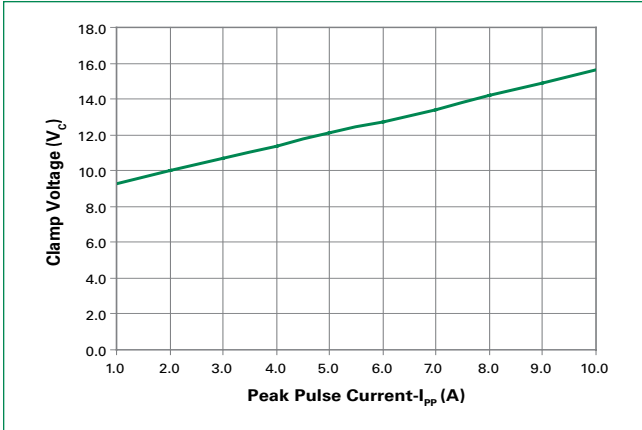

**Insertion Loss (S21) I/O to GND**

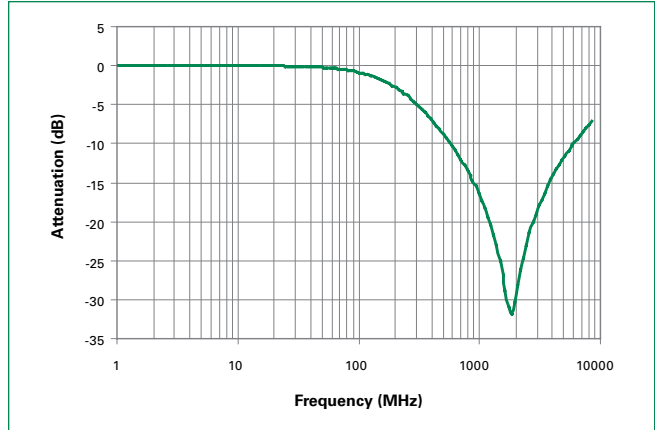

**Transmission Line Pulsing (TLP) Plot**

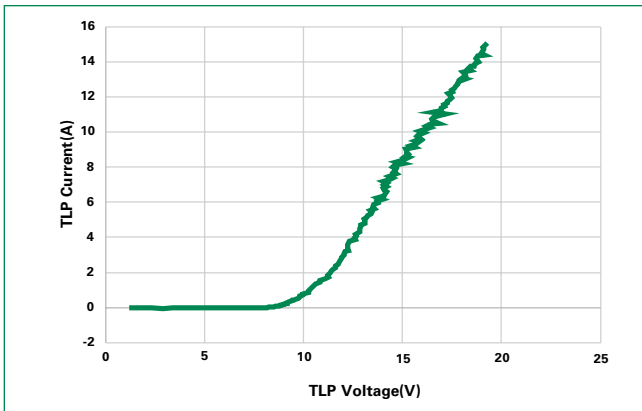

**Product Characteristics of SOD-882 Package**

<b>Lead Plating</b>	Pre-Plated Frame
<b>Lead Material</b>	Copper Alloy
<b>Lead Coplanarity</b>	0.0004 inches (0.102mm)
<b>Substitute Material</b>	Silicon
<b>Body Material</b>	Molded Epoxy
<b>Flammability</b>	UL 94 V-0

- Notes :
1. All dimensions are in millimeters
  2. Dimensions include solder plating.
  3. Dimensions are exclusive of mold flash & metal burr.
  4. Blo is facing up for mold and facing down for trim/form, i.e. reverse trim/form.
  5. Package surface matte finish VDI 11-13.

**Soldering Parameters**

<b>Reflow Condition</b>	Pb – Free assembly	
<b>Pre Heat</b>	- Temperature Min ( $T_{s(min)}$ )	150°C
	- Temperature Max ( $T_{s(max)}$ )	200°C
	- Time (min to max) ( $t_s$ )	60 – 180 secs
<b>Average ramp up rate (Liquidus) Temp (<math>T_L</math>) to peak</b>	3°C/second max	
<b><math>T_{s(max)}</math> to <math>T_L</math> - Ramp-up Rate</b>	3°C/second max	
<b>Reflow</b>	- Temperature ( $T_L$ ) (Liquidus)	217°C
	- Temperature ( $t_L$ )	60 – 150 seconds
<b>Peak Temperature (<math>T_p</math>)</b>	260 <sup>+0.5</sup> °C	
<b>Time within 5°C of actual peak Temperature (<math>t_p</math>)</b>	20 – 40 seconds	
<b>Ramp-down Rate</b>	6°C/second max	
<b>Time 25°C to peak Temperature (<math>T_p</math>)</b>	8 minutes Max.	
<b>Do not exceed</b>	260°C	

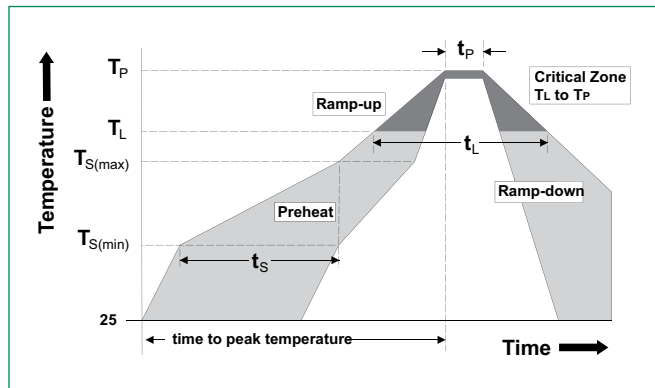

**Part Marking System**

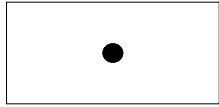

SP1005-01WTG

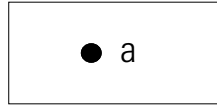

SP1005-01ETG

**Part Numbering System**

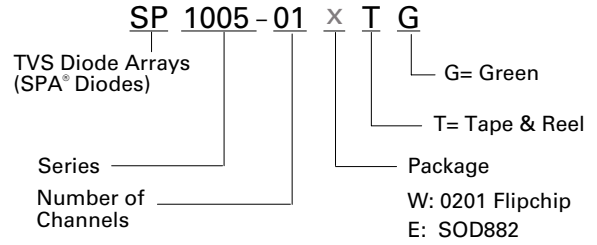

**Ordering Information**

Part Number	Package	Marking	Min. Order Qty.
SP1005-01WTG	0201 Flipchip	•	10,000
SP1005-01ETG	SOD882	•a	10,000

**Package Dimensions — 0201 Flipchip**

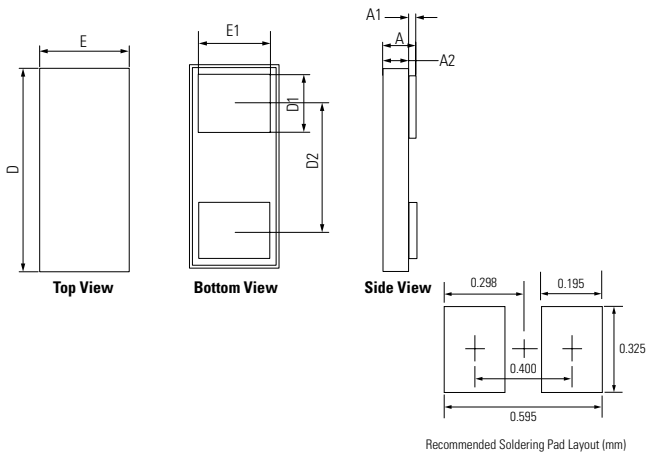

Symbol	0201 Flipchip			
	Millimeters		Inches	
	Min	Max	Min	Max
<b>D</b>	0.605	0.655	0.0238	0.0258
<b>E</b>	0.305	0.345	0.0120	0.0140
<b>D1</b>	0.145	0.155	0.0057	0.0061
<b>E1</b>	0.245	0.255	0.0096	0.0100
<b>D2</b>	0.400 BSC		0.0157 BSC	
<b>A</b>	0.273	0.329	0.0107	0.0130
<b>A2</b>	0.265	0.315	0.0104	0.0124
<b>A1</b>	0.008	0.014	0.0003	0.0006

**Package Dimensions — SOD882**

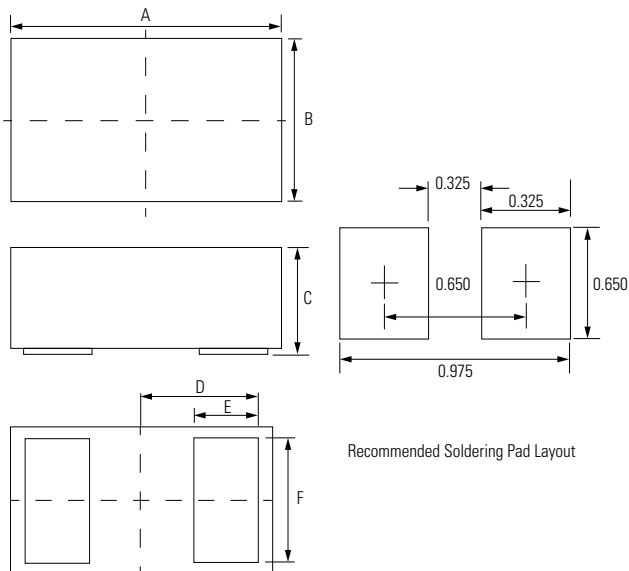

Symbol	Package	SOD882					
	JEDEC	MO-236					
		Millimeters			Inches		
		Min	Typ	Max	Min	Typ	Max
<b>A</b>		0.90	1.00	1.10	0.035	0.039	0.043
<b>B</b>		0.50	0.60	0.70	0.020	0.024	0.028
<b>C</b>		0.40	0.50	0.60	0.016	0.020	0.024
<b>D</b>		0.45			0.018		
<b>E</b>		0.20	0.25	0.35	0.008	0.010	0.012
<b>F</b>		0.45	0.50	0.55	0.018	0.020	0.022

**Embossed Carrier Tape & Reel Specification – 0201 Flipchip**

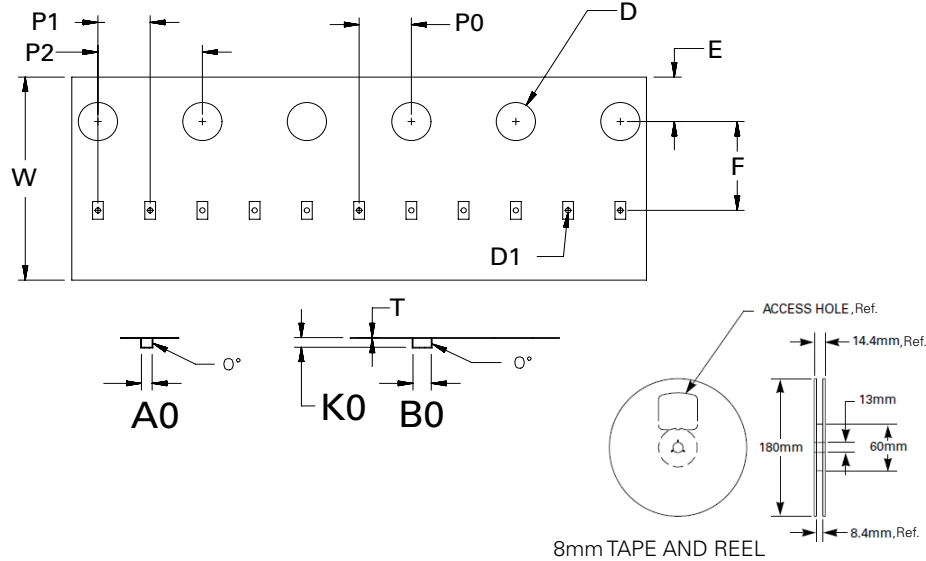

Symbol	Millimeters
A0	0.41+/-0.03
B0	0.70+/-0.03
D	ø 1.50 + 0.10
D1	ø 0.20 +/- 0.05
E	1.75+/-0.10
F	3.50+/-0.05
K0	0.38+/-0.03
P0	2.00+/-0.05
P1	2.00+/-0.05
P2	4.00+/-0.10
W	8.00 + 0.30 -0.10
T	0.23+/-0.02

**Embossed Carrier Tape & Reel Specification – SOD882**

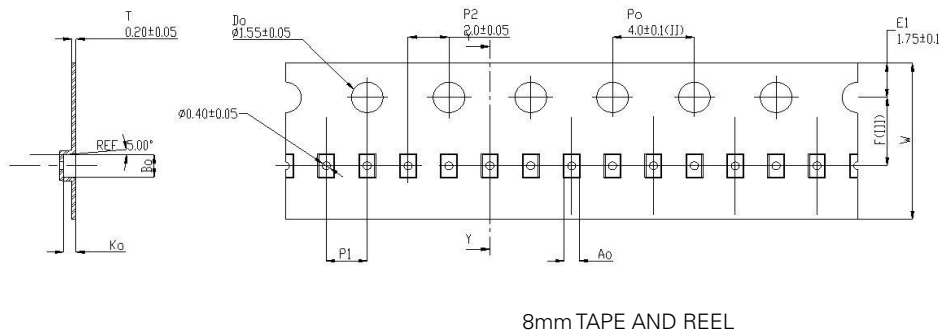

Symbol	Millimeters
A0	0.70+/-0.045
B0	1.10+/-0.045
K0	0.65+/-0.045
F	3.50+/-0.05
P1	2.00+/-0.10
W	8.00 + 0.30 -0.10

**Disclaimer Notice** - Information furnished is believed to be accurate and reliable. However, users should independently evaluate the suitability of and test each product selected for their own applications. Littelfuse products are not designed for, and may not be used in, all applications. Read complete Disclaimer Notice at <http://www.littelfuse.com/disclaimer-electronics>.