

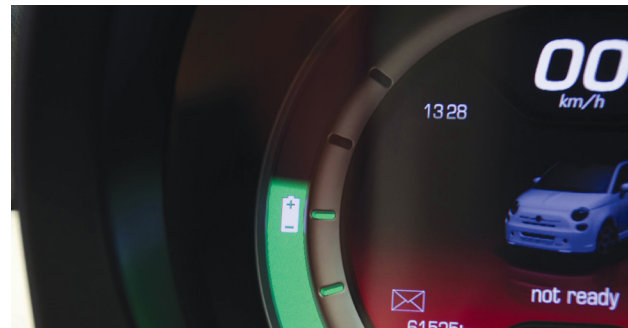

Expertise Applied | Answers Delivered



## AUTOMOTIVE PASSENGER CAR CATALOG

**BLADE FUSES**  
**HIGH VOLTAGE FUSES**  
**SMD COMPONENTS**

**CARTRIDGE FUSES**  
**MASTERFUSES**  
**CABLE PROTECTION**

**HIGH CURRENT FUSES**  
**PAL FUSES**  
**SPECIALTY PRODUCTS**

# Our offering encompasses a wide range of applications



<b>Powertrain</b>	Engine Management Transmission Control Cooling Fan Water Pump
<b>Safety</b>	ABS EPAS Air Bag Chassis Control
<b>Comfort</b>	Window Lift Sun Roof Door Lock Power Seat HVAC
<b>Infotainment</b>	Dashboard Navigation In-Car Entertainment
<b>Fuse Box Power Supply Lighting</b>	Wire Harness Generator HID Headlight Headlight Leveling Directional Lighting

# Helping to make the World a Cleaner Place to Live



## Littelfuse and the Environment

As members of the global community, we at Littelfuse have always strived to understand the impact of what we do, and of what we create, on the world around us. Because of this, our concern for the environment has always been an integral and fundamental part of our business. We continually work to balance our business objectives with the need to protect and improve the local and global environment.

## Our Strategy for the Design of Eco-friendly Products

Littelfuse has established a focused program committed to developing high-performance eco-friendly products along with a comprehensive set of processing/reliability data and technical process expertise. This includes processes for eliminating, detecting and documenting the presence of hazardous materials such as

- Lead
- Cadmium
- Hexavalent Chromium
- Mercury
- Brominated flame-retardants (PBBs and PBDEs)

The Littelfuse strategy for eco-friendly products is specifically designed to help support our worldwide customers in their transition to Lead-Free processing.



All products considered to be lead-free are marked with this symbol.

Littelfuse defines lead-free as products which contain less than 1000ppm (0.1%) Lead, measured by weight of the entire product.



All RoHS compliant products are marked with this symbol.

Littelfuse follows the requirement set by the European Union for all RoHS compliant products. The European Union Directive 2002/95/EC RoHS restricts the use of Lead, Mercury, Hexavalent Chromium, Cadmium and Brominated flame-retardants (PBBs and PBDEs)

Visit [www.littelfuse.com/lead-free](http://www.littelfuse.com/lead-free) for further information.

# Portfolio of Littelfuse automotive technologies, products & services

Passenger Automobiles | Aftermarket

## SERVICES

Product Technologies Plus Application Design Evaluation Services  
Littelfuse is the world leader in circuit protection. We offer an extensive selection of circuit protection technologies for Automotive applications. Littelfuse circuit protection expert staff can assist you in designing circuit protection for your most demanding applications. Solutions for over-current applications as well as over-voltage applications are available from Littelfuse.



## CIRCUIT PROTECTION TECHNOLOGIES (1-9)

### 1. Fuses/Footprint Reduction

MICRO2™, MICRO3™ fuses



### 2. Medium Current Cartridge Fuses

MCASE+™ cartridge fuses; considerably smaller than JCASE® and Low Profile JCASE® fuses

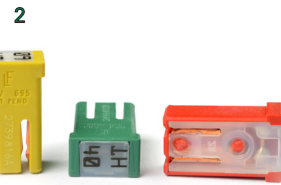

### 3. Discrete High Current Fuses

High Current Bolt Down fuses and fuse arrays

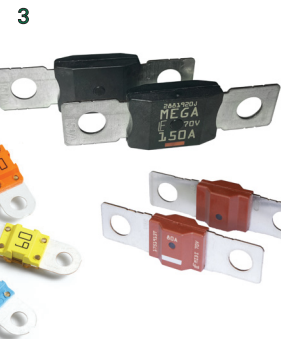

### 4. ZCase Masterfuse

Smallest high current distribution product in the industry

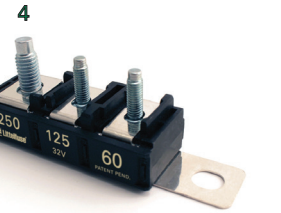

### 5. Masterfuse

High current distribution array



### 6. ZCase Single MEGA

Minimal Footprint Bolt Down fuse



### 7. High Voltage Fuses

Low-current fuses for Electric and Hybrid Electric Vehicles



### 8. Battery Cable Protection

CABLE PRO® protectors for mounting directly inline as part of a high power cable assembly



### 9. SMD Autofuse

SMD fuses for printed circuit boards



Littelfuse® products are not designed for, and shall not be used for, any purpose (including, without limitation, automotive, military, aerospace, medical, life-saving, life-sustaining or nuclear facility applications, devices intended for surgical implant into the body, or any other application in which the failure or lack of desired operation of the product may result in personal injury, death, or property damage) other than those expressly set forth in applicable Littelfuse® product documentation. Warranties granted by Littelfuse® shall be deemed void for products used for any purpose not expressly set forth in applicable Littelfuse® documentation. Littelfuse® shall not be liable for any claims or damages arising out of products used in applications not expressly intended by Littelfuse® as set forth in applicable Littelfuse® documentation. The sale and use of Littelfuse® products is subject to Littelfuse Terms and Conditions of Sale, unless otherwise agreed by Littelfuse®.

# TABLE OF CONTENTS



BLADE FUSES	1
CARTRIDGE FUSES	22
HIGH CURRENT FUSES	30
SMD FUSES	71
CABLE & PAL FUSES	74
HIGH VOLTAGE FUSES	78
SPECIALTY PRODUCTS	87
FUSEOLOGY	90

## BLADE FUSES

---



MICRO2™ Blade Fuse 32V	2
MICRO3™ Blade Fuse 32V	4
Low Profile MINI® Fuses Rated 58V	6
Low Profile MINI® 10.9 Fuses Rated 58V	8
MINI® Blade Fuse Rated 32V	10
MINI® Blade Fuse Rated 58V	12
ATOF® Blade Fuse Rated 32V	14
MAXI® Blade Fuse Rated 32V	16
MAXI® Blade Fuse Rated 58V	18
MAXI+® Blade Fuse Rated 32V	20



MICRO2™ Blade Fuses

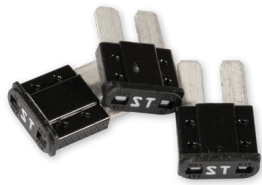

MICRO2™ Shunt

## MICRO2™ Blade Fuses Rated 32V

The MICRO2™ Fuse is the new standard for vehicle circuit protection. Its sub-miniature design meets the need for more circuits to be protected while utilizing less space and its ability to cope with high temperatures in adverse environments makes the MICRO2™ Fuse of recommended choice for protection. Black amperage stamps are used on the 20A & 25A / light colored housings to improve contrast for vision system inspection.

### Specifications

	MICRO2 (Silver Plated)	MICRO2 Sn (Tin Plated)
Voltage Rating:	32 VDC	32 VDC
Interrupting Ratings:	1000A @ 32 VDC	1000A @ 32 VDC
*Recommended Environmental Temperature:	-40°C to +125°C	-40°C to +125°C
Terminals Material:	Silver plated zinc alloy	Tin plated zinc alloy
Housing Material:	PA66 (U.L. 94 Flammability rating – V2)	PA66 (U.L. 94 Flammability rating – V2)
Net Weight Per Fuse:	0.53±5% gr	0.53±5% gr
Complies with:	SAE 2741, ISO 8820-12:2020	

\*Tin plating's temperature limit is ≈130°C. Silver plating allows up to 150°C at the terminal interface.

### RoHS

### Ordering Information

Part Number	Rating	Package Size	% of Rating	Opening Time Min / Max (s)
MICRO2 (Silver Plated)			110	360,000 / ∞
0327xxx.YX2S	3-30 & SHUNT	4000	135	0.75 / 120
			160	0.3 / 50
			200	0.15 / 5
0327xxx.UXS	3-30	500	350	0.04 / 0.5
0327xxx.LXS	3-30	50	600	0.02 / 0.1
MICRO2 (Tin Plated)				
0327xxx.YX2T	5-30	4000		

### Time-Current Characteristics

### Time-Current Characteristic Curves

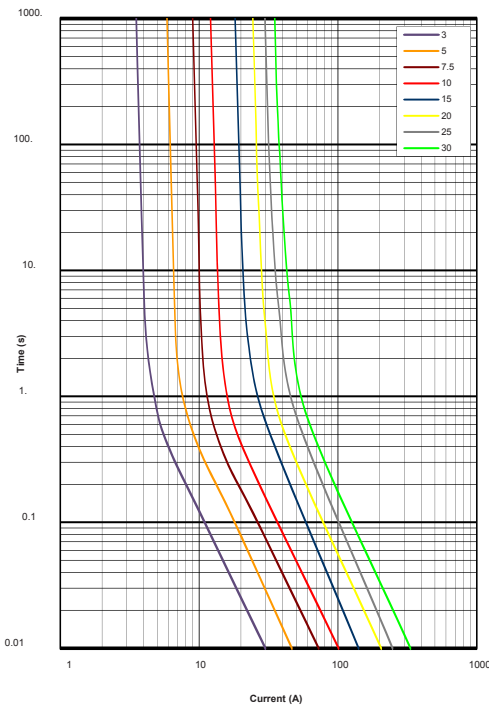

### Ratings

Part Number	Current Rating (A)	Housing Material Color	Test Cable Size (mm <sup>2</sup> )	Typ. Voltage Drop (mV)	Typ. Cold Resistance (mΩ)	Typ. I <sup>2</sup> t (A <sup>2</sup> s)
0327003_	3 (*)		0.35	113	31.7	9
0327005_	5		0.5	116	17.4	17
032707.5_	7.5		0.75	106	10.8	47
0327010_	10		1	102	7.7	90
0327015_	15		1.5	94	4.9	190
0327020_	20		2.5	91	3.5	400
0327025_	25		2.5	90	2.6	580
0327030_	30		4	88	2.1	1,000
0327900_	SHUNT		-	-	-	-

\* 3 A rating is available only as Silver Plated version

The typical I<sup>2</sup>t is an average value calculated from the breaking capacity tests by using the melting time before the arcing occurs.



## MICRO2™ Blade Fuses Rated 32V

### Dimensions

Dimensions in mm for reference only.  
See outline drawing for dimensions and tolerances.

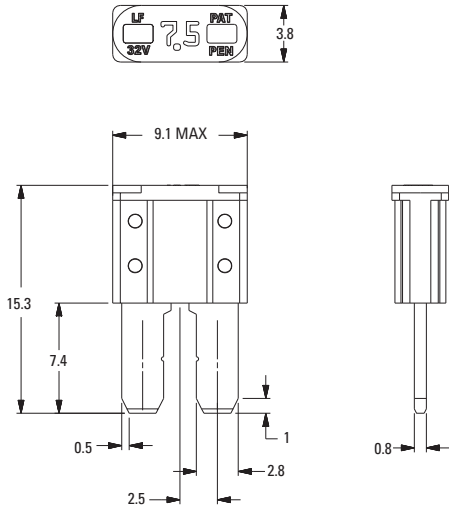

### Temperature Table

	max. allowed current load [A] at ambient temperature (typical derating)						
	-40°C	0°C	20°C	65°C	85°C	110°C	125°C
<b>3A</b>	3	3	3	3	2	2	2
<b>5A</b>	5	5	5	4	4	3	3
<b>7.5A</b>	7.5	7.5	7	6	5	5	4
<b>10A</b>	10	10	10	8	7	6	5
<b>15A</b>	15	15	14	12	10	9	8
<b>20A</b>	20	20	18	15	14	12	10
<b>25A</b>	25	23	22	18	17	14	12
<b>30A</b>	30	27	26	22	20	17	14

MICRO2 SHUNT Maximum Continuous Load: 20A.

### Typical Derating Of Fuse Melting Element

Temperature Security Margin is 20%  
Wire Cross Section And Fixture Test Set Up Refer To ISO 8820-12  
Please Contact Littelfuse® For Details Regarding Derating Test Set Up

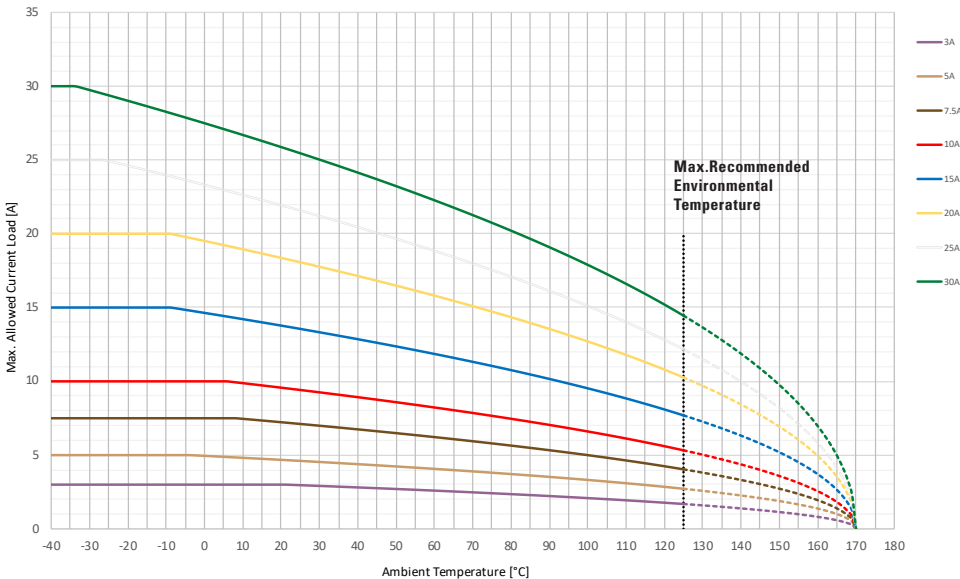

Derating curves may change depending on the final condition of the application (terminals characteristics, wire size exc.). Please ask Littelfuse® for more information.



MICRO3™ Blade Fuses



MICRO3™ Shunt

## MICRO3™ Blade Fuses Rated 32V

The MICRO3™ Fuse has 3 terminals and 2 fuse elements with a common center terminal. Its sub-miniature design meets the need for more circuits to be protected while utilizing less space and its ability to cope with high temperatures in adverse environments makes the MICRO3™ Fuse of recommended choice for protection.

### Specifications

Voltage Rating:	32 VDC
Interrupting Ratings:	1000A @ 32 VDC
*Recommended Environmental Temperature:	-40°C to +125°C
Terminals Material:	Silver plated zinc alloy
Housing Material:	PA66 (U.L. 94 Flammability rating – V2)
Net Weight Per Fuse:	0.95±10% gr
Complies with:	SAE 2741 and ISO 8820-3 in reference to electrical, mechanical and environmental performance requirements



\*Silver plating allows up to 150°C at the terminal interface.

### Ordering Information

Part Number	Rating	Package Size
0337xxx.PX2S	3 - 15 & SHUNT	2000
0337xxx.LXS	3 - 15	50

### Time-Current Characteristics

% of Rating	Opening Time Min / Max (s)
110	360,000 / ∞
135	0.75 / 120
160	0.3 / 50
200	0.15 / 5
350	0.04 / 0.5
600	0.02 / 0.1

### Time-Current Characteristic Curves

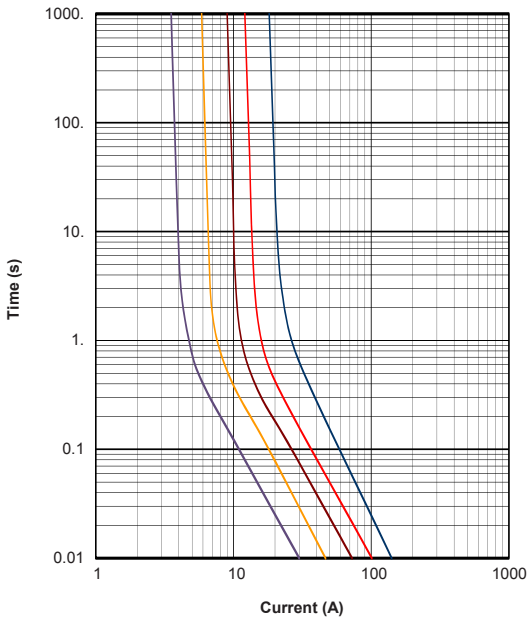

### Ratings

Part Number	Current Rating (A)	Housing Material Color	Test Cable Size (mm <sup>2</sup> )		Typ. Voltage Drop (mV)	Typ. Cold Resistance (mΩ)	Typ. I <sup>2</sup> t (A <sup>2</sup> s)
			Side Fuse Blades	Center Fuse Blades			
0337003_	3		0.5	1	113	31.7	9
0337005_	5		0.5	1	116	17.4	17
033707.5_	7.5		0.75	1.5	106	10.8	47
0337010_	10		1	2.5	102	7.8	89
0337015_	15		1.5	4	94	4.9	189
0337900_	SHUNT		-	-	-	-	-

The typical I<sup>2</sup>t is an average value calculated from the breaking capacity tests by using the melting time before the arcing occurs.

## MICRO3™ Blade Fuses Rated 32V

### Dimensions

Dimensions in mm for reference only.  
See outline drawing for dimensions and tolerances.

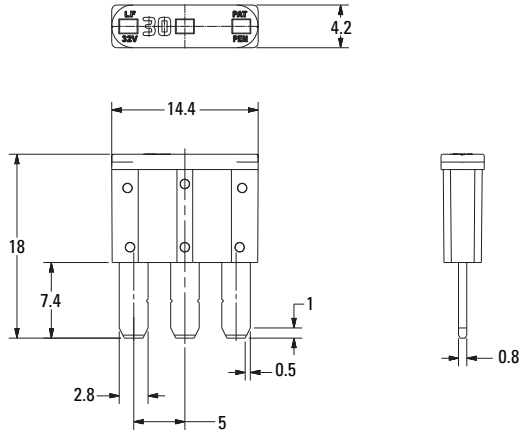

### Temperature Derating Curve

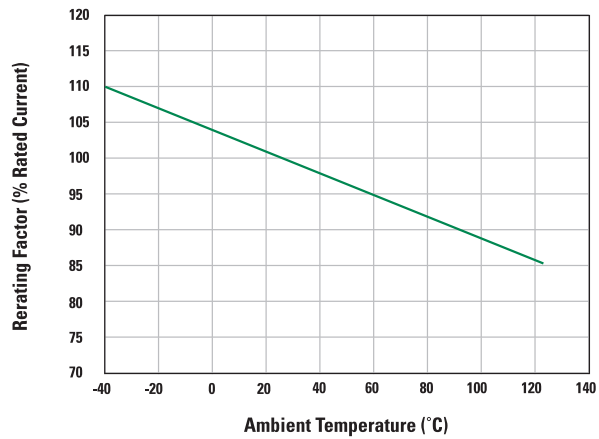

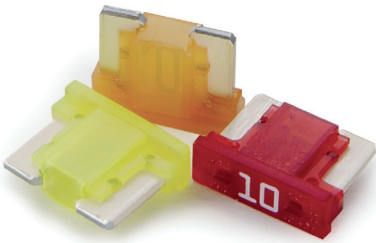

Low Profile MINI®  
Blade Fuses

## Low Profile MINI® Blade Fuses Rated 58V

The Low Profile MINI® fuse has similar performance characteristics as the standard MINI® fuse. The lower overall height allows for more space and weight savings. The Low Profile MINI® fuse is designed to mate with tuning-fork terminals, which provides additional weight and material savings in fuse box designs by eliminating the need for female box terminals.

### Specifications

Voltage Rating:	58 VDC
Interrupting Rating:	1000A @ 58 VDC
*Recommended Environmental Temperature:	-40°C to +125°C
Terminals Material:	Silver plated zinc
Housing Material:	PA66 (U.L. 94 Flammability rating – HB)
Net Weight Per Fuse:	0.4±15% gr
Complies with:	ISO 8820-9

\*Silver plating allows up to 150°C at the interface.



### Time-Current Characteristic Curves

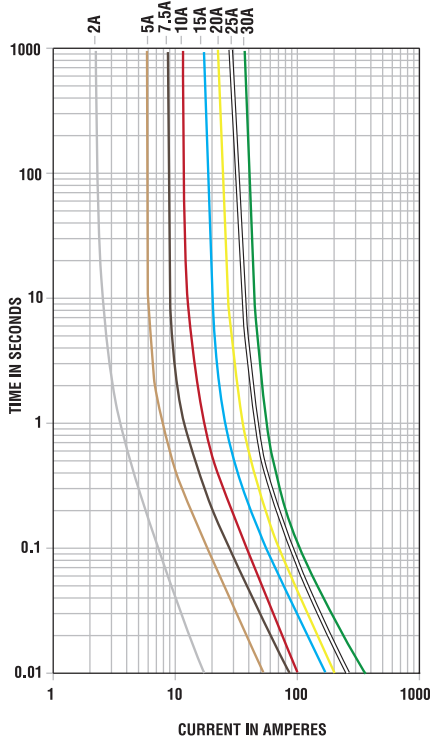

### Ordering Information

Part Number	Rating	Package Size
0891xxx.NXS	2 - 30	5000
0891xxx.U	2 - 30	500
0891xxx.H	2 - 30	100

### Time-Current Characteristics

% of Rating	Opening Time Min / Max (s)
110	360,000 / ∞
135	0.75 / 120
200	0.15 / 5
350	0.08 / 0.25
600	0.03 / 0.1

### Ratings

Part Number	Current Rating (A)	Housing Material Color	Test Cable Size (mm²)	Typ. Voltage Drop (mV)	Typ. Cold Resistance (mΩ)	Typ. I²t (A²s)
0891002_	2	Grey	0.5	151	54.2	3
0891005_	5	Orange	0.5	114	17.21	22
089107.5_	7.5	Brown	0.75	105	10.65	53
0891010_	10	Red	1	97	7.59	102
0891015_	15	Blue	1.5	75	4.70	198
0891020_	20	Yellow	2.5	99	3.35	420
0891025_	25	White	2.5	96	2.56	613
0891030_	30	Green	4	96	2.06	1,100

The typical I²t is an average value calculated from the breaking capacity tests by using the melting time before the arcing occurs.

## Low Profile MINI® Blade Fuses Rated 58V

### Dimensions

Dimensions in mm for reference only.  
See outline drawing for dimensions and tolerances.

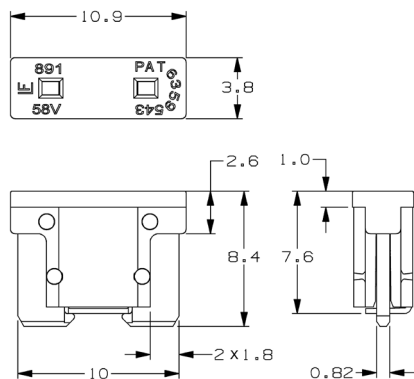

### Temperature Derating Curve

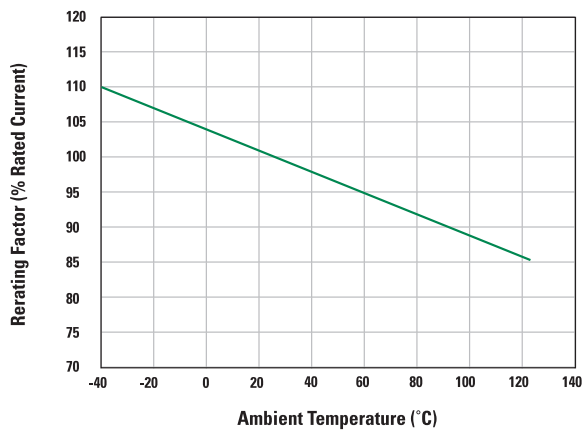

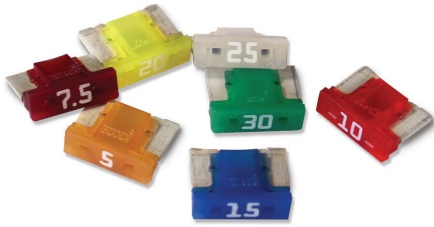

Low Profile MINI® 10.9mm  
Blade Fuses

## Low Profile MINI® 10.9 Blade Fuses Rated 58V

The Low Profile MINI® fuse has similar performance characteristics as the standard MINI® fuse. The lower overall height allows for more space and weight savings. The Low Profile MINI® fuse is designed to mate with tuning-fork terminals, which provides additional weight and material savings in fuse box designs by eliminating the need for female box terminals.

### Specifications

Voltage Rating:	58 VDC
Interrupting Rating:	1000A @ 58 VDC
*Recommended Environmental Temperature:	-40°C to +125°C
Terminals Material:	Silver plated zinc
Housing Material:	PA66 (U.L. 94 Flammability rating – HB)
Net Weight Per Fuse:	0.4±15% gr
Complies with:	ISO 8820-9

\*Silver plating allows up to 150°C at the interface.



### Time-Current Characteristic Curves

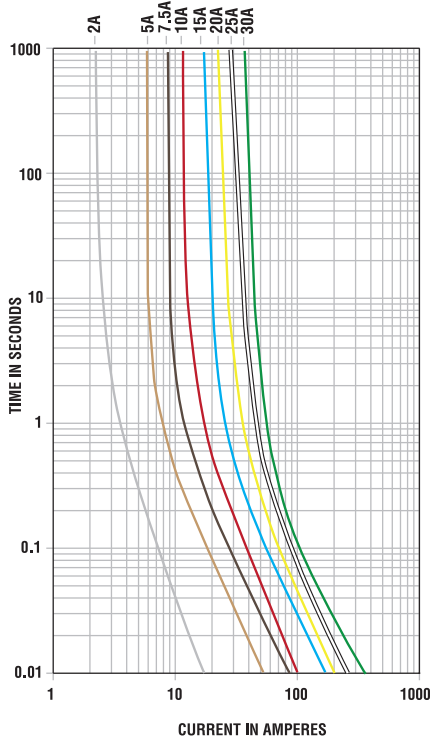







### Ordering Information

Part Number	Rating	Package Size
0891.xxx.NXWS	5 - 30	5000

### Time-Current Characteristics

% of Rating	Opening Time Min / Max (s)
110	360,000 / ∞
135	0.75 / 120
200	0.15 / 5
350	0.08 / 0.25
600	0.03 / 0.1

### Ratings

Part Number	Current Rating (A)	Housing Material Color	Test Cable Size (mm <sup>2</sup> )	Typ. Voltage Drop (mV)	Typ. Cold Resistance (mΩ)	Typ. I <sup>2</sup> t (A <sup>2</sup> s)
0891005_	5		0.5	114	17.21	22
089107.5_	7.5		0.75	105	10.65	53
0891010_	10		1	97	7.59	102
0891015_	15		1.5	75	4.70	198
0891020_	20		2.5	99	3.35	420
0891025_	25		2.5	96	2.56	613
0891030_	30		4	96	2.06	1,100

The typical I<sup>2</sup>t is an average value calculated from the breaking capacity tests by using the melting time before the arcing occurs.

## Low Profile MINI® 10.9 Blade Fuses Rated 58V

### Dimensions

Dimensions in mm for reference only.  
See outline drawing for dimensions and tolerances.

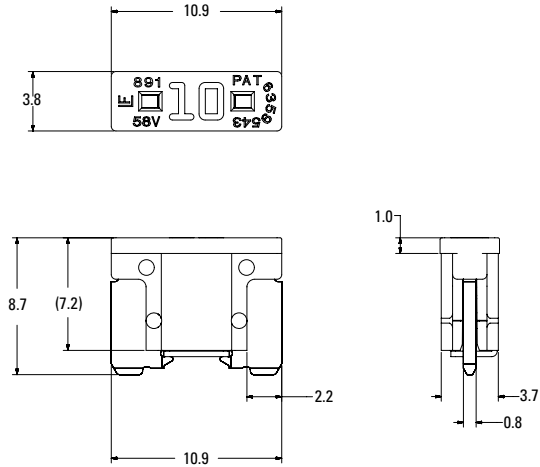

### Temperature Derating Curve

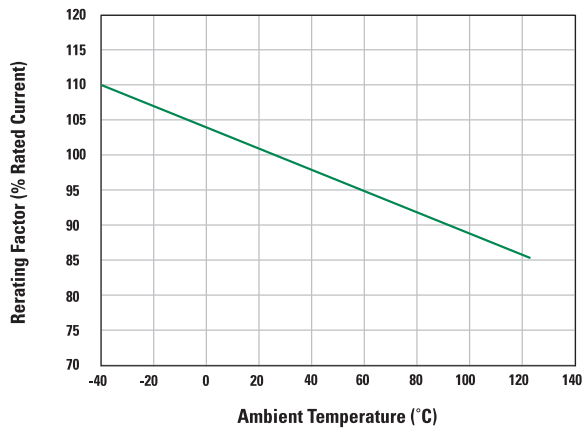

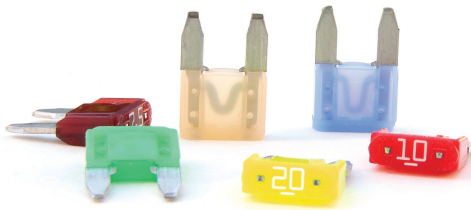

MINI® Blade Fuses



MINI® Shunt

## MINI® Blade Fuses Rated 32V

The MINI® Fuse is the standard for vehicle circuit protection. Its miniature design meets the need for more circuits to be protected while utilizing less space, and its ability to cope with high temperatures in adverse environments makes the MINI® Fuse of recommended choice for protection.

### Specifications

	MINI (Silver Plated)	MINI Sn (Tin Plated)
Voltage Rating:	32 VDC	32 VDC
Interrupting Rating:	1000A @ 32 VDC	1000A @ 32 VDC
*Recommended Environmental Temperature:	-40°C to +125°C	-40°C to +125°C
Terminals Material:	Silver plated zinc alloy	Tin plated zinc alloy
Housing Material:	PA66 (U.L. 94 Flammability rating – V2)	PA66 (U.L. 94 Flammability rating – V2)
Net Weight Per Fuse:	0.57±5% gr	0.57±5% gr
Complies with:	SAE J2077, ISO 8820-3, UL 248 Special Purpose Fuses	SAE J2077, ISO 8820-3 not UL recognized



\*Tin plating's temperature limit is =130°C. Silver plating allows up to 150°C at the terminal interface.

### Time-Current Characteristic Curves

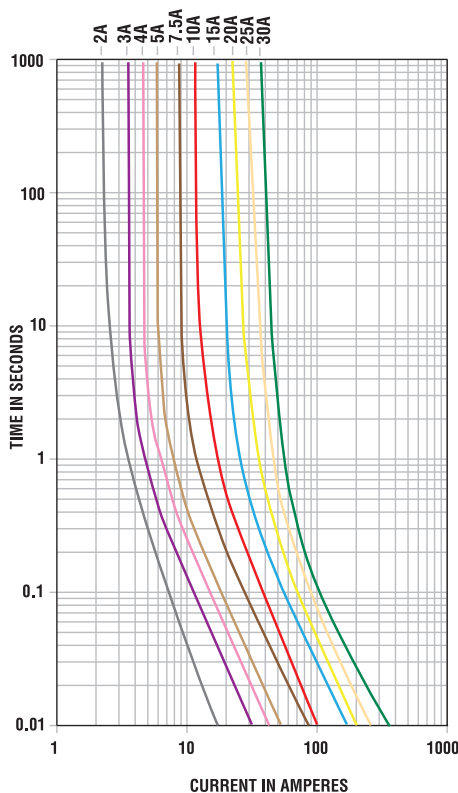

### Ordering Information

Part Number	Rating	Package Size
0297xxx.WXNV	2 - 30 & SHUNT	3000
0297xxx.WXNV-CN	5 - 30	3000
0297xxx.U	2 - 30	500
0297xxx.H	2 - 30	100
0297xxx.L	2 - 30	50

### MINI® Sn Fuse

0297xxx.WXT	2 - 30	3000
-------------	--------	------

### Time-Current Characteristics

% of Rating	Opening Time Min / Max (s)
110	360,000 / ∞
135	0.75 / 600
200	0.15 / 5
350	0.08 / 0.5
600	0.03 / 0.1

### Ratings

Part Number	Current Rating (A)	Housing Material Color	Test Cable Size (mm <sup>2</sup> )	Typ. Voltage Drop (mV)	Typ. Cold Resistance (mΩ)	Typ. I <sup>2</sup> t (A <sup>2</sup> s)
0297002_	2	Grey	0.5	171	55.60	2.8
0297003_	3	Purple	0.5	153	33.75	9.4
0297004_	4	Pink	0.5	121	23.48	17
0297005_	5	Brown	0.5	129	17.75	25
029707.5_	7.5	Dark Brown	0.75	135	10.85	68
0297010_	10	Red	1	108	7.42	93
0297015_	15	Blue	1.5	98	4.58	270
0297020_	20	Yellow	2.5	96	3.21	380
0297025_	25	Light Orange	2.5	86	2.36	625
0297030_	30	Green	4	87	1.85	1,100
0297900_	SHUNT	Black	-	-	-	-

The typical I<sup>2</sup>t is an average value calculated from the breaking capacity tests by using the melting time before the arcing occurs.



## MINI® Blade Fuses Rated 32V

### Dimensions

Dimensions in mm for reference only. See outline drawing for dimensions and tolerances.

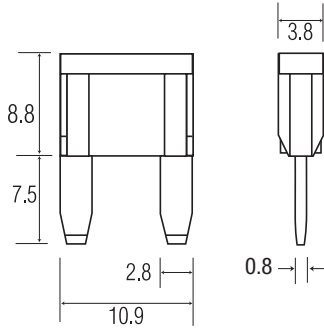

### Temperature Table

	max. allowed current load [A] at ambient temperature (typical derating)							
	-40°C	-20°C	0°C	20°C	40°C	60°C	80°C	100°C
<b>2A</b>	2.0	2.0	2.0	1.9	1.7	1.6	1.4	1.3
<b>3A</b>	3.0	2.8	2.7	2.5	2.4	2.2	2.0	1.8
<b>4A</b>	4.0	3.8	3.6	3.4	3.2	2.9	2.7	2.4
<b>5A</b>	5.0	4.8	4.5	4.3	4.0	3.7	3.4	3.0
<b>7.5A</b>	7.5	7.1	6.8	6.4	6.0	5.5	5.1	4.5
<b>10A</b>	10	10	9.8	9.2	8.6	8.0	7.3	6.5
<b>15A</b>	15	15	14	13	12	12	11	9.0
<b>20A</b>	20	19	18	17	16	15	14	12
<b>25A</b>	25	24	22	21	20	18	17	15
<b>30A</b>	30	29	27	26	24	22	20	18

MINI SHUNT Maximum Continuous Load at 85°C: 20A

### Typical Derating of Fuse Melting Element

Temperature Security Margin is 20%

Please contact Littelfuse® for Details Regarding Derating Test Set-Up.

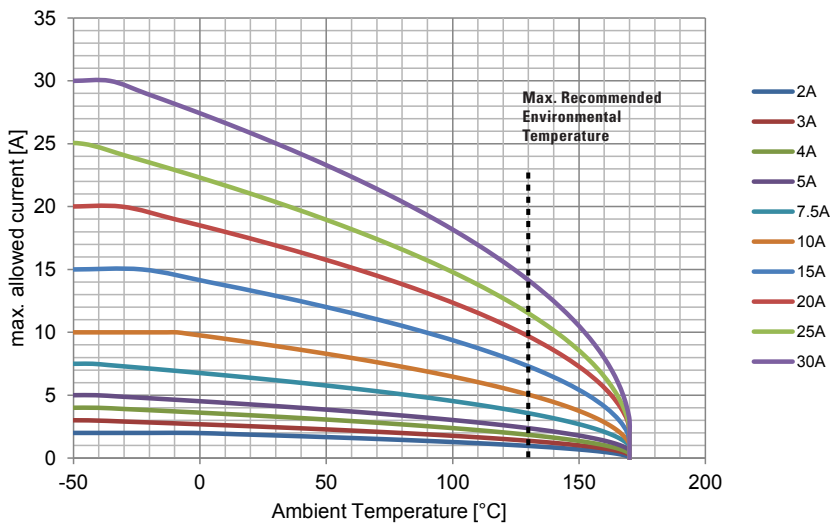

Derating curves may change depending on the final condition of the application (terminals characteristics, wire size etc.). Please ask Littelfuse® for more information.

## MINI® Blade Fuses Rated 58V

MINI® style fuse for use in 42V Systems. Same Time-Current characteristic as the 32V MINI® fuse. Fits into standard MINI® fuse sockets. Has a rejection feature to prevent fuses with lower voltage rating from being wrongfully inserted into the circuit. Current rating 2A - 30A @58 VDC max.

### Specifications

Voltage Rating:	58 VDC
Interrupting Rating:	1000A @ 58 VDC
*Recommended Environmental Temperature:	-40°C to +125°C
Terminals Material:	Silver plated zinc alloy
Housing Materials:	PA66 (U.L. 94 Flammability rating – V2)
Net Weight Per Fuse:	0.57±5% gr
Complies with:	SAE J2077, SAE 2576 ISO 8820 UL 248 Special Purpose Fuses



\*Silver plating allows up to 150°C at the terminal interface.



MINI® Blade Fuses

### Time-Current Characteristic Curves

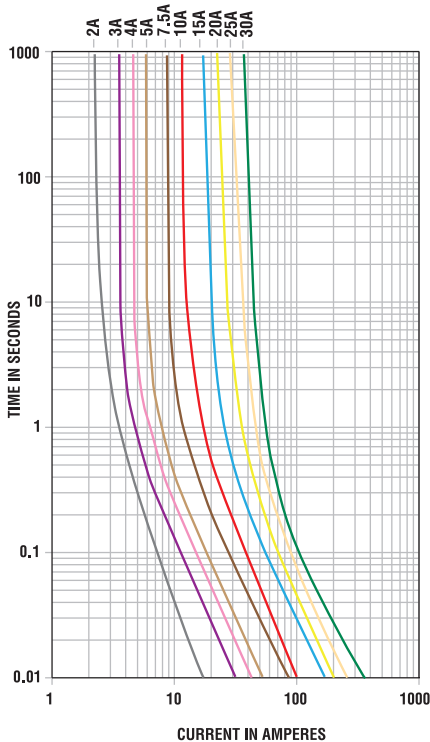

### Ordering Information

Part Number	Rating	Package Size
0997xxx.WXN	2 - 30	3000

### Time-Current Characteristics

% of Rating	Opening Time Min / Max (s)
110	360,000 / ∞
135	0.75 / 600
200	0.15 / 5
350	0.08 / 0.5
600	0.03 / 0.1

### Ratings

Part Number	Current Rating (A)	Housing Material Color	Test Cable Size (mm <sup>2</sup> )	Typ. Voltage Drop (mV)	Typ. Cold Resistance (mΩ)	Typ. I <sup>2</sup> t (A <sup>2</sup> s)
0997002_	2	Grey	0.5	171	55.60	2.8
0997003_	3	Purple	0.5	153	33.75	9.4
0997004_	4	Pink	0.5	121	23.48	17
0997005_	5	Brown	0.5	129	17.75	25
099707.5_	7.5	Dark Brown	0.75	135	10.85	68
0997010_	10	Red	1	108	7.42	93
0997015_	15	Blue	1.5	98	4.58	270
0997020_	20	Yellow	2.5	96	3.21	380
0997025_	25	Light Orange	2.5	86	2.36	625
0997030_	30	Green	4	87	1.85	1,100

The typical I<sup>2</sup>t is an average value calculated from the breaking capacity tests by using the melting time before the arcing occurs.

## MINI® Blade Fuses Rated 58V

### Dimensions

Dimensions in mm for reference only.  
See outline drawing for dimensions and tolerances.

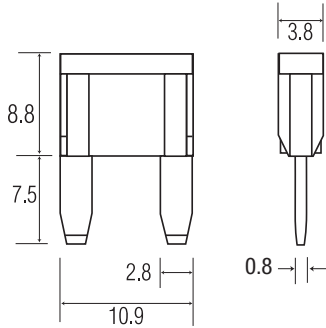

### Temperature Table

	max. allowed current load [A] at ambient temperature (typical derating)							
	-40°C	-20°C	0°C	20°C	40°C	60°C	80°C	100°C
<b>2A</b>	2.0	2.0	2.0	1.9	1.7	1.6	1.4	1.3
<b>3A</b>	3.0	2.8	2.7	2.5	2.4	2.2	2.0	1.8
<b>4A</b>	4.0	3.8	3.6	3.4	3.2	2.9	2.7	2.4
<b>5A</b>	5.0	4.8	4.5	4.3	4.0	3.7	3.4	3.0
<b>7.5A</b>	7.5	7.1	6.8	6.4	6.0	5.5	5.1	4.5
<b>10A</b>	10	10	9.8	9.2	8.6	8.0	7.3	6.5
<b>15A</b>	15	15	14	13	12	12	11	9.0
<b>20A</b>	20	19	18	17	16	15	14	12
<b>25A</b>	25	24	22	21	20	18	17	15
<b>30A</b>	30	29	27	26	24	22	20	18

### Typical Derating of Fuse Melting Element

Temperature Security Margin is 20%  
Please contact Littelfuse® for Details Regarding Derating Test Set-Up.

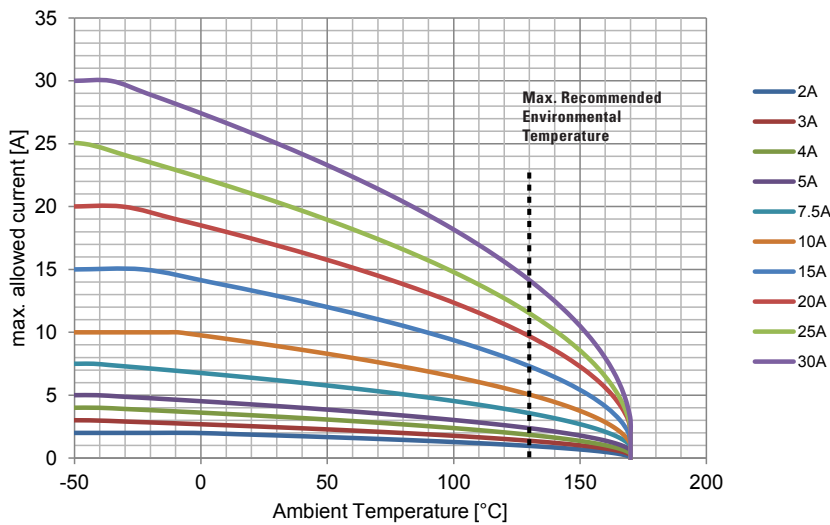

Derating curves may change depending on the final condition of the application (terminals characteristics, wire size etc.).  
Please ask Littelfuse® for more information.

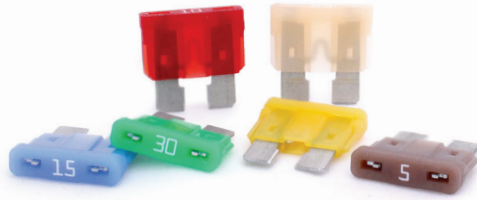

ATOF® Blade Fuses



ATO® Ag (Silver plated) Blade Fuses

## ATOF® Blade Fuses Rated 32V

Developed by Littelfuse for the automotive industry, the ATOF® fuse has become the original equipment circuit protection standard for foreign and domestic automobiles and trucks. Readily identifiable and easily replaced, this fuse can be specified for a variety of low voltage electronic applications.

### Specifications

	ATOF® (Tin Plated)	ATO Ag (Silver Plated)
Voltage Rating:	32 VDC	32 VDC
Interrupting Rating:	1000A @ 32 VDC	1000A @ 32 VDC
*Recommended Environmental Temperature:	-40°C to +125°C	-40°C to +125°C
Terminals Material:	Tin plated zinc alloy	Silver plated zinc alloy
Housing Material:	PA66 (U.L. 94 Flammability rating – V2)	PA66 (U.L. 94 Flammability rating – V2)
Net Weight Per Fuse:	1.4±5% gr	1.4±5% gr
Complies with:	SAE J1284,ISO 8820-3	SAE J1284,ISO 8820-3
UL Listed:	File AU1410	File AU1410
CSA Certified:	File No. 29862	File No. 29862



\*Tin plating's temperature limit is ≈130°C, Silver plating allows up to 150°C at the terminal interface.

### Ordering Information

Part Number	Rating	Package Size
<b>ATOF® (Tin Plated)</b>		
0287xxx.PXCN	1 - 40	2000
0287xxx.U	1 - 40	500
0287xxx.H	1 - 40	100
0287xxx.L	1 - 40	50
<b>ATO Ag (Silver Plated)</b>		
0287xxx.PXS	1 - 40	2000

### Time-Current Characteristics

% of Rating	Current Rating	Opening Time Min / Max (s)
100	35A & 40A	360,000 / ∞
110	1A-30A	360,000 / ∞
135	1A & 2A 3A-40A	0.35 / 600 0.750 / 600
160	1A-40A	0.250 / 50
200	1A & 2A 3A-40A	0.1 / 5 0.15 / 5
350	1A & 2A 3A-40A	0.02 / 0.5 0.08 / 0.5
600	1A-30A 35A & 40A	0.1 max 0.15 max

### Time-Current Characteristic Curves

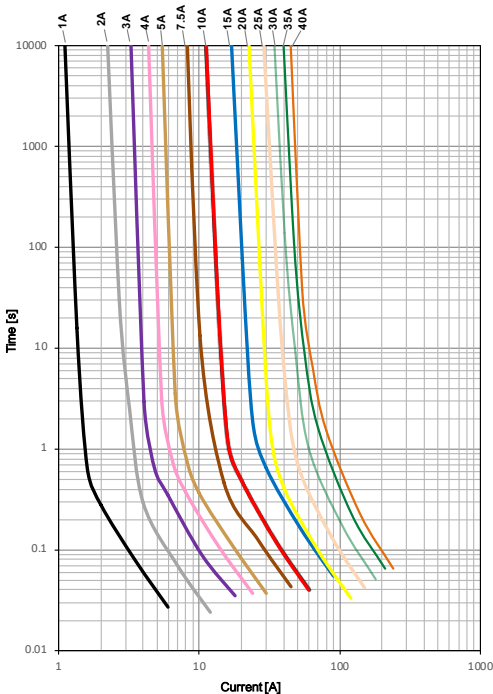

### Ratings

Part Number	Current Rating (A)	Housing Material Color	Test Cable Size (mm²)	Typ. Voltage Drop (mV)	Typ. Cold Resistance (mΩ)	Typ. I²t (A²s)
0287001_	1	Black	0.35	176	123	0.4
0287002_	2	Grey	0.35	141	53.5	1.4
0287003_	3	Purple	0.35	137	31.1	7.4
0287004_	4	Pink	0.35	136	22.8	14
0287005_	5	Brown	0.5	128	17.85	26
028707.5_	7.5	Dark Brown	0.75	116	10.91	60
0287010_	10	Red	1	109	7.70	115
0287015_	15	Blue	1.5	102	4.80	340
0287020_	20	Yellow	2.5	98	3.38	520
0287025_	25	Light Orange	2.5	92	2.52	1,000
0287030_	30	Green	4	84	1.97	1,500
0287035_	35	Dark Green	6	87	1.61	2,300
0287040_	40	Orange	6	96	1.44	3,300

The typical I²t is an average value calculated from the breaking capacity tests by using the melting time before the arcing occurs.

## ATOF® Blade Fuses Rated 32V

### Dimensions

Dimensions in mm for reference only.  
See outline drawing for dimensions and tolerances.

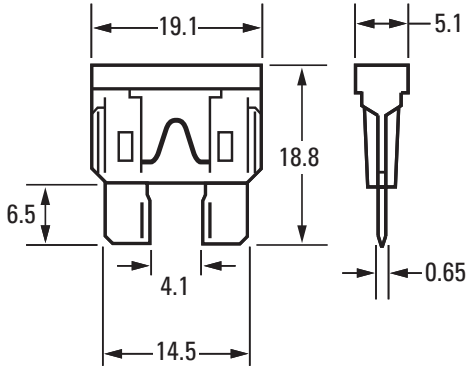

### Temperature Table

	max. allowed current load [A] at ambient temperature (typical derating)						
	-40°C	0°C	20°C	65°C	85°C	110°C	125°C
1A	1	1	1	1	1	1	1
2A	2	2	2	2	2	1	1
3A	3	3	3	3	2	2	2
4A	4	4	4	3	3	3	2
5A	5	5	5	4	4	3	3
7.5A	8	7	7	6	5	5	4
10A	10	10	10	8	7	6	5
15A	15	15	14	12	11	9	8
20A	20	19	18	15	14	12	10
25A	25	25	23	19	18	15	13
30A	30	29	27	23	21	18	15
35A	35	35	35	29	27	22	19
40A	40	39	37	31	28	24	20

### Typical Derating of Fuse Melting Element

Temperature Security Margin is 20%

Wire Cross Section And Fixture Test Set Up Refer To ISO 8820-3

Please Contact Littelfuse® For Details Regarding Derating Test Set Up

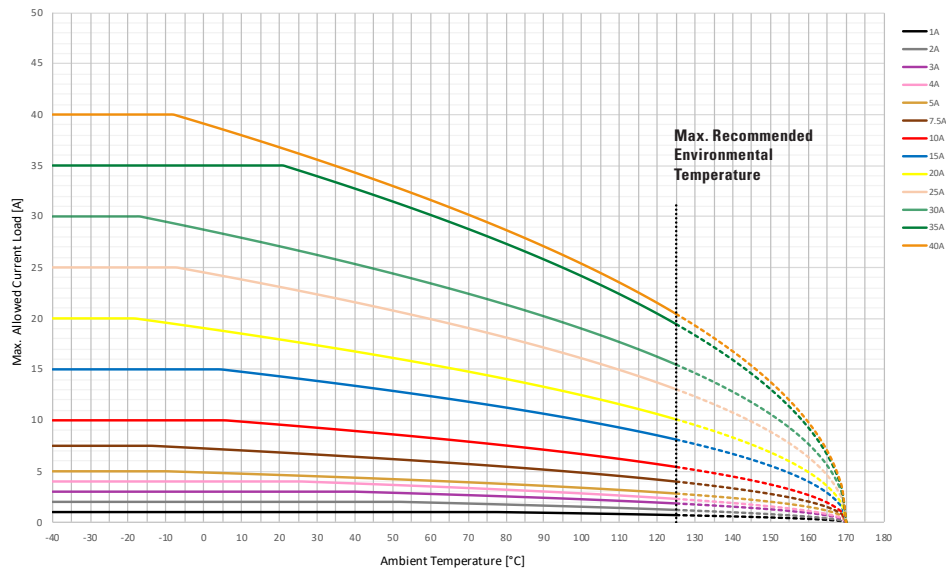

Derating curves may change depending on the final condition of the application (terminals characteristics, wire size etc...). Please ask Littelfuse® for more information.

## MAXI Blade Fuses Rated 32V

The MAXI® fuse uses “Diffusion Pill Technology” to provide predictable time delay characteristics and low heat dissipation.

### Specifications

Voltage Rating:  
Interrupting Rating:  
\*Recommended Environmental Temperature:  
Terminals Material:  
Housing Material:

**MAXI  
(Silver Plated)**  
32 VDC  
1000A @ 32 VDC  
-40°C to +125°C  
Silver plated zinc alloy  
PA66  
(U.L. 94 Flammability rating – V2)  
5.7±5% gr  
SAE J 1888, SAE 2576,  
ISO 8820-3:2002(E)

**MAXI Sn  
(Tin Plated)**  
32 VDC  
1000A @ 32 VDC  
-40°C to +125°C  
Tin plated zinc alloy  
PA66  
(U.L. 94 Flammability rating – V2)  
5.7±5% gr  
SAE J 1888, SAE 2576,  
ISO 8820-3:2002(E)

Net Weight Per Fuse:  
Complies with:

\*Tin plating's temperature limit is ~130°C, Silver plating allows up to 150°C at the interface.



MAXI Blade Fuses



MAXI Sn Fuse (tin plated)

### Time-Current Characteristic Curves

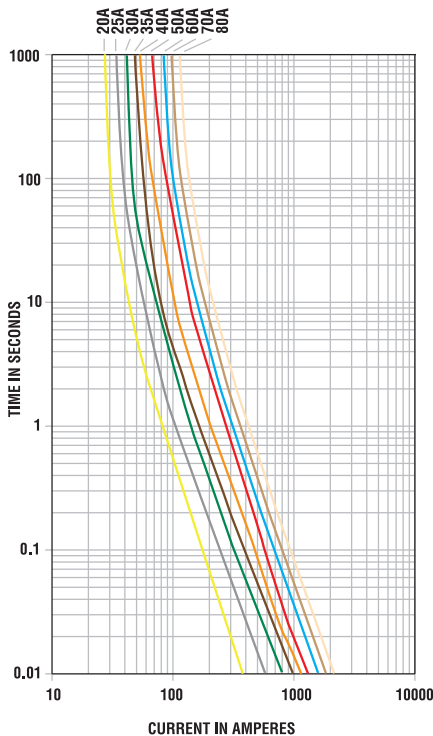

### Ordering Information

Part Number	Rating	Package Size
0299xxx.ZXNV	20 - 80	1200
0299xxx.L	20 - 80	50
0299xxx.TXN	20 - 80	10
<b>MAXI Sn Fuse</b>		
0299xxx.ZXT	20 - 80	1200

### Time-Current Characteristics

% of Rating	Opening Time Min / Max (s)
100	360,000 / ∞
135	60 / 1,800
200	2 / 60
350	0.2 / 7
600	0.04 / 1

### Ratings

Part Number	Current Rating (A)	Housing Material Color	Test Cable Size (mm <sup>2</sup> )	Typ. Voltage Drop (mV)	Typ. Cold Resistance (mΩ)	Typ. I <sup>2</sup> t (A <sup>2</sup> s)
0299020_	20	Yellow	4	76	3.10	1,100
0299025_	25	Grey	4	75	2.39	2,100
0299030_	30	Green	4	77	1.95	4,100
0299035_	35	Brown	4	75	1.71	6,000
0299040_	40	Orange	4	75	1.42	8,500
0299050_	50	Red	6	73	1.10	11,300
0299060_	60	Blue	6	77	0.89	15,300
0299070_	70	Tan	10	61	0.64	21,200
0299080_	80	Light Orange	10	62	0.54	43,600

The typical I<sup>2</sup>t is an average value calculated from the breaking capacity tests by using the melting time before the arcing occurs.

## MAXI Blade Fuses Rated 32V

### Dimensions

Dimensions in mm for reference only.  
See outline drawing for dimensions and tolerances.

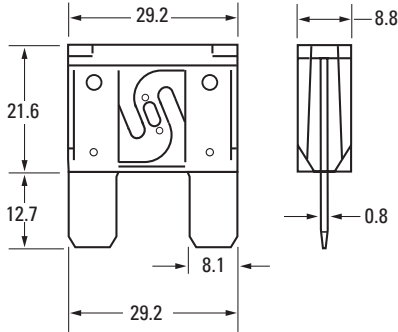

### Temperature Table

	max. allowed current load [A] at ambient temperature (typical derating)						
	-40°C	0°C	20°C	65°C	85°C	110°C	125°C
<b>20A</b>	20	20	20	20	18	15	13
<b>25A</b>	25	25	25	23	21	18	15
<b>30A</b>	30	30	30	28	25	21	18
<b>35A</b>	35	35	35	30	27	23	19
<b>40A</b>	40	40	40	34	30	25	22
<b>50A</b>	50	50	50	42	38	31	27
<b>60A</b>	60	60	56	47	42	35	31
<b>70A</b>	70	70	68	57	51	43	37
<b>80A</b>	80	78	74	62	56	47	40

### Typical Derating of Fuse Melting Element

Temperature Security Margin is 20%  
Please contact Littelfuse® for Details Regarding Derating Test Set-Up.

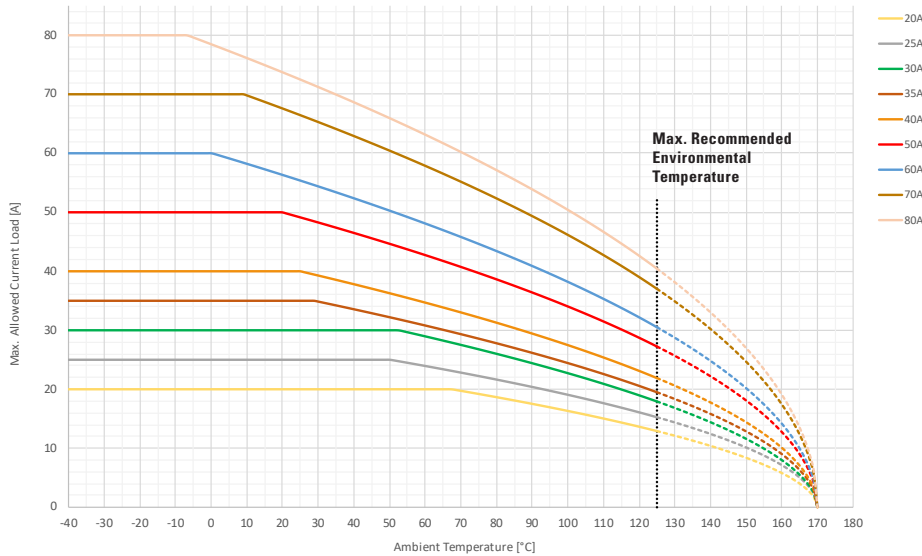

Derating curves may change depending on the final condition of the application (terminals characteristics, wire size etc.).  
Please ask Littelfuse® for more information.

## MAXI Blade Fuses Rated 58V

The MAXI® style fuse for use in 42V Systems. Same Time-Current characteristic as the 32V MAXI fuse using “Diffusion Pill Technology” to provide predictable time delay characteristics and low heat dissipation. Fits into standard MAXI® fuse sockets. Has a rejection feature to prevent fuses with lower voltage rating from being wrongfully inserted into the circuit. Current rating 20A - 80A @58 VDC max.



MAXI Blade Fuses

### Specifications

Voltage Rating:	58 VDC
Interrupting Rating:	1000A @ 58 VDC
*Recommended Environmental Temperature:	-40°C to +125°C
Terminals Material:	Silver plated zinc alloy
Housing Material:	PA66 (U.L. 94 Flammability rating – V2)
Net Weight Per Fuse:	5.7±5% gr
Complies with:	SAE J 1888, SAE 2576 ISO 8820-3:2002(E)



\*Silver plating allows up to 150°C at the terminal interface.

### Time-Current Characteristic Curves

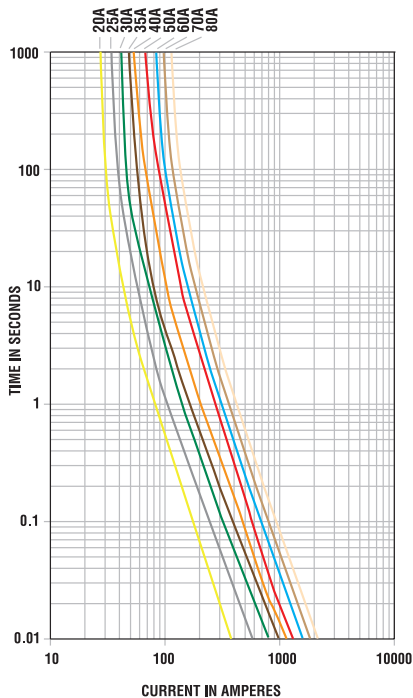

### Ordering Information

Part Number	Rating	Package Size
0999xxx.ZXN	20 - 80	1200

### Time-Current Characteristics

% of Rating	Opening Time Min / Max (s)
110	360,000 / ∞
135	60 / 1,800
200	2 / 60
350	0.2 / 7
600	0.04 / 1

### Ratings

Part Number	Current Rating (A)	Housing Material Color	Test Cable Size (mm <sup>2</sup> )	Typ. Voltage Drop (mV)	Typ. Cold Resistance (mΩ)	Typ. I <sup>2</sup> t (A <sup>2</sup> s)
0999020_	20	Yellow	4	76	3.10	1,100
0999025_	25	Grey	4	75	2.39	2,100
0999030_	30	Green	4	77	1.95	4,070
0999035_	35	Brown	4	75	1.71	6,00
0999040_	40	Orange	4	75	1.42	8,500
0999050_	50	Red	6	73	1.10	11,300
0999060_	60	Blue	6	77	0.89	15,300
0999070_	70	Tan	10	61	0.64	21,200
0999080_	80	Light Orange	10	62	0.54	43,600

The typical I<sup>2</sup>t is an average value calculated from the breaking capacity tests by using the melting time before the arcing occurs.



## MAXI Blade Fuses Rated 58V

### Dimensions

Dimensions in mm for reference only.  
See outline drawing for dimensions and tolerances.

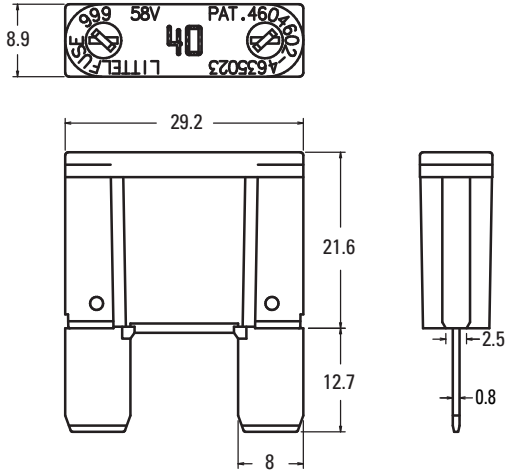

### Temperature Table

	max. allowed current load [A] at ambient temperature (typical derating)						
	-40°C	0°C	20°C	65°C	85°C	110°C	125°C
<b>20A</b>	20	20	20	20	18	15	13
<b>25A</b>	25	25	25	23	21	18	15
<b>30A</b>	30	30	30	28	25	21	18
<b>35A</b>	35	35	35	30	27	23	19
<b>40A</b>	40	40	40	34	30	25	22
<b>50A</b>	50	50	50	42	38	31	27
<b>60A</b>	60	60	56	47	42	35	31
<b>70A</b>	70	70	68	57	51	43	37
<b>80A</b>	80	78	74	62	56	47	40

### Typical Derating of Fuse Melting Element

Temperature Security Margin is 20%  
Please Contact Littelfuse® for Details Regarding Derating Test Set-Up.

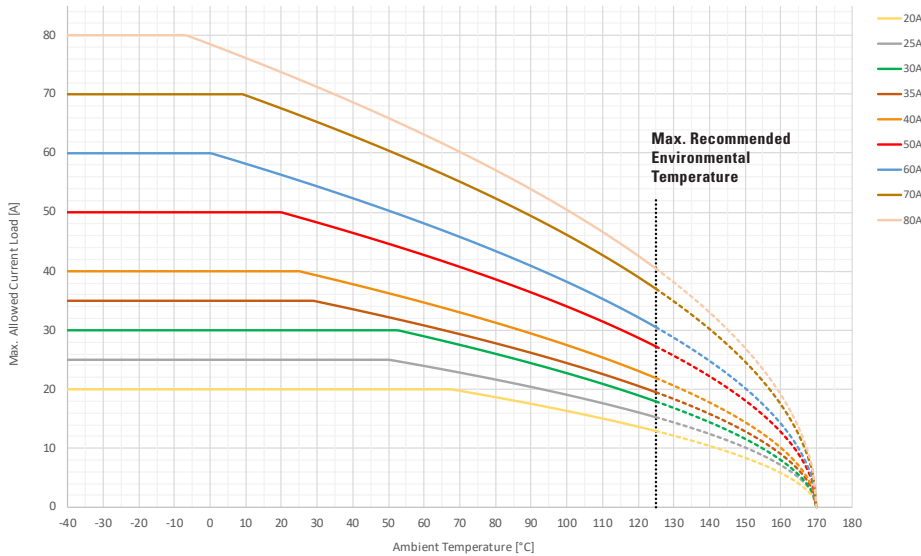

Derating curves may change depending on the final condition of the application (terminals characteristics, wire size etc.).  
Please ask Littelfuse® for more information.



MAXI+ Blade Fuses

## MAXI+® Blade Fuses Rated 32V

The MAXI+® Fuse is new standard for vehicle circuit protection. Its miniature design meets the need for more circuits to be protected while utilizing less space, and its ability to cope with high temperatures in adverse environments makes the MAXI+® Fuse of recommended choice for protection.

### Specification

Voltage Rating:	32 VDC
Interrupting Rating:	1000A @ 32 VDC
*Recommended Environmental Temperature:	-40°C to +125°C
Terminals Material:	Silver plated zinc alloy
Housing Material:	PA66 (U.L. 94 Flammability rating – V2)
Net Weight Per Fuse:	2±10% gr
Refers to:	ISO 8820-10:2020

### RoHS

\*Silver plating allows up to 150°C at the terminal interface.

### Time-Current Characteristic Curves

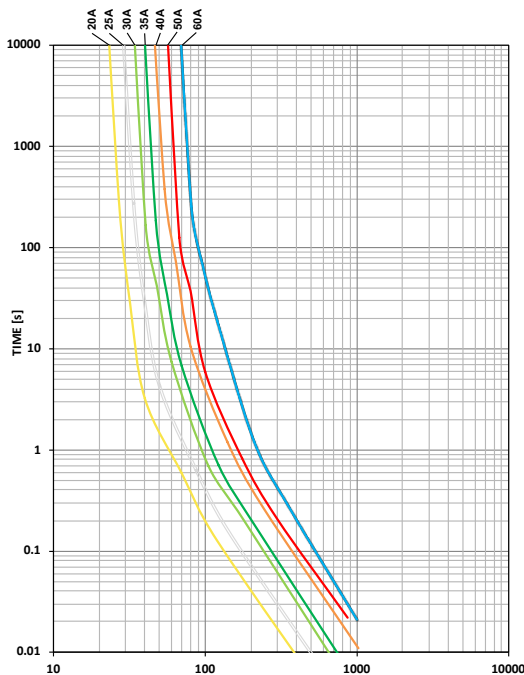

### Ordering Information

Part Number	Rating	Package Size
0899xxx.Z	20-60	1000

### Time-Current Characteristics

% of Rating	Opening Time Min / Max (s)
100	360,000 / ∞
135	60 / 900
160	10 / 100
200	2 / 50
350	0.2 / 7
600	0.04 / 1

### Ratings

Part Number	Current Rating (A)	Housing Material Color	Test Cable Size (mm <sup>2</sup> )	Typ. Voltage Drop (mV)	Typ. Cold Resistance (mΩ)	I <sup>2</sup> t (A <sup>2</sup> s)
0899020.Z	20	Yellow	1.5	80	3.0	1,300
0899025.Z	25	White	2.5	77	2.3	2,200
0899030.Z	30	Light Green	2.5	60	1.7	3,900
0899035.Z	35	Dark Green	4	58	1.2	4,900
0899040.Z	40	Orange	4	55	1.0	9,400
0899050.Z	50	Red	6	50	0.7	16,500
0899060.Z	60	Blue	6	62	0.5	17,500

The I<sup>2</sup>t value is calculated from the breaking capacity tests by using the current time profile before the arcing occurs.

## MAXI+® Blade Fuses Rated 32V

### Dimensions

Dimensions in mm for reference only. See outline drawing for dimensions and tolerances.

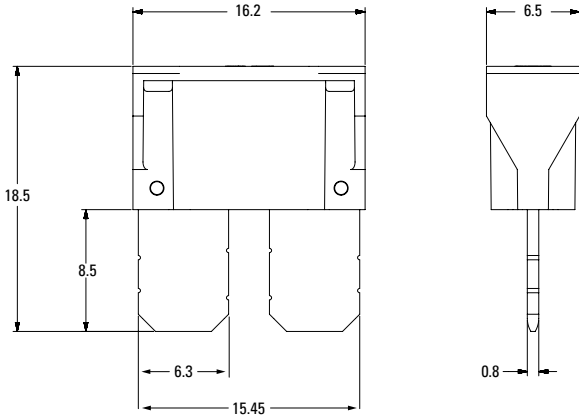

### Temperature Table

	max. allowed current load [A] at ambient temperature (typical derating)						
	-40°C	0°C	20°C	65°C	85°C	110°C	125°C
<b>20A</b>	20	20	20	17	15	13	11
<b>25A</b>	25	25	25	21	19	16	14
<b>30A</b>	30	30	30	26	24	20	17
<b>35A</b>	35	35	35	33	29	24	21
<b>40A</b>	40	40	40	36	32	27	23
<b>50A</b>	50	50	50	42	38	32	27
<b>60A</b>	60	60	56	47	42	36	31

### Typical Derating Of Fuse Melting Element

Temperature Security Margin is 20%

Wire Cross Section And Fixture Test Set Up Refer To ISO 8820-10:2020

Please contact Littelfuse® for details regarding Derating Test Set Up.

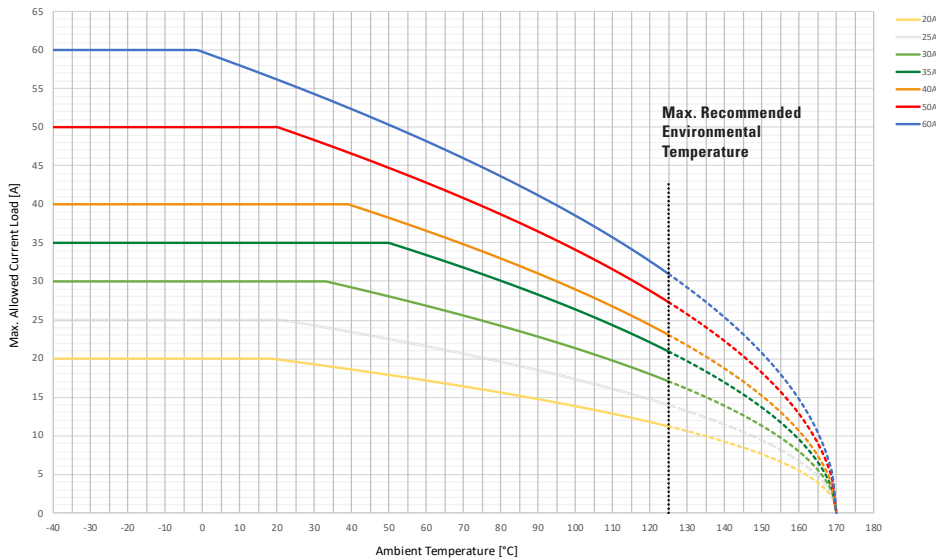

Derating curves may change depending on the final condition of the application (terminals characteristics, wire size etc..). Please ask Littelfuse® for more information

## CARTRIDGE FUSES

---

MCASE+ Cartridge Fuses Rated 32V	23
Low Profile JCASE <sup>®</sup> Fuse Rated 58V	26
JCASE <sup>®</sup> Fuse Rated 32V	28

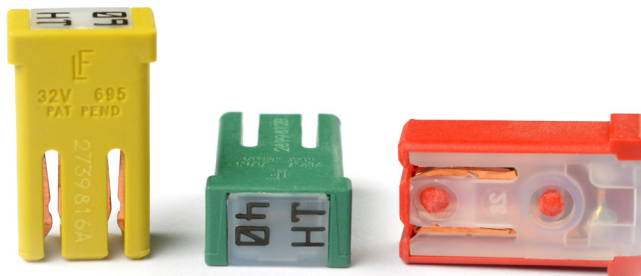

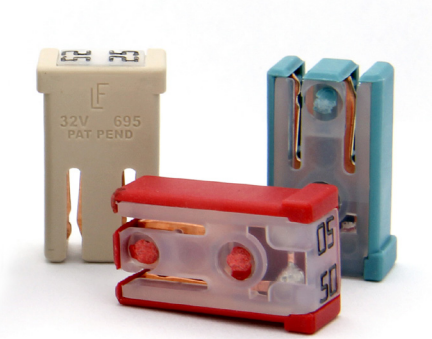

MCASE+™ Slotted

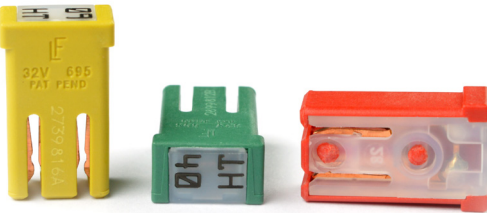

MCASE+™ Slotted HT

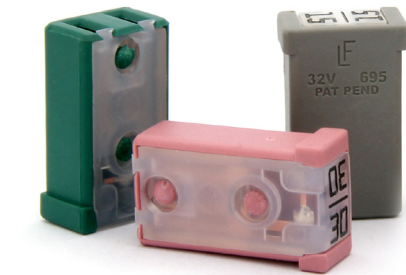

MCASE+™ Unslotted



MCASE+™ Unslotted HT

## MCASE+™ Cartridge Fuses Rated 32V

MCASE+™ is a time delayed fuse designed to withstand inrush currents within a miniaturized footprint for optimal performance in minimal space. The Unslotted MCASE+™ cartridge style fuse can protect up to 40A with female terminals for 2.8 mm male terminals. The Slotted MCASE+™ Fuse is rated up to 60A and can mate with 6.3mm male terminals or even mount performance in minimal space directly onto a busbar. MCASE+ High Temperature (HT) have a lower voltage drop and are designed to operate with a lower temperature rise in harsher environmental applications.

### Specification

Voltage Rating	32VDC
Interrupting Rating:	1000 @ 32VDC
Recommended Environmental Temperature:	-40°C to +125°C
Housing Material:	PPA-GF33 (U.L. 94 Flammability rating - HB)
Cover Material:	PA66 (U.L. 94 Flammability rating - V2)
Net Weight Per Fuse:	1.15g ±10%
Fuse Insertion Force:	50N (11.2 lb) - Typical
Extraction Force:	4N Min. (0.9 lb) / 24.5N Max (5.5 lb) - Single Terminal
Complies with:	SAE 2741 and ISO 8820-4 in reference to electrical, mechanical and environmental performance requirements.

### RoHS

### Ordering Information

Part Number	Type	Rating	Package Size
0695xxx.PXPS	Slotted	15-60	2000
0695xxx.PXPS-HT	Slotted	40-60	2000
0695xxx.PXP	Unslotted	15-40	2000
0695xxx.PXP-HT	Unslotted	40	2000

### Time-Current Characteristics

% of Rating	Opening Time Min / Max (s)
110	360,000 / ∞
135	60 / 1,800
200	2 / 60
350	0.2 / 7
600	0.04 / 1

### Ratings

Part Number	Type	Current Rating (A)	Housing Material Color	Test Cable Size (mm <sup>2</sup> )	Typ. Voltage Drop (mV)	Typ. Cold Resistance (mΩ)	Typ. I <sup>2</sup> t (A <sup>2</sup> s)
0695015.PXPS	Slotted	15	Grey	1.25	97	4.8	295
0695020.PXPS	Slotted	20	Blue	1.25	100	3.4	570
0695025.PXPS	Slotted	25	Yellow	2	99	2.5	1,370
0695030.PXPS	Slotted	30	Pink	2	112	1.8	1,030
0695040.PXPS	Slotted	40	Green	3	107	1.1	1,400
0695050.PXPS	Slotted	50	Red	5	109	0.77	3,800
0695060.PXPS	Slotted	60	Yellow	5	102	0.54	8,000
0695040.PXPS-HT	Slotted	40	Green	3	111	0.89	2,500
0695050.PXPS-HT	Slotted	50	Red	5	74	0.64	5,700
0695060.PXPS-HT	Slotted	60	Yellow	5	90	0.46	13,000
0695015.PXP	Unslotted	15	Grey	1.25	97	4.8	300
0695020.PXP	Unslotted	20	Blue	1.25	106	3.4	600
0695025.PXP	Unslotted	25	Yellow	2	114	2.5	1,200
0695030.PXP	Unslotted	30	Pink	2	96	1.8	1,000
0695040.PXP	Unslotted	40	Green	3	101	1	1,700
0695040.PXP-HT	Unslotted	40	Green	3	109	0.89	2,500

Please Note: The performance of the male terminal is critical to ensuring the fuse will function as designed. The current carrying capability of the mating terminal must be verified to ensure proper system operation. Fixture Test Set Up Refer To ISO 8820 4 (Plated Mating Tab Terminals). Please contact Littelfuse® for details regarding Test Set Up Definition.

The typical I<sup>2</sup>t is an average value calculated from the breaking capacity tests by using the melting time before the arcing occurs.

## MCASE+™ Cartridge Fuses Rated 32V

### Dimensions

Dimensions in mm for reference only. See outline drawing for dimensions and tolerances.

### MCASE+™ Slotted

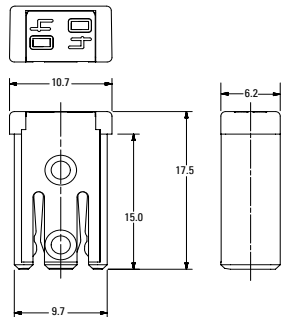

### Slotted Recommended Mating Cavity

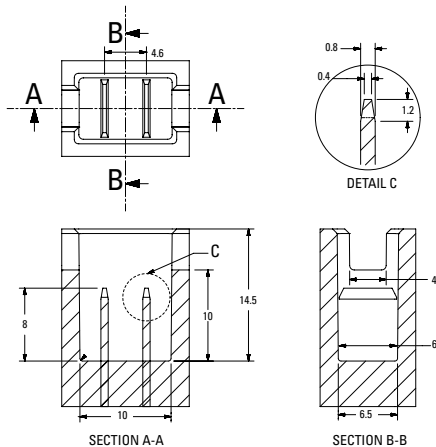

### Time-Current Characteristic Curves

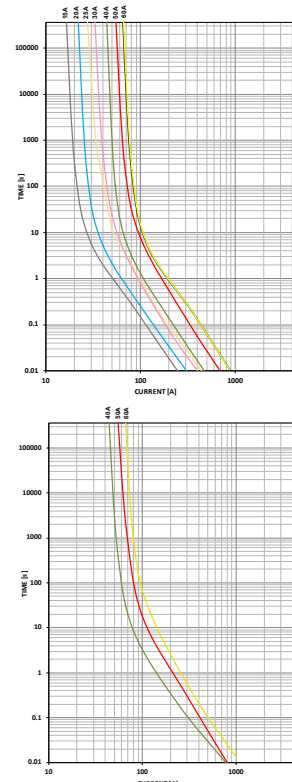

### MCASE+™ Slotted HT

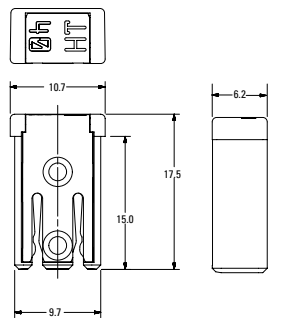

### MCASE+™ Unslotted

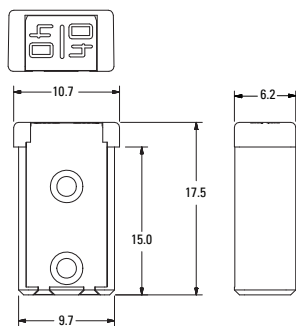

### Unslotted Recommended Mating Cavity

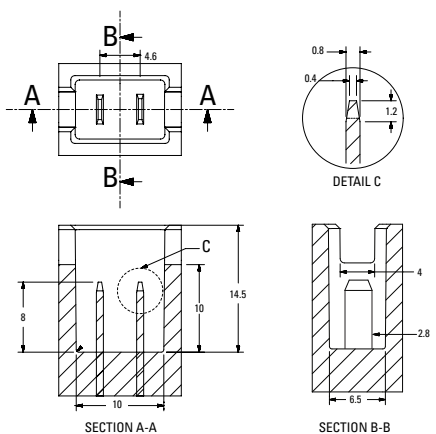

### Time-Current Characteristic Curves

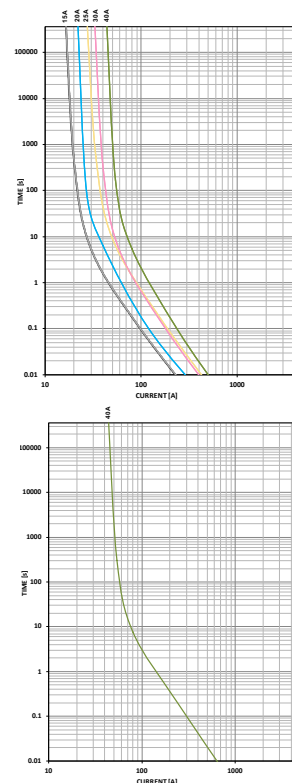

### MCASE+™ Unslotted HT

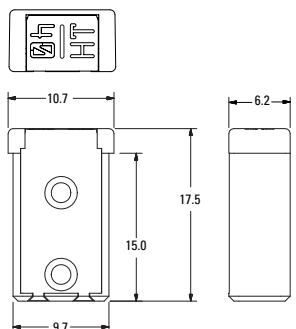

**Recommended MCASE Fuse Puller**  
MATERIAL NUMBER 00970054XPA

REV07082021

## MCASE+™ Cartridge Fuses Rated 32V

### Typical Derating Of Fuse Melting Element

Temperature Security Margin is 20%  
 Fixture Test Set Up Refer To ISO 8820-4 With (Plated Mating Tab Terminals)  
 Please contact Littelfuse® for details regarding derating test set up.

### MCASE+™ Slotted

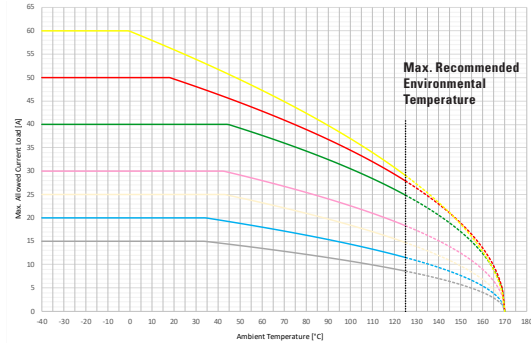

### Temperature Table

	max. allowed current load [A] at ambient temperature)						
	-40°C	0°C	20°C	65°C	85°C	110°C	125°C
<b>15A</b>	15	15	15	13	12	10	9
<b>20A</b>	20	20	20	18	16	13	12
<b>25A</b>	25	25	25	23	20	17	15
<b>30A</b>	30	30	30	27	25	21	18
<b>40A</b>	40	40	40	37	33	28	25
<b>50A</b>	50	50	50	42	38	32	28
<b>60A</b>	60	60	56	46	41	34	29

### MCASE+™ Slotted HT

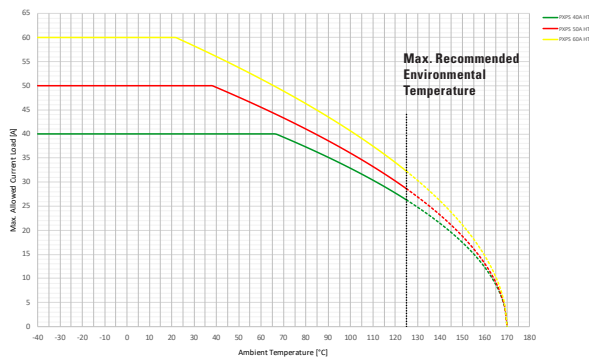

### Temperature Table

	max. allowed current load [A] at ambient temperature)						
	-40°C	0°C	20°C	65°C	85°C	110°C	125°C
<b>40A HT</b>	40	40	40	40	36	30	26
<b>50A HT</b>	50	50	50	44	40	33	29
<b>60A HT</b>	60	60	60	50	45	37	32

### MCASE+™ Unslotted

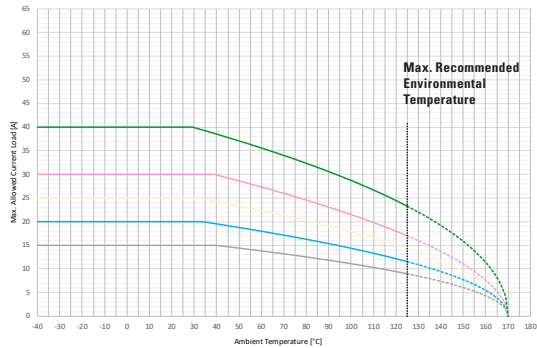

### Temperature Table

	max. allowed current load [A] at ambient temperature)						
	-40°C	0°C	20°C	65°C	85°C	110°C	125°C
<b>15A</b>	15	15	15	14	12	10	9
<b>20A</b>	20	20	20	18	16	13	12
<b>25A</b>	25	25	25	22	20	17	14
<b>30A</b>	30	30	30	27	24	20	17
<b>40A</b>	40	40	40	35	31	27	23

### MCASE+™ Unslotted HT

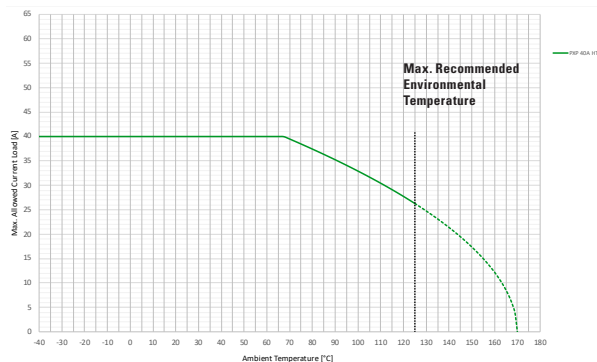

### Temperature Table

	max. allowed current load [A] at ambient temperature)						
	-40°C	0°C	20°C	65°C	85°C	110°C	125°C
<b>40A HT</b>	40	40	40	40	36	30	26

Derating curves may change depending on the final condition of the application (terminals characteristics, wire size etc.).  
 Please ask Littelfuse® for more information.



Low Profile JCASE®  
Cartridge Fuses

## Low Profile JCASE® Cartridge Fuses Rated 58V

The Low Profile JCASE® fuse has similar performance characteristics as the standard JCASE® fuse. The lower overall height reduction allows for more space and weight savings and also allows for a shorter male blade terminal, saving additional weight and material savings in fuse box designs.

### Specifications

Voltage Rating:	58 VDC
Interrupting Rating:	1000A @ 58 VDC
Recommended Environmental Temperature:	-40°C to + 125°C
Housing Material:	PA66-GF13 (U.L. 94 Flammability rating – HB)
Cover Material:	PSU (U.L. 94 Flammability rating – HB)
New Weight Per Fuse:	2.4g ±10%
Insertion Force:	53N Max. (12 lb.)
Extraction Force:	9N Min (2 lb.)
Complies With:	SAE 2741 and ISO 8820-4 except for the life test – LF specification is 100-hours at 100% of rated current

**RoHS**

### Time-Current Characteristic Curves

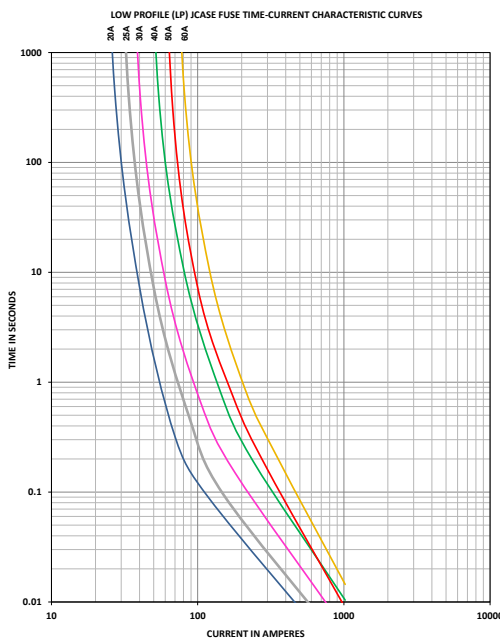

### Ordering Information

Part Number	Rating	Package Size
0895xxx.Z	20 - 60	2000
0895xxx.U	20 - 60	500
0895xxx.T	20 - 60	10

### Time-Current Characteristics

% of Rating	Opening Time Min / Max (s)
100	360,000 / ∞
135	60 / 1800
200	4 / 60
350	0.2 / 7
600	0.04 / 1

### Ratings

Part Number	Current Rating (A)	Housing Material Color	Test Cable Size (mm <sup>2</sup> )	Typ. Voltage Drop (mV)	Typ. Cold Resistance (mΩ)	Typ. I <sup>2</sup> t (A <sup>2</sup> s)
0895020_	20	Blue	4	104	4.48	400
0895025_	25	White	4	113	3.39	680
0895030_	30	Pink	4	107	2.68	1,800
0895040_	40	Green	4	102	1.89	5,500
0895050_	50	Red	6	96	1.08	4,900
0895060_	60	Yellow	6	96	0.83	9,600

The typical I<sup>2</sup>t is an average value calculated from the breaking capacity tests by using the melting time before the arcing occurs.



## Low Profile JCASE® Cartridge Fuses Rated 58V

### Dimensions

Dimensions in mm

Dimensions in mm for reference only. See outline drawing for dimensions and tolerances.

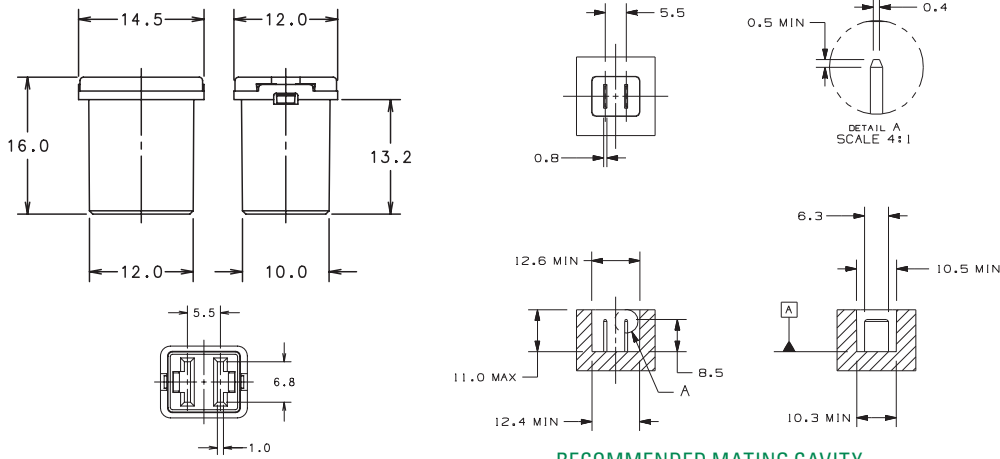

### RECOMMENDED MATING CAVITY

(Please refer to the OL drawing for further details)

### Typical Derating of Fuse Melting Element

Temperature Security Margin is 20%

Please Contact Littelfuse® for Details Regarding Derating Test Set-Up

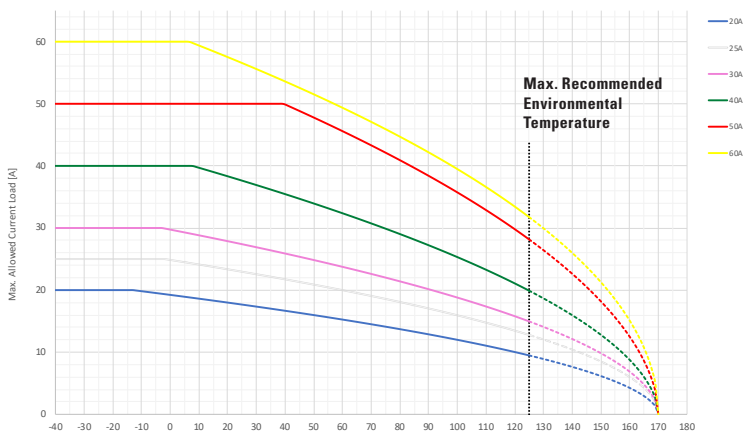

### Temperature Table

	max. allowed current load [A] at ambient temperature (typical derating)						
	-40°C	0°C	20°C	65°C	85°C	110°C	125°C
<b>20A</b>	20	19	18	15	13	11	9
<b>25A</b>	25	25	23	20	18	15	13
<b>30A</b>	30	30	28	23	21	17	15
<b>40A</b>	40	40	38	32	28	23	20
<b>50A</b>	50	50	50	44	40	33	28
<b>60A</b>	60	60	58	48	43	37	32

Derating curves may change depending on the final condition of the application (terminals characteristics, wire size etc.). Please ask Littelfuse for more information.



JCASE®  
Cartridge Fuses

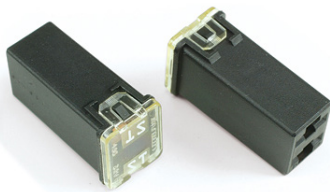

JCASE® Shunt

## JCASE® Cartridge Fuses Rated 32V

The JCASE® is a cartridge style fuse with female terminal design. JCASE® provides both increased time delay and low voltage drop to protect high current circuits. JCASE® has the ability to handle inrush currents.

### Specifications

Voltage Rating:	32 VDC
Interrupting Rating:	1000A @ 32 VDC
Recommended Environmental Temperature:	-40°C to +125°C
Housing Material:	PA66-GF13 (U.L. 94 Flammability rating – HB)
Housing Material (60A):	PA66-GF13HS (U.L. 94 Flammability rating – HB)
Cover Material:	PC (U.L. 94 Flammability rating – HB)
New Weight Per Fuse:	3.8g ±10%
Insertion Force:	53N max. (12 lb.)
Extraction Force:	9N min. (2 lb.)
Complies with:	SAE 2741, ISO 8820-4



### Time-Current Characteristic Curves

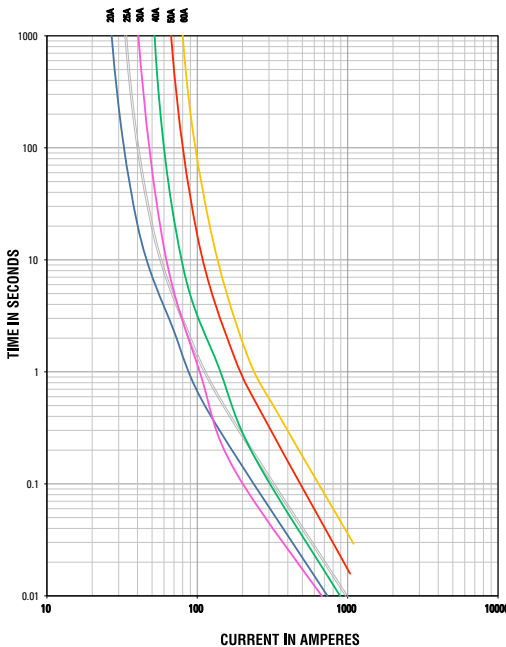

### Ordering Information

Part Number	Rating	Package Size
0495xxx.ZXA	20 - 60	2200
0495xxx.LXA	20 - 60	500
0495xxx.TXA	20 - 60	10
0495900.Z	SHUNT	2200
0495900.X	SHUNT	1

### Time-Current Characteristics

% of Rating	Opening Time Min / Max (s)
110	360,000 / ∞
135	60 / 1800
200	4 / 60
350	0.2 / 7
600	0.04 / 1

### Ratings

Part Number	Current Rating (A)	Housing Material Color	Test Cable Size (mm <sup>2</sup> )	Typ. Voltage Drop (mV)	Typ. Cold Resistance (mΩ)	Typ. I <sup>2</sup> t (A <sup>2</sup> s)
0495020_	20	Blue	4	106	4.29	1,700
0495025_	25	White	4	101	3.28	3,200
0495030_	30	Pink	4	91	2.12	1,500
0495040_	40	Green	4	87	1.30	3,700
0495050_	50	Red	6	88	0.99	8,800
0495060_	60	Yellow	6	87	0.76	19,500
0495900_	SHUNT	Black	-	-	-	-

The typical I<sup>2</sup>t is an average value calculated from the breaking capacity tests by using the melting time before the arcing occurs.

## JCASE® Cartridge Fuses Rated 32V

### Dimensions

Dimensions in mm for reference only. See outline drawing for dimensions and tolerances.

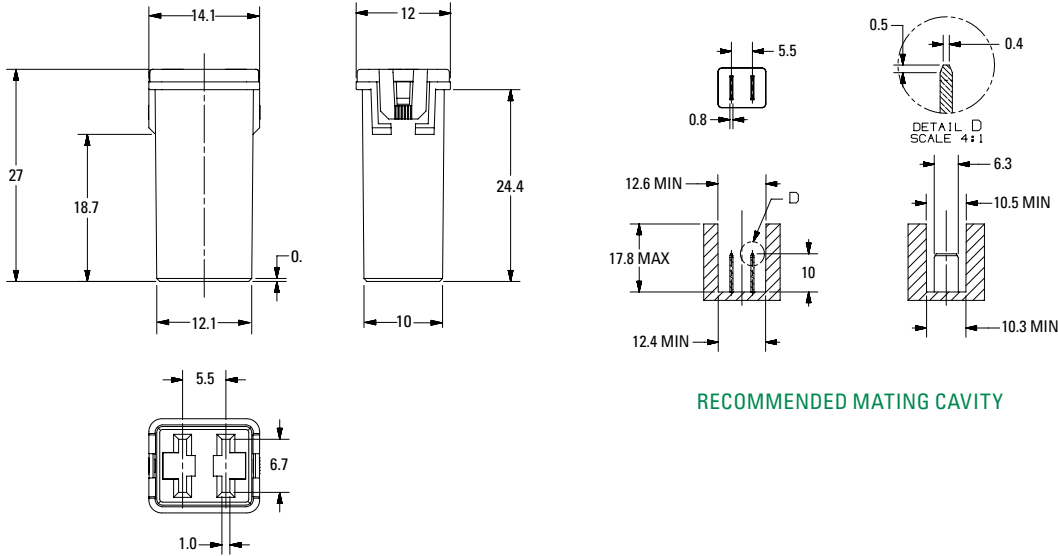

RECOMMENDED MATING CAVITY

### Typical Derating of Fuse Melting Element

Temperature Security Margin is 20%

Please contact Littelfuse® for Details Regarding Derating Test Set-Up.

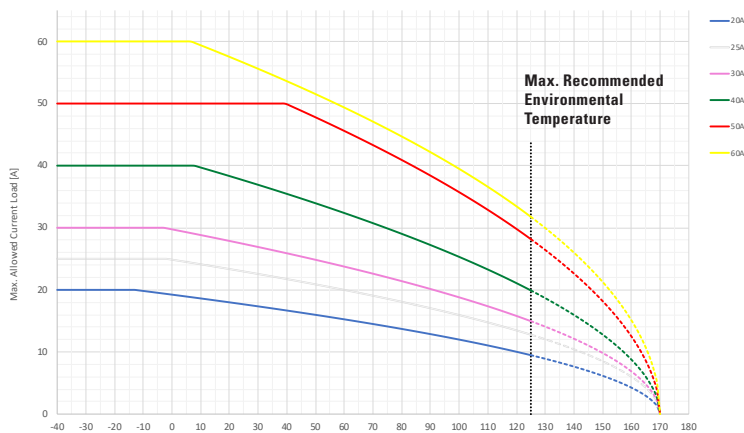

### Temperature Table

	max. allowed current load [A] at ambient temperature (typical derating)						
	-40°C	0°C	20°C	65°C	85°C	110°C	125°C
<b>20A</b>	20	20	20	17	15	12	10
<b>25A</b>	25	25	25	20	18	15	13
<b>30A</b>	30	30	30	28	25	21	18
<b>40A</b>	40	40	40	37	33	27	23
<b>50A</b>	50	50	49	40	36	29	25
<b>60A</b>	60	60	60	51	46	38	33

SHUNT Maximum Continuous Load: 50A

Derating curves may change depending on the final condition of the application (terminals characteristics, wire size etc.). Please ask Littelfuse for more information.

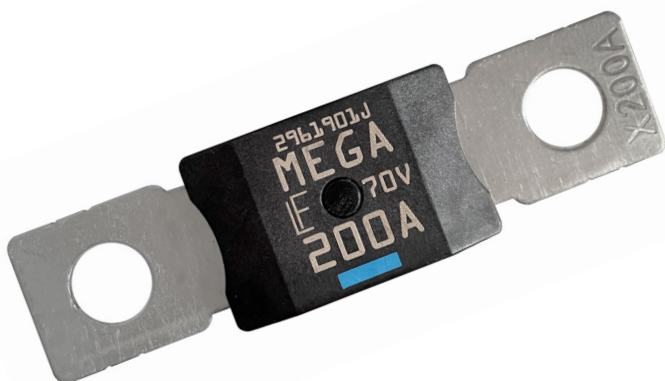

## HIGH CURRENT FUSES

ZCase Masterfuse	31
Masterfuse	32
ZCase M6/M8 Single Starter	33
ZCase M10 Bolt-Down Single Fuse Rated 32V	35
ZCase M10 Material Handling	37
MEGA+® Fuse Rated 32V	39
MEGA® High Performance Fuse Rated 70V - ISO SF51	41
MEGA® High Performance Fuse Rated 70V - ISO SF56	43
MEGA® Fuse Rated 32V	45
MEGA® Low Temperature Fuse Rated 32V	47
MEGA® Fuse Rated 120V	49
UL Recognized MEGA® Fuse Rated 32V	51
MIDI® Style Bolt-Down Fuse Rated 32V	53
MIDI® Style Bolt-Down High Performance Fuse Rated 70V	55
BF1 Fuse Rated 32V	57
BF1 Fuse Rated 58V	59
BF2 Fuse Rated 32V	61
BF2 Fuse Rated 58V	63
CF Fuse Rated 58V	65
Fuse Strips	66

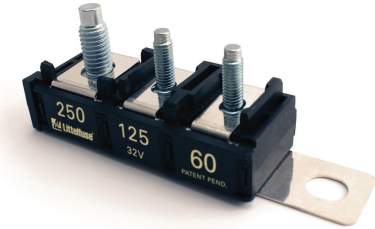
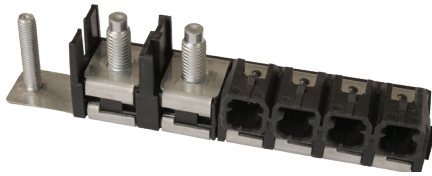

ZCASE Masterfuses

## ZCASE Masterfuse

The ZCASE Masterfuse product is the smallest high current distribution product in the industry. It utilizes the Z-Axis effectively to create a compact design which takes one third the footprint of a traditional solution. This package allows the user to replace multiple discrete fuses in a power distribution box with a single component, thus eliminating additional bolts, bus bars and interconnects. The output bolt is integrated into the fuse creating a reliable interface to the mating terminal due to its high torque withstandability. Keying features are available on each bolt position to ensure the correct mating ring terminal is used during assembly. The solution can also be connectorized to mate to high current terminals. This compact design enables the integration of the high current distribution into the main junction box due to its small footprint. This eliminates the need for a separate fuse box for high current distribution. By reducing the number of components required, overall system costs are reduced.

The ZCASE Masterfuse product is available as a standard design with customized fuse ratings. The modular manufacturing approach enables a wide range of configurations within a product family. In addition, the form factor can be fully customized for specific applications to further optimize the system. Contact Littelfuse to review your application needs.

### Features and Benefits:

**Miniaturization:** Compact design enables a 2/3 footprint reduction when compared to a traditional solution.

**Integration:** Enables the integration of the prefuse function into the main junction box due to its small footprint.

### Specifications

Mating Terminal Options:	M10, M8, M6, M5 bolt-down connections or female terminals
Operating Temperature Range:	-40°C to 125°C
Housing Material:	PPA-GF33HS
Fuse Ratings Available:	30-500A
Voltage Rating:	32Vdc
Materials:	Copper terminals (silver or tin plating options available)
Complies with:	ISO 8820-5

**RoHS**

### Ordering Information

Part Number	Description	Package Size
05980015Z-CN	MFUSE ZCASE 32V 2-Way 125A - 200A	200
05980016Z-CN	MFUSE ZCASE 32V 2-Way 125A - 125A	200
05980017Z-CN	MFUSE ZCASE 32V 2-Way 275A - 200A	200
05980019Z	MFUSE ZCASE 32V 1-MEGA + 4-MIDI	100
05980020Z	MFUSE ZCASE 32V 2-MEGA + 2-MIDI	50

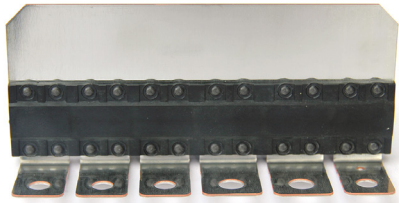

Masterfuses

## MASTERFUSE

The MASTERFUSE product is a configurable fuse solution combining several different fuse types (i.e. MEGA and MIDI) and ratings in one compact package. This fuse package allows the user to replace multiple discrete fuses in a power distribution box with a single component, thus eliminating additional bolts, bus bars, and interconnects that are currently used. By reducing the number of connections required, overall system reliability is increased while cost is decreased.

Each MASTERFUSE is customized to the user's application creating an optimized circuit protection package. Contact Littelfuse to review your application needs.

### Features and Benefits:

**Increased Reliability:**

due to reduced number of terminal interfaces

**System Cost Savings:**

Material savings due to reduced number of components required. Assembly cost savings due to reduced number of operations required for installation.

**Fuse Array Customization:** Ability to mix different fuse types (i.e. MEGA, MIDI, etc.) in one compact package

**Termination Options:**

Ability to mate to female terminals to enable "bolt-less" design

**Marking:**

Custom marking options available

### Specifications

Mating Terminal Options: M10, M8, M6, M5 bolt-down connections or female terminals

Operating Temperature Range: -40°C to 125°C

Housing Material: PPA-GF33HS

Fuse Ratings Available: 30A-250A Full Range

300A-600A Short Circuit

Voltage Rating: 32Vdc

Materials: Copper terminals (silver or tin plating options available)

Complies with: ISO 8820-5

Note: Short circuit protected fuses have a limited continuous current.

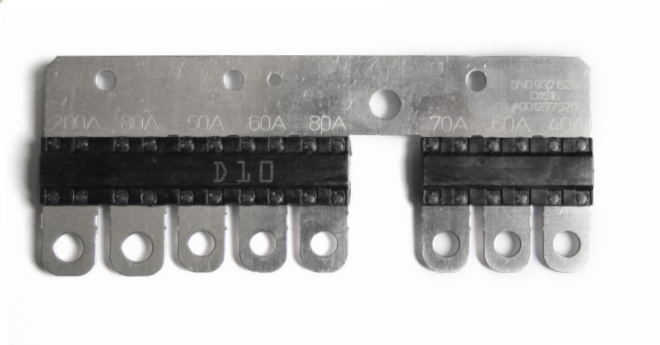



ZCASE Single Mega/Starter Fuse

## ZCASE Single MEGA/Starter Fuse

The Single ZCASE is a Minimal Footprint Bolt Down Fuse with a wide rating range up to 600A in the same packaging size. The Time Current characteristic is similar to the well known MEGA Design and can be used as full wire protection until 250A. Higher ratings mostly used for typically Starter Fuse application as a protector fuse. The fuse design is optimized for a one bolt connection M6 (40A - 250A) or M8 (300A - 600A) and can be used directly on a battery post or busbar connection. Littelfuse is offering a complete solution for the necessary stud and different busbar connections including some battery clamps.

### Specifications

Voltage Rating:	32V DC
Interrupting Rating:	2000A @ 32V VDC
Recommended Environmental Temperature:	-40 to 125°C
Terminal Material:	Tin plated Copper
Housing Material:	PPA-GF33HS (U.L. 94 Flammability rating - HB)
Insulating Tube:	Out of ceramic
Mounting Torque M6:	9.8Nm±1.4Nm
Mounting Torque M8:	14Nm±2Nm

### Time-Current Characteristic Curves

See note on next page regarding Test Set-Up

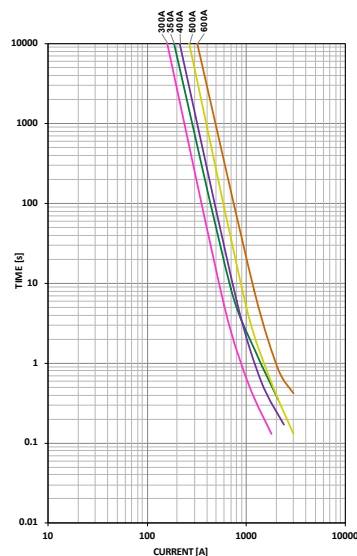
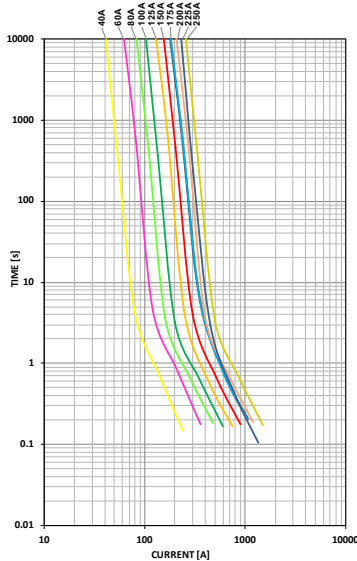

### Ordering Information

Part Number	Rating	Package Size
3298XXX.ZXSTA	300 - 600	480
3298XXX.Z	40 - 250 SHUNT	480
3298XXX.H	40 - 600	100

### Time-Current Characteristics

% of Rating	Opening Time Min / Max (s)		
	40A - 250A	300A - 500A	600A
50	- / -	14,400 / ∞	14,400 / ∞
100	14,400 / ∞	- / -	- / -
135	120 / 1800	- / -	- / -
200	1 / 15	1 / 40	1 / 40
350	0.3 / 5	0.3 / 5	0.3 / 5
500	- / -	- / -	0.1 / 1
600	0.1 / 1	0.1 / 1	- / -

### Ratings

Part number	Current Rating (A)	Test Cable Size (mm <sup>2</sup> )	Typ. Voltage Drop (mV)	Typ. Cold Resistance (mΩ)	I <sup>2</sup> t (A <sup>2</sup> s)
3298040.Z / 3298040.H	40	4	86	1.53	5,000
3298060.Z / 3298060.H	60	6	83	0.98	18,000
3298080.Z / 3298080.H	80	10	80	0.72	15,500
3298100.Z / 3298100.H	100	16	88	0.57	31,000
3298125.Z / 3298125.H	125	16	71	0.39	45,000
3298150.Z / 3298150.H	150	25	83	0.32	75,000
3298175.Z / 3298175.H	175	25	82	0.26	140,000
3298200.Z / 3298200.H	200	35	92	0.23	235,000
3298225.Z / 3298225.H	225	35	86	0.18	95,000
3298250.Z / 3298250.H	250	50	88	0.17	160,000
3298300.ZXSTA / 3298300.H	300 <sup>1</sup>	35	29 <sup>2</sup>	0.13	310,000
3298350.ZXSTA / 3298350.H	350 <sup>1</sup>	35	30 <sup>2</sup>	0.10	570,000
3298400.ZXSTA / 3298400.H	400 <sup>1</sup>	50	30 <sup>2</sup>	0.08	870,000
3298500.ZXSTA / 3298500.H	500 <sup>1</sup>	50	34 <sup>2</sup>	0.07	1,550,000
3298600.ZXSTA / 3298600.H	600 <sup>1</sup>	50	36 <sup>2</sup>	0.05	3,000,000
3298900.Z /	SHUNT	50	-	-	-

Note 1 STARTER fuses

Note 2 Voltage Drop taken at 50% of Rated Current

The typical I<sup>2</sup>t is an average value calculated from the breaking capacity tests by using the melting time before the arcing occurs.

## ZCASE Single Mega/Starter Fuse

### Dimensions

Dimensions in mm for reference only.  
See outline drawing for dimensions and tolerances.

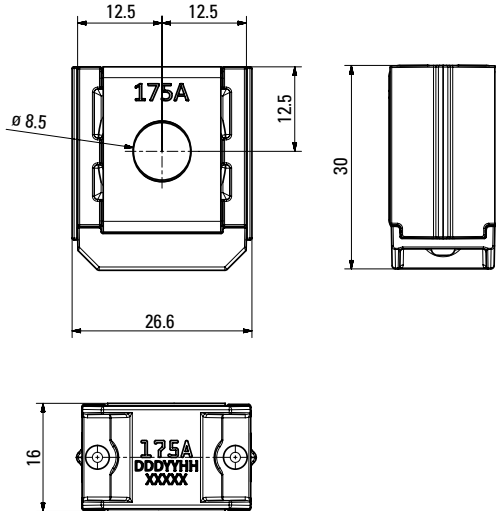

### Assembly Components (sold separately)

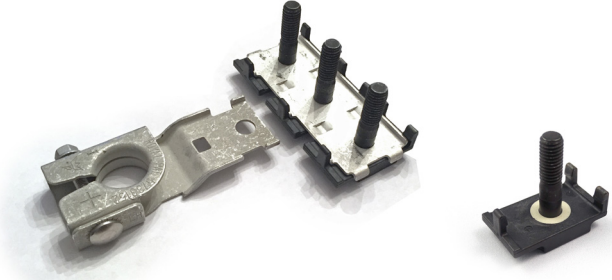

Part No.	Description
882-853	3-Way Bus Bar with M8 Insulating Bolts Assembly*
882-854	2-Way Bus Bar with M8 Insulating Bolts Assembly*
876-199	Battery Terminal Mount
32980001ZXM8	M8 Insulating Bolt

\*M8 Nuts not included

Please contact your Littelfuse representative for application support and information on mating hardware.

### Typical Derating of Fuse Melting Element

Temperature Security Margin is 20%  
Please contact Littelfuse® for Details Regarding Derating Test Set-Up.

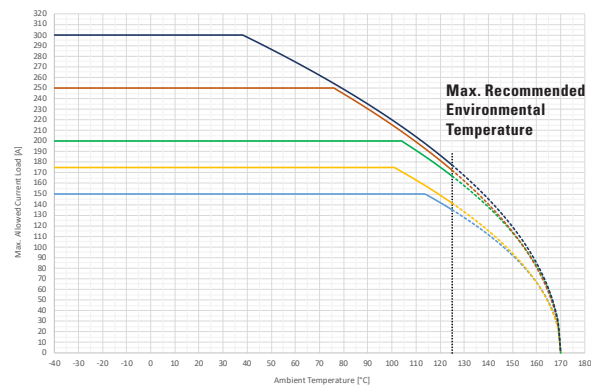
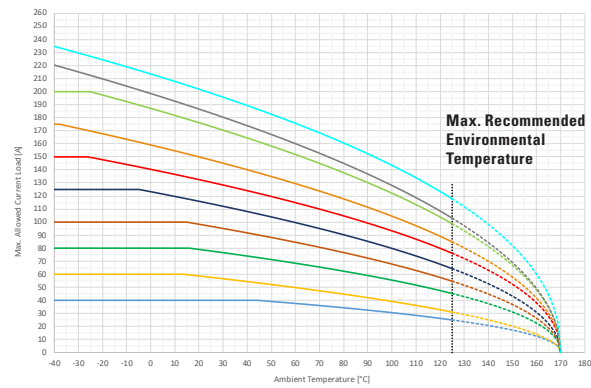

### Temperature Table

	max. allowed current load [A] at ambient temperature						
	-20°C	0°C	20°C	65°C	85°C	110°C	125°C
<b>40A</b>	40	40	40	37	33	28	25
<b>60A</b>	60	60	59	49	43	36	31
<b>80A</b>	80	80	79	67	61	52	45
<b>100A</b>	100	100	98	83	75	63	55
<b>125A</b>	125	123	116	97	88	74	64
<b>150A</b>	150	140	133	112	102	87	76
<b>175A</b>	175	159	150	127	115	97	85
<b>200A</b>	200	187	176	148	134	113	99
<b>225A</b>	220	199	187	157	141	119	103
<b>250A</b>	235	214	202	172	157	134	118
<b>300A</b>	150	150	150	150	150	150	135
<b>350A</b>	175	175	175	175	175	163	141
<b>400A</b>	200	200	200	200	200	191	167
<b>500A</b>	250	250	250	250	238	199	172
<b>600A</b>	300	300	300	268	242	204	177

All tests were performed on the left or right side of the metal bar as shown in the pictures. A 50mm<sup>2</sup> Cu wire was mounted at the mid hole (M8) as current feed.

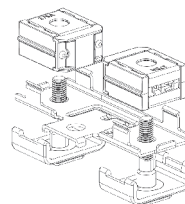

Zcase Mega Fixture

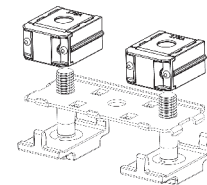

Zcase Starter Fixture

Derating curves may change depending on the final condition of the application (terminals characteristics, wire size etc.).  
Please ask Littelfuse for more information.





ZCASE M10 Bolt Down Single 32V Fuse

## ZCASE M10 Bolt Down Single 32V Fuse

The Single ZCASE is a Minimal Footprint Bolt Down Fuse with a wide rating range up to 600A in the same packaging size. The Time Current characteristic is similar to the well known MEGA Design and can be used as full wire protection until 250A. Higher ratings mostly used for typically Starter Fuse application as a protector fuse. The fuse design is optimized for a one bolt connection M10 and can be used directly on a battery post or busbar connection

### Specifications

Voltage Rating:	32 VDC
Interrupting Rating:	2000A @ 32 VDC
Recommended Environmental Temperature:	-40°C to +125°C
Housing Material:	PPA-GF33HS (U.L. 94 Flammability rating - HB)
Terminals Material:	Tin Plated Copper Alloy
Insulating Tube:	Out of Ceramic
Net Weight Per Fuse:	22±10% gr
Mounting Torque M10:	18±2 Nm



### Time-Current Characteristic Curves

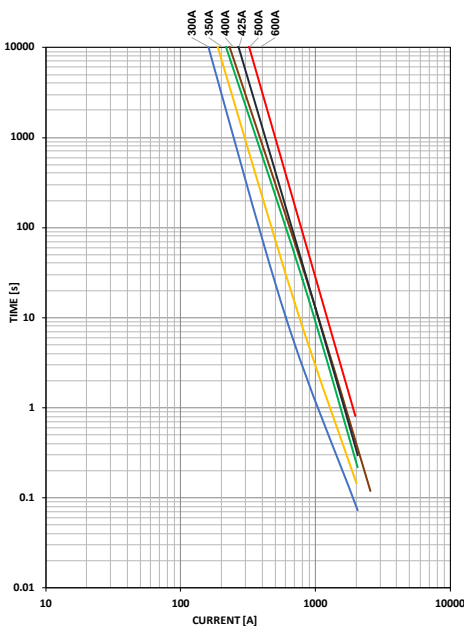
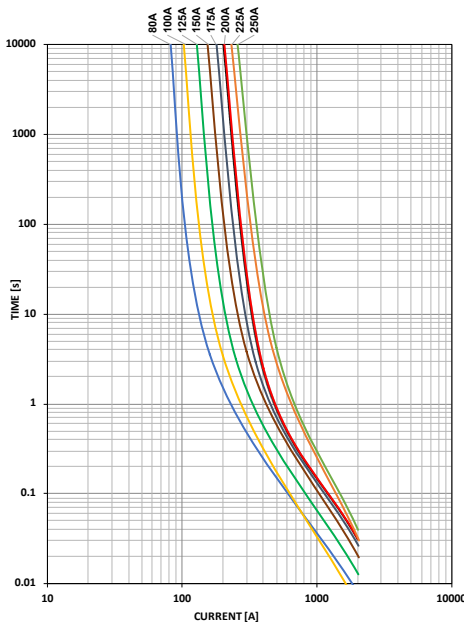

### Ordering Information

Part Number	Rating	Package Size
3298XXX.ZXM10	80 - 600 & SHUNT	480

### Time-Current Characteristics

% of Rating	Opening Time Min / Max (s)		
	40A - 250A	300A - 500A	600A
50	- / -	14,400 / ∞	14,400 / ∞
100	14,400 / ∞	- / -	- / -
135	120 / 1800	- / -	- / -
200	1 / 15	1 / 40	1 / 40
350	0.3 / 5	0.3 / 5	0.3 / 5
500	- / -	- / -	0.1 / 1
600	0.1 / 1	0.1 / 1	- / -

### Ratings

Part number	Current Rating (A)	Test Cable Size (mm <sup>2</sup> )	Typ. Voltage Drop (mV)	Typ. Cold Resistance (mΩ)	I <sup>2</sup> t (A <sup>2</sup> s)
3298080_	80	10	95	0.78	32,000
3298100_	100	16	80	0.57	23,200
3298125_	125	16	90	0.46	51,000
3298150_	150	25	78	0.34	81,600
3298175_	175	25	97	0.29	108,600
3298200_	200	35	94	0.26	126,400
3298225_	225	35	80	0.18	126,900
3298250_	250	50	82	0.17	160,900
3298300_ <sup>2</sup>	300	35	28 <sup>3</sup>	0.14	305,300
3298350_ <sup>2</sup>	350	35	29 <sup>3</sup>	0.10	583,900
3298400_ <sup>2</sup>	400	50	27 <sup>3</sup>	0.08	913,300
3298425_ <sup>1,2</sup>	425	50	27 <sup>3</sup>	0.08	602,770
3298500_ <sup>2</sup>	500	50	32 <sup>3</sup>	0.08	1,250,000
3298600_ <sup>1,2</sup>	600	50	32 <sup>3</sup>	0.05	3,140,000
3298900_ <sup>1</sup>	SHUNT	50	34	---	---

\* Note 1: Not mentioned in ISO standards  
 \* Note 2: Short Circuit Protector only  
 \* Note 3: Voltage Drop measurements for short circuit protectors taken at 50% of rated current.

The I<sup>2</sup>t value is calculated from the breaking capacity tests by using the current time profile before the arcing occurs.

## ZCASE M10 Bolt Down Single 32V Fuse

### Dimensions

Dimensions in mm for reference only. See outline drawing for dimensions and tolerances.

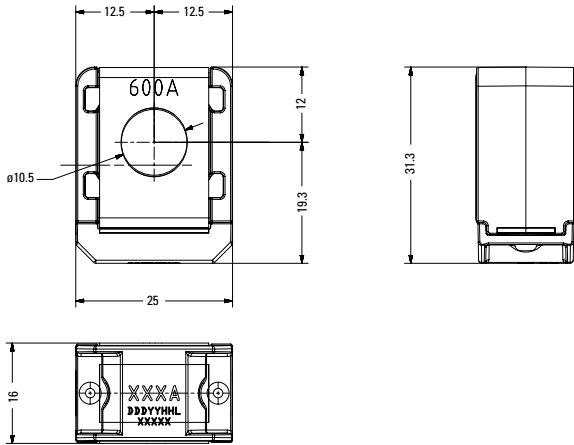

### Assembly Components (sold separately)

Part No.	Description
902-192	Insulated M10 Bolt (Required for installation/operation)

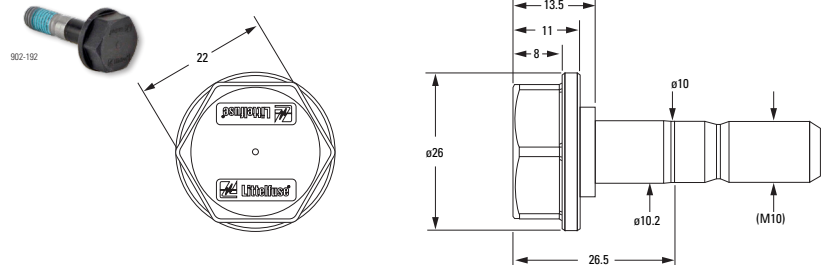

Please contact your Littelfuse representative for application support and information on mating hardware.

### Typical Derating Of Fuse Melting Element

Temperature Security Margin is 20%  
Please Contact Littelfuse® For Details Regarding Derating Test Set Up

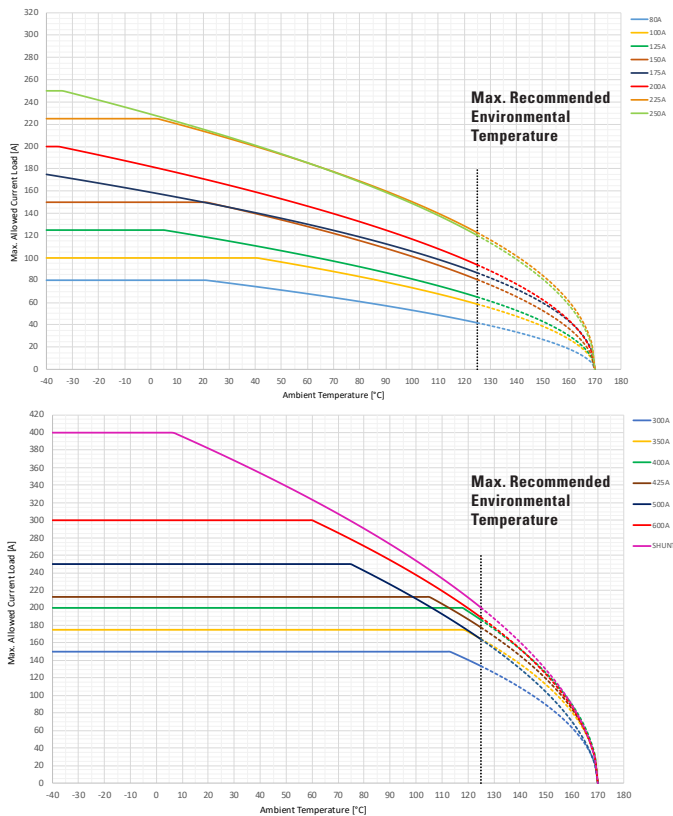

### Temperature Table

	max. allowed current load [A] at ambient temperature (typical derating)						
	-40°C	0°C	20°C	65°C	85°C	110°C	125°C
<b>80A</b>	80	80	80	66	59	49	42
<b>100A</b>	100	100	100	90	81	68	59
<b>125A</b>	125	125	119	100	89	75	65
<b>150A</b>	150	150	150	125	112	94	81
<b>175A</b>	175	159	150	128	116	99	87
<b>200A</b>	200	182	171	143	129	108	94
<b>225A</b>	225	225	214	181	165	140	123
<b>250A</b>	250	229	215	181	164	138	120
<b>300A</b>	150	150	150	150	150	150	134
<b>350A</b>	175	175	175	175	175	175	164
<b>400A</b>	200	200	200	200	200	200	186
<b>425A</b>	213	213	213	213	213	205	178
<b>500A</b>	250	250	250	250	235	193	164
<b>600A</b>	300	300	300	293	263	219	189
<b>SHUNT</b>	400	400	382	316	282	234	200

All ZCASE Derating curves were performed on the specific fixture as shown in the picture.

A 50mm<sup>2</sup> Cu wire was mounted at the opposite fuse side of the metal bar as current feed.



Derating curves may change depending on the final condition of the application (terminals characteristics, wire size exc...). Please ask Littelfuse® for more information.



ZCASE M10 Bolt Down Single Material Handling Fuse

## ZCASE M10 Bolt Down Single Material Handling Fuse

The Single ZCASE is a Minimal Footprint Bolt Down Fuse optimized for a one bolt connection M10 with a wide rating range from 70A to 600A in the same packaging size. The Time Current characteristic is similar to the well known MEGA Design and can be used as full wire protection until 250A. Higher ratings fuses are mostly used in trucks, buses, agriculture and construction equipment's or Material handling for typically Starter protector fuse.

### Specifications

Voltage Rating:	80 VDC
Interrupting Rating:	2000A @ 80 VDC
Recommended Environmental Temperature:	-40°C to +125°C
Housing Material:	PPA-GF33HS (U.L. 94 Flammability rating - HB)
Terminals Material:	Tin Plated Copper Alloy
Insulating Tube:	Out of Ceramic
Net Weight Per Fuse:	22±10% gr
Mounting Torque M10:	18±2 Nm

### RoHS

### Ordering Information

Part Number	Rating	Package Size
3998XXX.ZXM10	70 - 600 & SHUNT	480

### Time-Current Characteristics

% of Rating	Opening Time Min / Max (s)		
	40A - 250A	300A - 500A	600A
75	- / -	14,400 / ∞	14,400 / ∞
100	14,400 / ∞	- / -	- / -
135	120 / 1800	- / -	- / -
200	1 / 15	1 / 40	1 / 40
350	0.3 / 5	0.3 / 5	0.3 / 5
500	- / -	- / -	0.1 / 1
600	0.1 / 1	0.1 / 1	- / -

### Time-Current Characteristic Curves

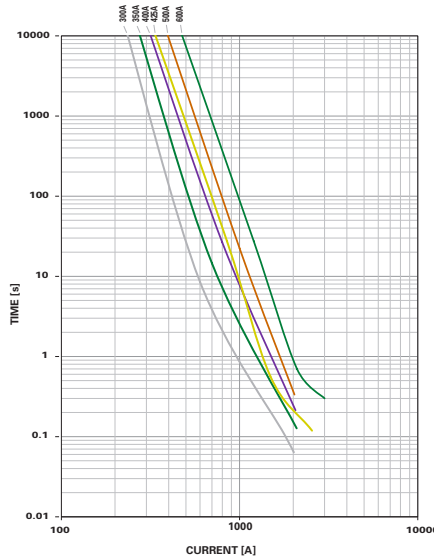
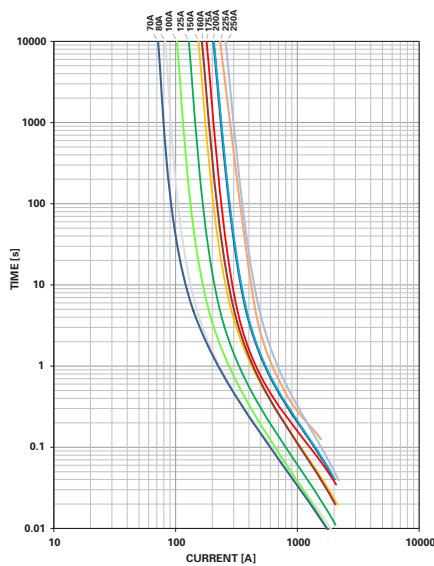

### Ratings

Part number	Current Rating (A)	Test Cable Size (mm <sup>2</sup> )	Typ. Voltage Drop (mV)	Typ. Cold Resistance (mΩ)	Typ. I <sup>2</sup> t (A <sup>2</sup> s)
3998070_	70	10	84	0.88	28,300
3998080_	80	10	95	0.78	32,000
3998100_	100	16	80	0.57	23,200
3998125_	125	16	90	0.46	52,000
3998150_	150	25	78	0.34	81,600
3998160_	160	25	82	0.34	82,800
3998175_	175	25	97	0.29	150,000
3998200_	200	35	94	0.26	165,300
3998225_	225	35	80	0.18	126,900
3998250_	250	50	82	0.17	160,900
3998300_ <sup>2</sup>	300	50	52 <sup>3</sup>	0.14	259,200
3998350_ <sup>2</sup>	350	35	29 <sup>3</sup>	0.10	583,900
3998400_ <sup>2</sup>	400	50	27 <sup>3</sup>	0.08	913,300
3998425_ <sup>1 2</sup>	425	70	30 <sup>3</sup>	0.08	690,200
3998500_ <sup>2</sup>	500	70	59 <sup>3</sup>	0.08	1,384,300
3998600_ <sup>1 2</sup>	600	70	33 <sup>3</sup>	0.05	2,771,800
3998900_ <sup>1</sup>	SHUNT	70	---	0.06	---

\* Note 1: Not mentioned in ISO standards

\* Note 2: Short Circuit Protector only

\* Note 3: Voltage Drop measurements for short circuit protectors taken at 75% of rated current.

The I<sup>2</sup>t value is calculated from the breaking capacity tests by using the current time profile before the arcing occurs.

## ZCASE M10 Bolt Down Single Material Handling

### Dimensions

Dimensions in mm for reference only.  
See outline drawing for dimensions and tolerances.

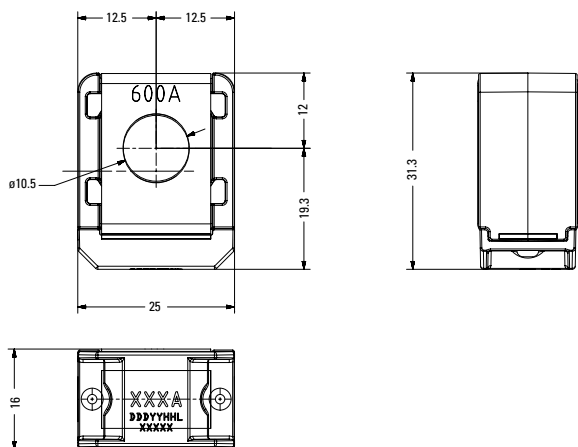

### Assembly Components (sold separately)

Part No.	Description
902-192	Insulated M10 Bolt (Required for installation/operation)

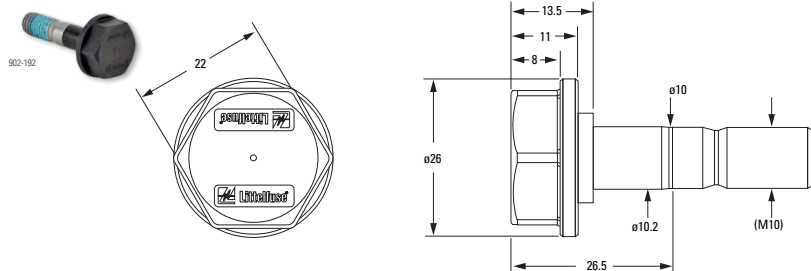

Please contact your Littelfuse representative for application support and information on mating hardware.

### Typical Derating Of Fuse Melting Element

Temperature Security Margin is 20%  
Please Contact Littelfuse® For Details Regarding Derating Test Set Up

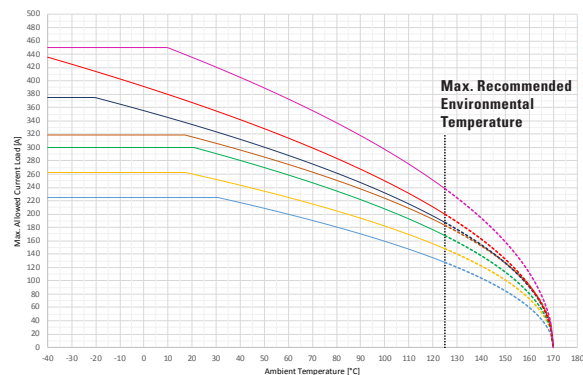
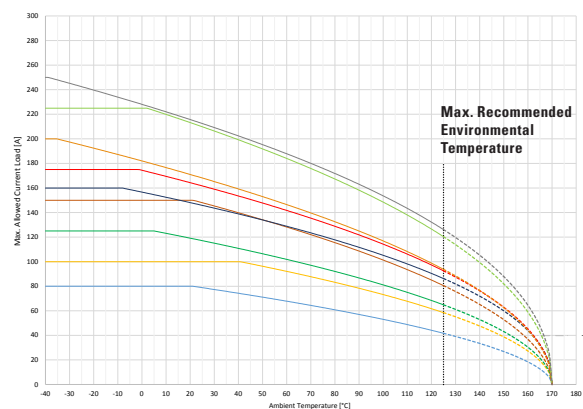

### max. allowed current load [A] at ambient temperature (typical derating)

	-40°C	0°C	20°C	65°C	85°C	110°C	125°C
<b>70A</b>	Coming Up						
<b>80A</b>	80	80	80	66	59	49	42
<b>100A</b>	100	100	100	90	81	68	59
<b>125A</b>	125	125	119	100	89	75	65
<b>150A</b>	150	150	150	125	112	94	81
<b>160A</b>	160	157	148	126	115	98	86
<b>175A</b>	175	159	150	128	116	99	87
<b>200A</b>	200	182	171	143	129	108	94
<b>225A</b>	225	225	214	181	165	140	123
<b>250A</b>	250	229	215	181	164	138	120
<b>300A</b>	225	225	225	225	225	197	170
<b>350A</b>	263	263	263	263	263	226	197
<b>400A</b>	300	300	300	300	300	257	224
<b>425A</b>	319	319	316	269	244	209	183
<b>500A</b>	375	355	334	282	255	215	188
<b>600A</b>	436	391	367	307	276	231	200
<b>SHUNT</b>	450	450	435	364	328	275	238

All ZCASE Derating curves were performed on the specific fixture as shown in the picture.

A 50 mm<sup>2</sup> Cu wire was mounted at the opposite fuse side of the metal bar as current feed. (Only for the SHUNT, a 70 mm<sup>2</sup> wire size was used as current feed).



Derating curves may change depending on the final condition of the application (terminals characteristics, wire size exc...). Please ask Littelfuse® for more information.



Bolt Down Versions



Clinch Versions  
(1 Hole and No Holes variants)

## MEGA+® Fuse Rated 32V

The MEGA+® Fuse is designed for high current circuit protection up to 500A with “Diffusion Pill Technology.” The MEGA+® Fuse also provides time delay characteristics. Designed and patented by Littelfuse, the MEGA+® Fuse is ideal for battery and alternator protection application and other heavy gauge cables requiring ultra-high current protection.

### Specifications

Voltage Rating:	32VDC
Interrupting Rating:	2000A @ 32VDC
Recommended Environmental Temperature:	-40°C to + 125°C
Terminals Material:	Tin Plated Copper Alloy
Housing Material:	PET-GF30FR (U.L. 94 Flammability rating - V-0)
Net Weight Per Fuse:	11.6±15% gr
M6 Mounting Torque:	8-14Nm - Recommended Range Value
M8 Mounting Torque:	12-18Nm - Recommended Range Value (25Nm Max Allowed) (ISO prescription 12±1Nm)
Refers to:	ISO 8820-5



### Ordering Information

### Time-Current Characteristics

Part Number	Rating	Package Size	Bolt Size	Bolt Hole Qty	% of Rating	Opening Time Min / Max (s)		
						40A-250A	300A	350A-500A
0298XXX.UXP-2M8	40 - 500	500	M8	2	75	- / -	14,400 / ∞	14,400 / ∞
0298XXX.UXP-1M8	40 - 500	500	M8	1	100	14,400 / ∞	- / -	- / -
0298XXX.UXP-2M6	40 - 500	500	M6	2	135	120 / 1800	- / -	- / -
0298XXX.UXP-1M6	40 - 500	500	M6	1	150	20 / 450	- / -	- / -
0298XXX.UXP-NH	40 - 500	500	N/A	0	200	1 / 15	1 / 15	1 / 15
					350	0.3 / 5	0.5 / 5	0.5 / 5
					500	- / -	0.1 / 2	0.1 / 2
					600	0.1 / 1	0.1 / 1	- / -

### Time-Current Characteristic Curves

TIME-CURRENT CHARACTERISTIC CURVES (RECORDED @ 23°C)

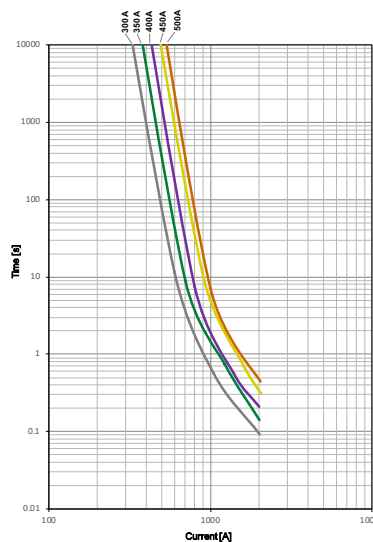
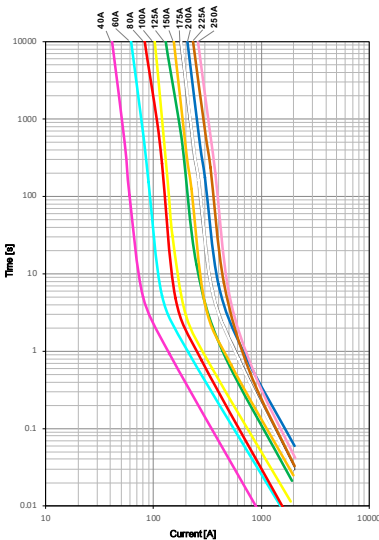

### Ratings

Part Number	Current Rating (A)	Color Code <sup>4</sup>	Test Cable size (mm <sup>2</sup> )	Typ. Voltage Drop at 100% I <sub>r</sub> (mV)	Typ. Cold Resistance (mΩ)	I <sup>2</sup> t (A <sup>2</sup> s)
0298040_1	40		4	86.9	1.52	6,600
0298060_1	60		6	88.5	0.95	22,200
0298080_	80		10	77.1	0.66	22,900
0298100_	100		16	85.9	0.55	27,600
0298125_	125		16	79.0	0.41	78,000
0298150_	150		25	90.9	0.34	97,300
0298175_	175		25	77.3	0.28	205,500
0298200_	200		35	92.8	0.26	245,800
0298225_	225		35	83.5	0.21	135,300
0298250_	250		50	85.8	0.19	176,200
0298300_2	300		70	45.3 <sup>3</sup>	0.16	378,900
0298350_2	350		70	48.2 <sup>3</sup>	0.13	573,000
0298400_2	400		70	52.0 <sup>3</sup>	0.12	844,400
0298450_2	450		70	58.3 <sup>3</sup>	0.11	1,323,600
0298500_2	500		70	57.5 <sup>3</sup>	0.09	1,850,200

Note 1: Not mentioned in ISO standards

Note 2: Short Circuit Protector only

Note 3: Voltage Drop measurements for short circuit protectors taken at 75% of rated current.

Note 4: Color Code Applicable for the UXP-2M8 and UXP-2M6 versions only - Not applicable for UXP-1M6, UXP-1M8 and UXP-NH clinch versions that have the High Contrast Mark (White Color Only)

The I<sup>2</sup>t value is calculated from the breaking capacity tests by using the current time profile before the arcing occurs.

## MEGA+® Fuses Rated 32V

### Dimensions

Dimensions in mm for reference only. See outline drawing for dimensions and tolerances

### Marking Type "A"

Color Code Rating Mark Applicable for the UXP-2M8 and UXP-2M6 versions only

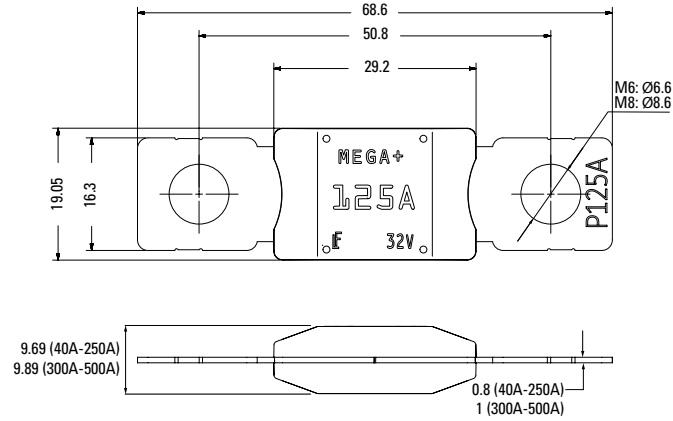

### Marking Type "B"

High Contrast Mark (White Color Only - No Color Code) applicable for UXP-1M6, UXP-1M8 and UXP-NH clinch versions

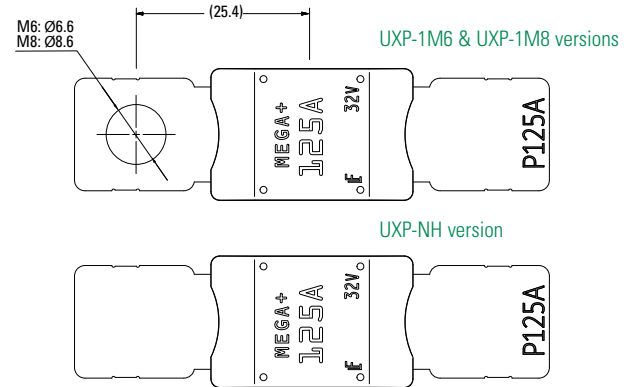

### Typical Derating Of Fuse Melting Element

Temperature Security Margin is 20%

Please Contact Littelfuse® For Details Regarding Derating Test Set Up

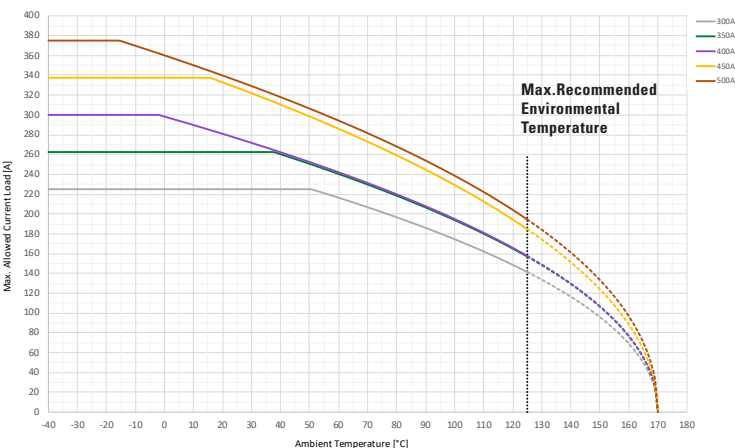
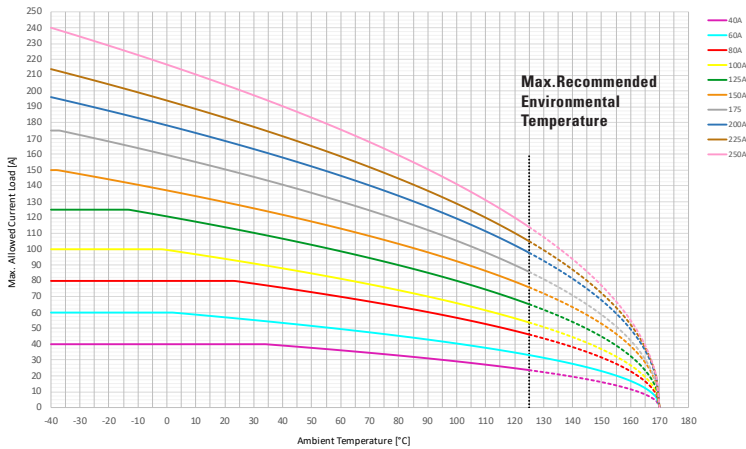

### Temperature Table

	max. allowed current load [A] at ambient temperature (typical derating)						
	-40°C	0°C	20°C	65°C	85°C	110°C	125°C
<b>40A</b>	40	40	40	35	32	27	24
<b>60A</b>	60	60	57	49	44	38	33
<b>80A</b>	80	80	80	68	62	53	46
<b>100A</b>	100	100	94	80	72	61	54
<b>125A</b>	125	121	114	97	88	75	65
<b>150A</b>	150	137	130	111	101	86	76
<b>175A</b>	175	160	151	127	115	98	86
<b>200A</b>	196	178	168	143	130	111	98
<b>225A</b>	214	194	183	155	141	120	105
<b>250A</b>	240	217	204	172	155	131	114
<b>300A</b>	225	225	225	212	191	162	141
<b>350A</b>	263	263	263	235	213	180	157
<b>400A</b>	300	298	281	237	214	181	158
<b>450A</b>	338	338	333	280	252	213	185
<b>500A</b>	375	360	340	288	261	222	194

Derating curves may change depending on the final condition of the application (terminals characteristics, wire size exc.). Please ask Littelfuse for more information.



MEGA® 70V HP Fuse-SF51

## MEGA® High Performance Fuse Rated 70V-SF51

The MEGA® 70V-SF51 High Performance (HP) Fuse is designed for high current circuit protection up to 500A with "Diffusion Pill Technology." The MEGA 70V HP features 1MΩ Open State Resistance after fuse opening to guarantee safe interruption at any voltage up to 70V. The MEGA® 70V HP Fuse is ideal for battery and alternator protection application and other heavy gauge cables requiring ultra-high current protection.

### Specifications

Voltage Rating:	70 VDC
Interrupting Rating:	2500A @ 70 VDC
Recommended Environmental Temperature:	-40°C to + 125°C
Terminals Material:	Tin Plated Copper
Housing Material:	PPA-GF33 (U.L. 94 Flammability rating – HB)
Mounting Torque M6:	9Nm+/-1Nm
Mounting Torque M8:	20Nm+/-1Nm
Open State Resistance (after fuse opening)	>1MΩ
Complies With:	ISO 20934 - Type SF51



### Time-Current Characteristic Curves

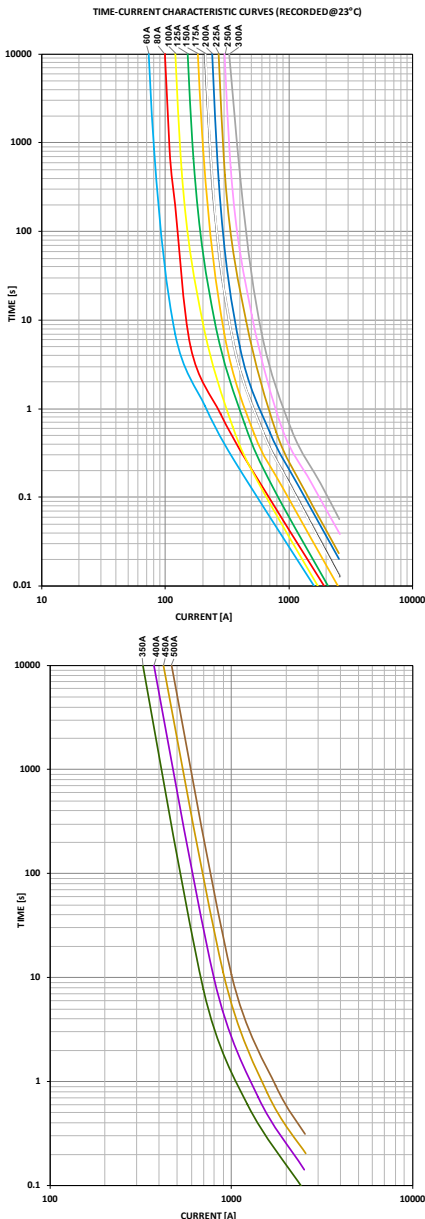















### Ordering Information

Part Number	Rating	Package Size	Bolt Size	Bolt Hole Qty
0998xxx.UX-2M8	60 - 500	500	M8	2
0998xxx.UX-1M8	60 - 500	500	M8	1
0998xxx.UX-2M6	60 - 500	500	M6	2
0998xxx.UX-1M6	60 - 500	500	M6	1
0998xxx.UX-NH	60 - 500	500	N/A	0

### Time-Current Characteristics

% of Rating	Opening Time Min / Max (s)		
	60-250A	300A	350-500A
75	-/-	14,400 / ∞	14,400 s / ∞
100	14,400 / ∞	-/-	-/-
135	120 / 1800	120 / 1800	-/-
150	20 / 450	20 / 450	-/-
200	1 / 15	1 / 15	1 / 15
350	0.3 / 5	0.3 / 5	0.5 / 5
600	0.1 / 1	0.1 / 1	0.1 / 1

### Ratings

Part Number	Current Rating (A)	Font Color	Test Cable Size (mm <sup>2</sup> )	Typ. Voltage Drop (mV)	Typ. Cold Resistance (mΩ)	I <sup>2</sup> t (A <sup>2</sup> s)
0998060_	60		6	75.5	0.90	22,800
0998080_	80		10	88.0	0.75	34,900
0998100_	100		10	66.7	0.46	24,000
0998125_	125		16	70.4	0.37	38,000
0998150_	150		25	70.6	0.32	58,100
0998175_	175		25	79.2	0.28	79,300
0998200_	200		35	76.9	0.24	123,600
0998225_	225		35	76.6	0.21	142,500
0998250_	250		50	66.0	0.17	220,000
0998300_	300		50	46.9 <sup>2</sup>	0.15	340,000
0998350_	350 <sup>1</sup>		50	50.7 <sup>2</sup>	0.14	495,000
0998400_	400 <sup>1</sup>		70	50.1 <sup>2</sup>	0.12	872,000
0998450_	450 <sup>1</sup>		70	52.9 <sup>2</sup>	0.10	1,224,000
0998500_	500 <sup>1</sup>		70	56.3 <sup>2</sup>	0.09	1,800,000

<sup>1</sup> Short Circuit Protector only

<sup>2</sup> Voltage Drop measurements for short circuit protectors taken at 75% of rated current.

The I<sup>2</sup>t value is calculated from the breaking capacity tests by using the current time profile before the arcing occurs.

## MEGA® High Performance Fuse Rated 70V-SF51

### Dimensions

Dimensions in mm for reference only.  
See outline drawing for dimensions and tolerances.

#### MEGA HP SF51 2 Holes M8/M6 versions

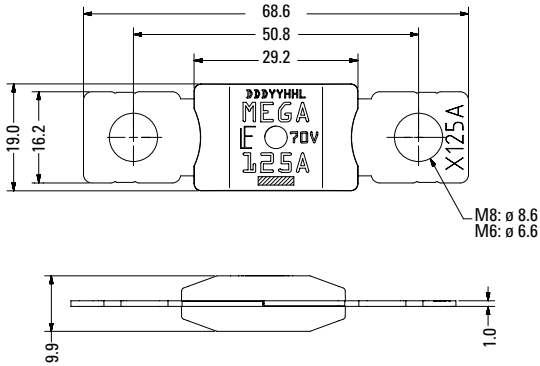

#### MEGA HP SF51 1 Hole M8/M6 versions

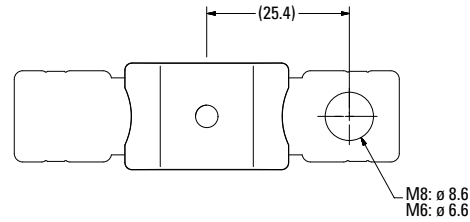

#### MEGA HP SF51 No-Holes version

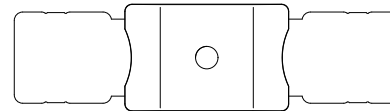

### Typical Derating Of Fuse Melting Element

Temperature Security Margin is 20%  
Please Contact Littelfuse For Details Regarding Derating Test Set Up

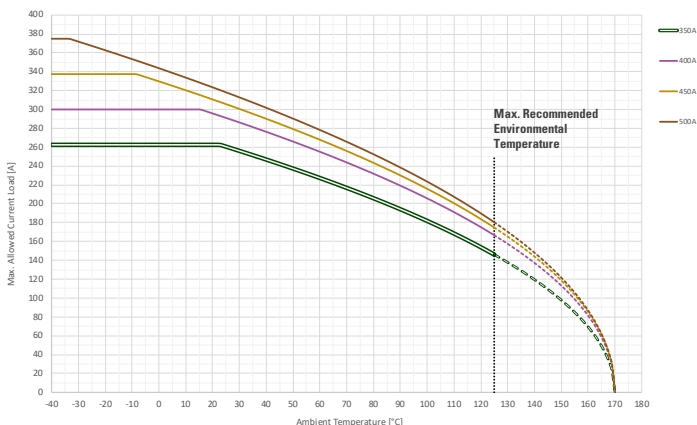
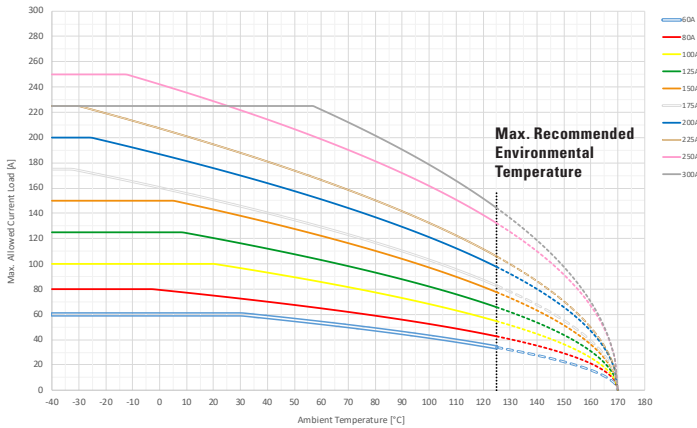

### Temperature Table

	max. allowed current load [A] at ambient temperature						
	-40°C	0°C	20°C	65°C	85°C	110°C	125°C
<b>60A</b>	60	60	60	52	47	39	34
<b>80A</b>	80	79	75	63	57	49	43
<b>100A</b>	100	100	100	84	75	63	55
<b>125A</b>	125	125	120	101	90	76	66
<b>150A</b>	150	150	143	119	107	90	78
<b>175A</b>	175	160	151	126	114	95	83
<b>200A</b>	200	187	176	148	133	112	98
<b>225A</b>	225	207	195	163	146	123	106
<b>250A</b>	250	242	229	194	177	151	132
<b>300A</b>	225	225	225	217	196	166	144
<b>350A</b>	263	263	263	222	200	168	146
<b>400A</b>	300	300	296	250	226	191	167
<b>450A</b>	338	330	311	262	237	201	175
<b>500A</b>	375	344	323	272	246	207	180

Derating curves may change depending on the final condition of the application (terminals characteristics, wire size etc.).  
Please ask Littelfuse® for more information.





MEGA® 70V HP Fuse-SF56

## MEGA® High Performance Fuse Rated 70V-SF56

The MEGA® 70V-SF56 High Performance (HP) Fuse is designed for high current circuit protection up to 500A with "Diffusion Pill Technology." The MEGA 70V HP features 1MΩm Open State Resistance after fuse opening to guarantee safe interruption at any voltage up to 70V. The MEGA® 70V HP Fuse is ideal for battery and alternator protection application and other heavy gauge cables requiring ultra-high current protection. The bigger pitch of 56mm serves as a mechanical coding feature to avoid standard SF51 fuses being mounted.

### Specifications

Voltage Rating:	70 VDC
Interrupting Rating:	2500A @ 70 VDC
Recommended Environmental Temperature:	-40°C to + 125°C
Terminals Housing:	Tin Plated ETP Copper
Housing Material:	PPA-GF33HS (UL Flammability rate - HB)
Mounting Torque M6:	9Nm+/-1Nm
Mounting Torque M8:	20Nm+/-1Nm
Open State Resistance (after fuse opening):	>1MΩm
Complies With:	ISO 20934 - Type SF56



### Time-Current Characteristic Curves

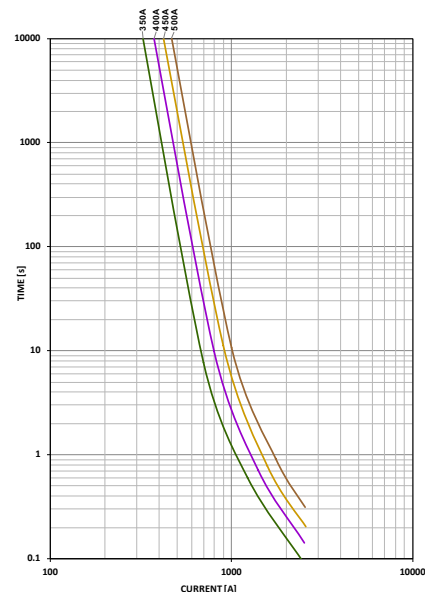
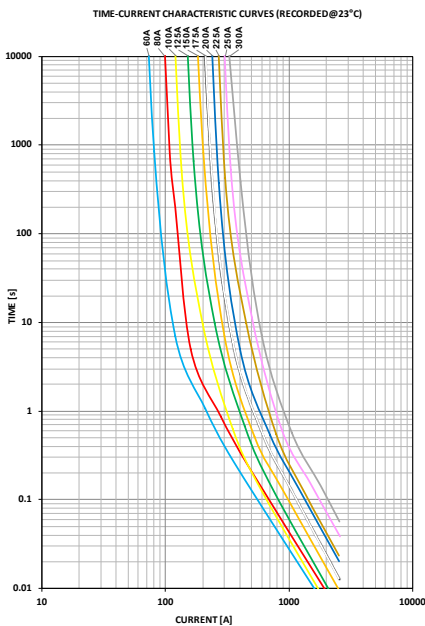

### Ordering Information

Part Number	Rating	Package Size	Bolt Size	Bolt Hole Qty
0898xxx.U-2M8	60 - 500	500	M8	2
0898xxx.U-1M8	60 - 500	500	M8	1
0898xxx.U-2M6	60 - 500	500	M6	2
0898xxx.U-1M6	60 - 500	500	M6	1
0898xxx.U-NH	60 - 500	500	N/A	0

### Time-Current Characteristics

% of Rating	Opening Time Min / Max (s)		
	60-250A	300A	350-500A
75	-/-	14,400 / ∞	14,400 s / ∞
100	14,400 / ∞	-/-	-/-
135	120 / 1800	120 / 1800	-/-
150	20 / 450	20 / 450	-/-
200	1 / 15	1 / 15	1 / 15
350	0.3 / 5	0.3 / 5	0.5 / 5
600	0.1 / 1	0.1 / 1	0.1 / 1

### Ratings

Part Number	Current Rating (A)	Color Code	Test Cable Size (mm <sup>2</sup> )	Typ. Voltage Drop (mV)	Typ. Cold Resistance (mΩ)	I <sup>2</sup> t (A <sup>2</sup> s)
0898060._	60		6	75.5	0.90	22,800
0898080._	80		10	88	0.75	34,900
0898100._	100		10	66.7	0.46	24,000
0898125._	125		16	70.4	0.37	38,000
0898150._	150		25	70.6	0.32	58,100
0898175._	175		25	79.2	0.28	79,300
0898200._	200		35	76.9	0.24	123,600
0898225._	225		35	76.6	0.21	142,500
0898250._	250		50	66	0.17	220,000
0898300._	300		50	46.9 <sup>2</sup>	0.15	340,000
0898350._	350 <sup>1</sup>		50	50.7 <sup>2</sup>	0.14	495,000
0898400._	400 <sup>1</sup>		70	50.1 <sup>2</sup>	0.12	872,000
0898450._	450 <sup>1</sup>		70	52.9 <sup>2</sup>	0.10	1,224,000
0898500._	500 <sup>1</sup>		70	56.3 <sup>2</sup>	0.09	1,800,000

<sup>1</sup> Short Circuit Protector only

<sup>2</sup> Voltage Drop measurements for short circuit protectors taken at 75% of rated current.

The I<sup>2</sup>t value is calculated from the breaking capacity tests by using the current time profile before the arcing occurs.

## MEGA® High Performance Fuse Rated 70V-SF56

### Dimensions

Dimensions in mm for reference only.  
See outline drawing for dimensions and tolerances.

#### MEGA HP SF56 2 Holes M8/M6 versions

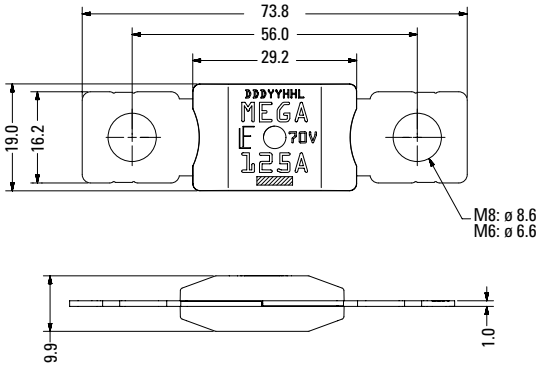

#### MEGA HP SF56 1 Hole M8/M6 versions

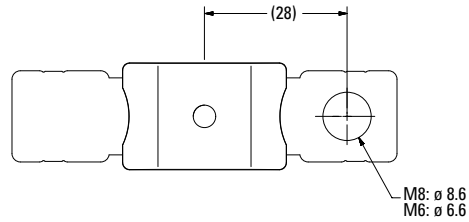

#### MEGA HP SF56 No-Holes version

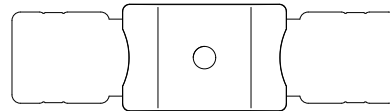

### Typical Derating Of Fuse Melting Element

Temperature Security Margin is 20%  
Please Contact Littelfuse For Details Regarding Derating Test Set Up

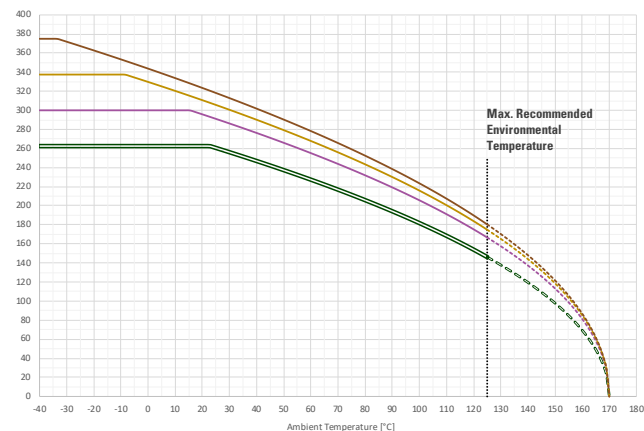
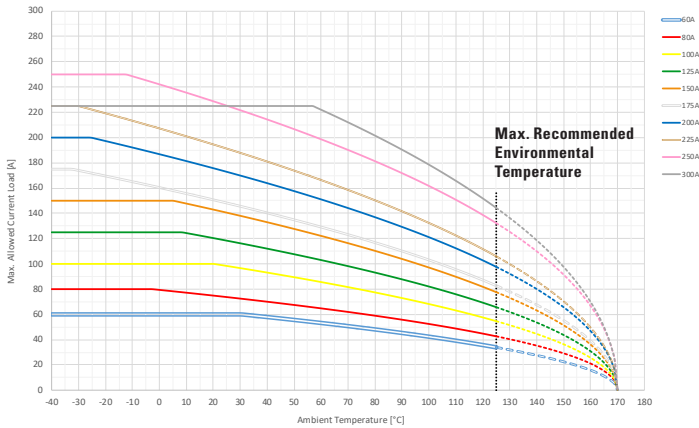

### Temperature Table

	max. allowed current load [A] at ambient temperature						
	-40°C	0°C	20°C	65°C	85°C	110°C	125°C
<b>60A</b>	60	60	60	52	47	39	34
<b>80A</b>	80	79	75	63	57	49	43
<b>100A</b>	100	100	100	84	75	63	55
<b>125A</b>	125	125	120	101	90	76	66
<b>150A</b>	150	150	143	119	107	90	78
<b>175A</b>	175	160	151	126	114	95	83
<b>200A</b>	200	187	176	148	133	112	98
<b>225A</b>	225	207	195	163	146	123	106
<b>250A</b>	250	242	229	194	177	151	132
<b>300A</b>	225	225	225	217	196	166	144
<b>350A</b>	263	263	263	222	200	168	146
<b>400A</b>	300	300	296	250	226	191	167
<b>450A</b>	338	330	311	262	237	201	175
<b>500A</b>	375	344	323	272	246	207	180

Derating curves may change depending on the final condition of the application (terminals characteristics, wire size etc.).  
Please ask Littelfuse® for more information.



MEGA® Fuses

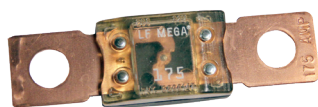

MEGA® Clear Top Housing Fuse

## MEGA® and MEGA® Clear Top Fuse Rated 32V

The MEGA® Fuse is designed for high current circuit protection up to 500A with “Diffusion Pill Technology.” The MEGA® Fuse also provides time delay characteristics. Designed and patented by Littelfuse, the MEGA® Fuse is ideal for battery and alternator protection application and other heavy gauge cables requiring ultra-high current protection.

### Specifications

Voltage Rating:	32 VDC
Interrupting Rating:	2000A @ 32 VDC
Recommended Environmental Temperature:	-40°C to + 125°C
Terminals Materials:	Copper (Silver plated copper available)
Housing Material:	PPA-GF33HS (U.L. 94 Flammability rating - HB)
Clear Top Housing Material:	PES (top) (U.L. 94 Flammability rating - V0) PPA-GF33HS (bottom) (U.L. 94 Flammability rating - HB)
Mounting Torque M6:	8-14 Nm
Mounting Torque M8:	12-18 Nm
Complies with:	ISO 8820-5



### Time-Current Characteristic Curves

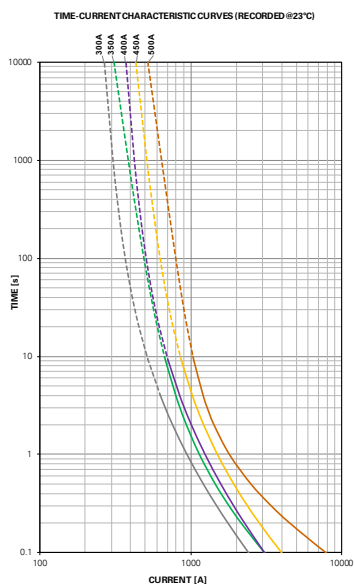
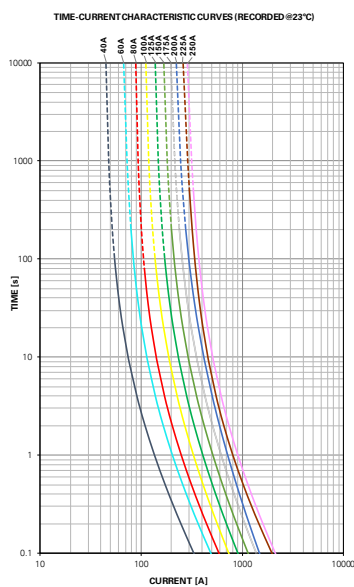

### Ordering Information

Part Number	Rating	Package Size	Plating	Bolt Size	Bolt Hole Qty
0298xxx.ZXEH	80 - 250	500	None	M8	2
0298xxx.ZXH	300 - 500	500	None	M8	2
0298xxx.UX1M8	80 - 500	500	None	M8	1
0298xxx.ZXB	40 - 250	500	Ag	M8	2
0298xxx.ZXA	80 - 500	500	None	M6	2
0298xxx.UXT	40 - 250	500	None	M8	2

### MEGA Clear Top Housing Material Fuse

0298xxx.UXT	40 - 250	500	None	M8	2
-------------	----------	-----	------	----	---

### Time-Current Characteristics

% of Rating	Opening Time Min / Max (s)	
	40-250	300-500
75	- / -	14,400 / ∞
100	14,400 / ∞	- / -
135	120 / 1800	- / -
200	1 / 15	1 / 15
350	0.3 / 5	0.5 / 5
600	0.1 / 1	0.1 / 1

### Ratings

Part Number	Current Rating (A)	Color Code <sup>3</sup>	Test Cable Size (mm <sup>2</sup> )	Typ. Voltage Drop (mV)	Typ. Cold Resistance (mΩ)	Typ. I <sup>2</sup> t (A <sup>2</sup> s)
0298040_1	40	-	4	132	2.51	8,700
0298060_1	60	-	6	119	1.50	21,000
0298080_	80	Red	10	87	0.72	21,500
0298100_	100	Yellow	16	87	0.56	31,100
0298125_	125	Green	16	80	0.42	57,800
0298150_	150	Orange	25	92	0.35	100,000
0298175_	175	White	25	86	0.29	168,000
0298200_	200	Blue	35	83	0.26	204,000
0298225_	225	Brown	35	82	0.22	257,000
0298250_	250	Pink	50	82	0.20	389,000
0298300_2	300	Grey	70	74 <sup>4</sup>	0.17	315,000
0298350_2	350	Dark Green	70	68 <sup>4</sup>	0.14	500,000
0298400_2	400	Purple	70	64 <sup>4</sup>	0.13	610,000
0298450_2	450	Yellow-Green	70	60 <sup>4</sup>	0.11	1,050,000
0298500_2	500	Brown	70	58 <sup>4</sup>	0.09	2,050,000

1: Not mentioned in ISO standards, 2: Short Circuit Protector only, 3: 0298xxx.ZXB has white font color on all ratings. 4: Voltage Drop measurements for short circuit protectors taken at 75% of rated current.

The typical I<sup>2</sup>t is an average value calculated from the breaking capacity tests by using the melting time before the arcing occurs.

## MEGA® Fuse Rated 32V

### Dimensions

Dimensions in mm for reference only.  
See outline drawing for dimensions and tolerances.

#### ZX & UXT Versions

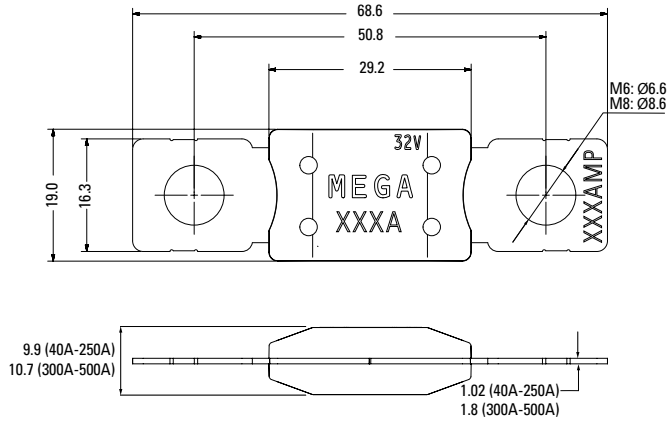

#### UX1M8 Version

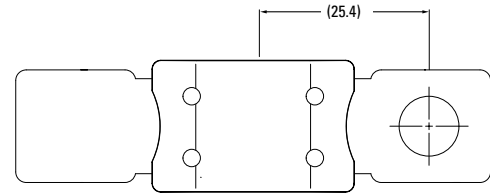

### Typical Derating

Temperature Security Margin is 20%  
Please contact Littelfuse® for Details Regarding Derating Test Set-Up.

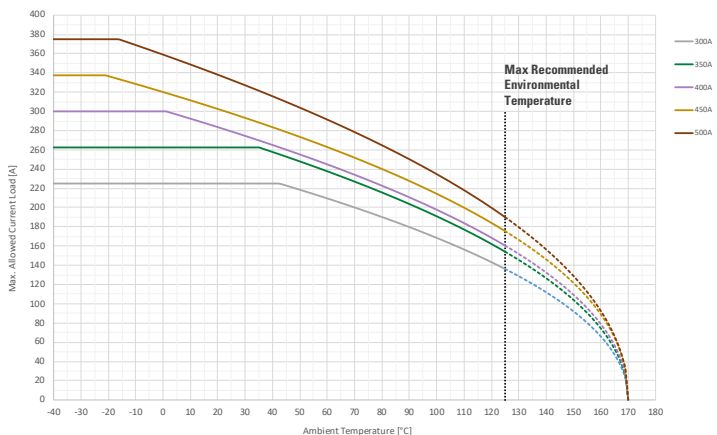
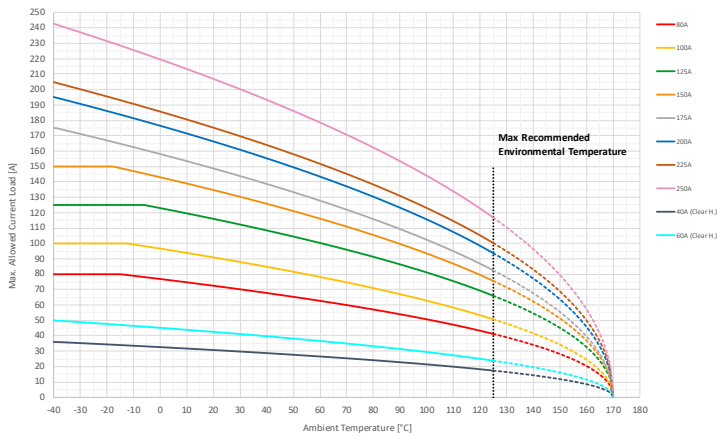

### Temperature Table

max. allowed current load [A] at ambient temperature							
	-40°C	0°C	20°C	65°C	85°C	110°C	125°C
<b>40A</b>	36	33	31	26	23	20	17
<b>60A</b>	50	45	43	36	32	27	24
<b>80A</b>	80	77	73	61	56	47	41
<b>100A</b>	100	97	91	76	69	58	51
<b>125A</b>	125	123	116	98	89	76	66
<b>150A</b>	150	143	135	114	103	87	76
<b>175A</b>	175	158	149	125	113	95	83
<b>200A</b>	195	176	166	140	127	107	94
<b>225A</b>	205	186	175	148	135	115	100
<b>250A</b>	243	220	207	175	158	134	117
<b>300A</b>	225	225	225	205	185	156	136
<b>350A</b>	263	263	263	232	210	177	154
<b>400A</b>	300	300	284	240	217	184	160
<b>450A</b>	338	320	302	257	234	200	176
<b>500A</b>	375	359	338	285	258	218	190

Derating curves may change depending on the final condition of the application (terminals characteristics, wire size etc.).  
Please ask Littelfuse for more information.

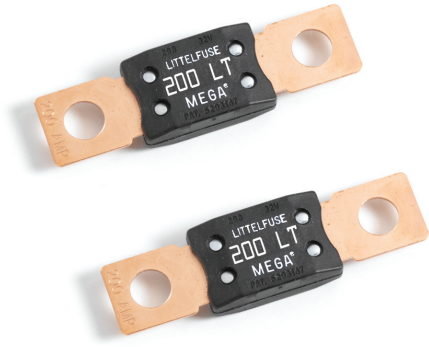

MEGA® Low Temperature Fuses

## MEGA® Low Temperature Fuse Rated 32V

The MEGA® Fuse is designed for high current circuit protection up to 275A with “Diffusion Pill Technology.” The MEGA® Fuse also provides time delay characteristics. Designed and patented by Littelfuse, the MEGA® Fuse is ideal for battery and alternator protection application and other heavy gauge cables requiring ultra-high current protection.

### Specifications

Voltage Rating:	32 VDC
Interrupting Rating:	2000A @ 32 VDC
Recommended Environmental Temperature:	-40°C to + 125°C
Terminals Materials:	Copper (Silver plated copper available)
Housing Material:	PPA-GF33HS (U.L. 94 Flammability rating - HB)
Mounting Torque M8:	12-18 Nm

**RoHS**

### Time-Current Characteristic Curves

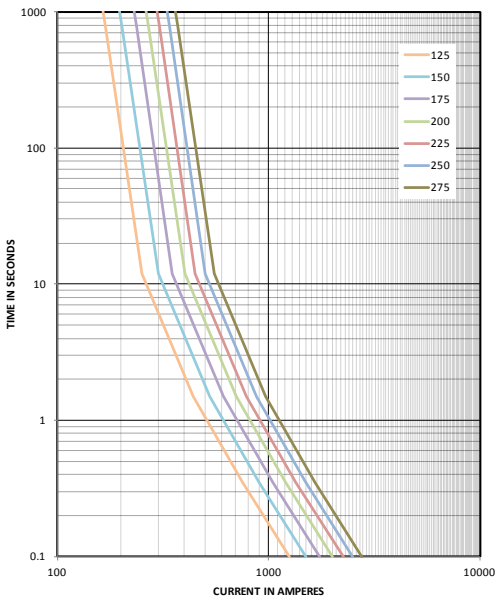

### Ordering Information

Part Number	Rating	Package Size	Plating	Bolt Hole Qty
0298125.ZXBLT	125	500	Ag	2
0298xxx.ZXEH-LT	150-275	500	None	2
0298xxx.UX1M8LT	150-275	500	None	1

### Time-Current Characteristics

% of Rating	Opening Time Min / Max (s)	
	125	150-275
100	14,400 / ∞	14,400 / ∞
135	120 / 1800	120 / 1800
200	1 / 50	1 / 150
350	0.3 / 5	0.3 / 5
600	0.1 / 1	0.1 / 1

### Ratings

Part Number	Current Rating (A)	Font Color	Test Cable Size (mm <sup>2</sup> )	Typ. Voltage Drop (mV)	Typ. Cold Resistance (mΩ)	Typ. I <sup>2</sup> t (A <sup>2</sup> s)
0298125.ZXBLT	125	□	16	67	0.33	57,000
0298150.ZXEH-LT	150	□	25	62	0.26	59,000
0298175.ZXEH-LT	175	□	25	65	0.23	123,000
0298200.ZXEH-LT	200	□	35	61	0.21	140,000
0298225.ZXEH-LT	225	□	35	57	0.18	317,000
0298250.ZXEH-LT	250	□	50	54	0.14	637,000
0298275.ZXEH-LT	275	□	50	53	0.12	800,000

The typical I<sup>2</sup>t is an average value calculated from the breaking capacity tests by using the melting time before the arcing occurs.

## MEGA® Low Temperature Fuse Rated 32V

### Dimensions

Dimensions in mm for reference only.  
See outline drawing for dimensions and tolerances.

#### ZXBLT & ZXEH-LT Versions

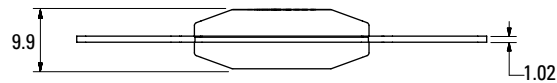
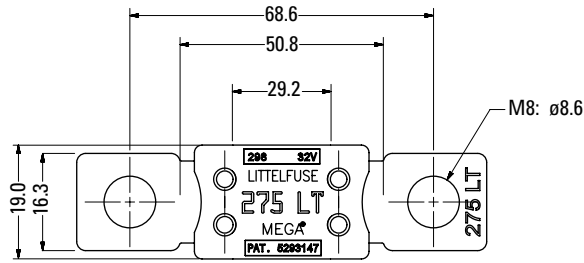

#### UX1M8LT Version

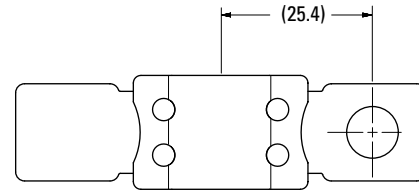

### Typical Derating of Fuse Melting Element

Temperature Security Margin is 20%  
Please contact Littelfuse® for Details Regarding Derating Test Set-Up.

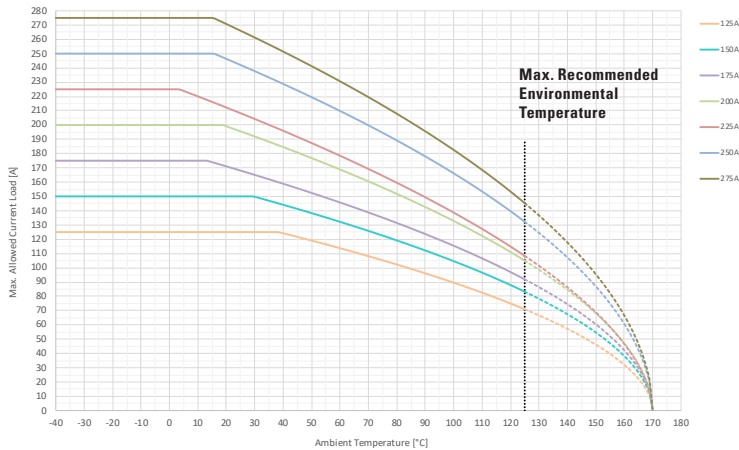

Derating curves may change depending on the final condition of the application (terminals characteristics, wire size etc.).  
Please ask Littelfuse® for more information.

### Temperature Table

	max. allowed current load [A] at ambient temperature (typical derating)						
	-40°C	0°C	20°C	65°C	85°C	110°C	125°C
<b>125A</b>	125	125	125	111	99	83	71
<b>150A</b>	150	150	150	129	116	97	83
<b>175A</b>	175	175	171	142	128	107	92
<b>200A</b>	200	200	199	165	147	122	105
<b>225A</b>	225	225	212	174	155	127	108
<b>250A</b>	250	250	246	205	184	153	132
<b>275A</b>	275	275	271	225	202	169	145



MEGA® 120V HP Fuse-SF56

## MEGA® High Performance Fuse Rated 120V-SF56

The MEGA® 120V-SF56 High Performance (HP) Fuse is designed for high current circuit protection up to 650A with "Diffusion Pill Technology." The MEGA® 120V HP Fuse is ideal for battery and alternator protection application and other heavy gauge cables requiring ultra-high current protection. The bigger pitch of 56mm serves as a mechanical coding feature to avoid standard SF51 fuses being mounted.

### Specifications

Voltage Rating:	120 VDC
Interrupting Rating:	2500A @ 120 VDC
Recommended Environmental Temperature:	-40°C to + 125°C
Terminals Material:	Tin Plated Copper Alloy
Housing Material:	PPA-GF33 (U.L. 94 Flammability rating - HB)
Net Weight Per Fuse:	12.1±15% gr
Mounting Torque M6:	9Nm+/-1Nm
Mounting Torque M8:	20Nm+/-1Nm
Refers to:	ISO 20934 – Type SF56



### Time-Current Characteristic Curves

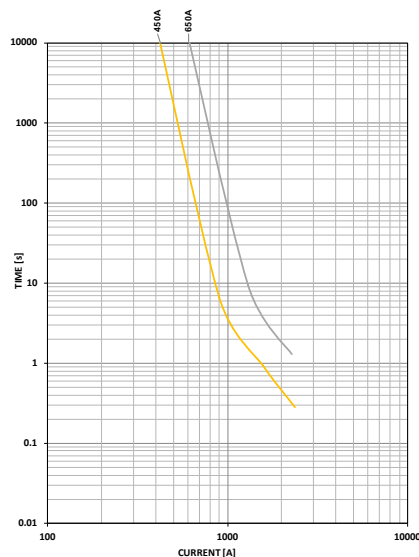
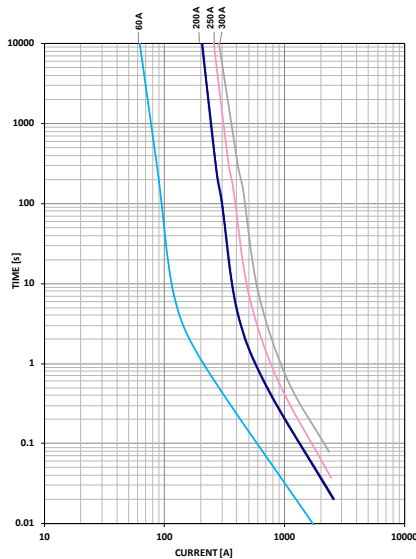

### Ordering Information







Part Number	Rating	Package Size	Bolt Size	Bolt Hole Qty
0888xxx.U-2M8	60 - 500	500	M8	2
0888xxx.U-1M8	60 - 500	500	M8	1
0888xxx.U-2M6	60 - 500	500	M6	2
0888xxx.U-1M6	60 - 500	500	M6	1
0888xxx.U-NH	60 - 500	500	N/A	0

### Time-Current Characteristics

% of Rating	Opening Time Min / Max (s)		
	60A - 250A	300A	450A - 650A
75	-/-	14,400 / ∞	14,400 / ∞
100	14,400 / ∞	-/-	-/-
135	120 / 1800	120 / 1800	-/-
150	20 / 450	20 / 450	-/-
200	1 / 15	1 / 15	1 / 15
350	0.3 / 5	0.3 / 5	0.5 / 5
600*	0.1 / 1	0.1 / 1	0.1 / 1

\* Not applicable for 650A.

### Ratings

Part Number	Current Rating (A)	Color Code	Test Cable Size (mm <sup>2</sup> )	Typ. Voltage Drop (mV)	Typ. Cold Resistance (mΩ)	I <sup>2</sup> t (A <sup>2</sup> s)
0888060._	60		6	75.5	0.92	27,800
0888200._	200		35	76.9	0.25	129,600
0888250._	250		50	66	0.18	223,200
0888300._	300		50	46.9 <sup>2</sup>	0.15	434,000
0888450._	450 <sup>1</sup>		70	52.9 <sup>2</sup>	0.10	1,579,000
0888650._	650 <sup>1</sup>		95	53.7 <sup>2</sup>	0.07	5,262,500

Note 1: Short Circuit Protector only

Note 2: Voltage Drop measurements taken at 75% of rated current.

The I<sup>2</sup>t value is calculated from the breaking capacity tests by using the current time profile before the arcing occurs.

## MEGA® High Performance Fuse Rated 120V-SF56

### Dimensions

Dimensions in mm for reference only. See outline drawing for dimensions and tolerances.

#### MEGA 2 Holes M8/M6

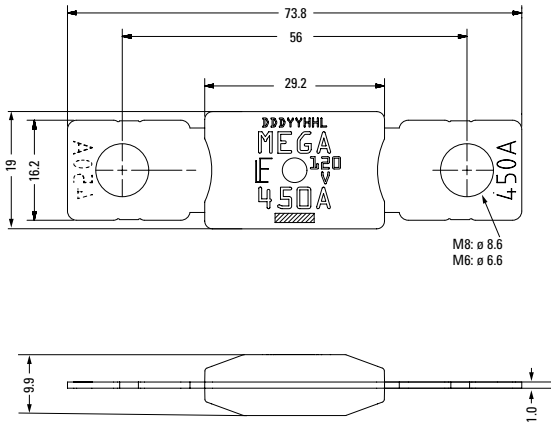

#### MEGA 1 Hole M8/M6

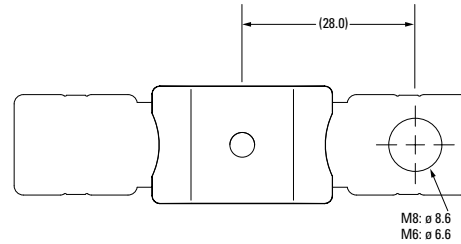

#### MEGA No-Holes Version

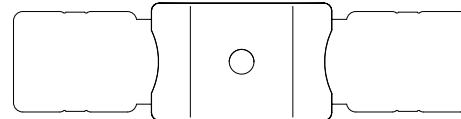

### Typical Derating of Fuse Melting Element

Temperature Security Margin is 20%

Please Contact Littelfuse® For Details Regarding Derating Test Set Up.

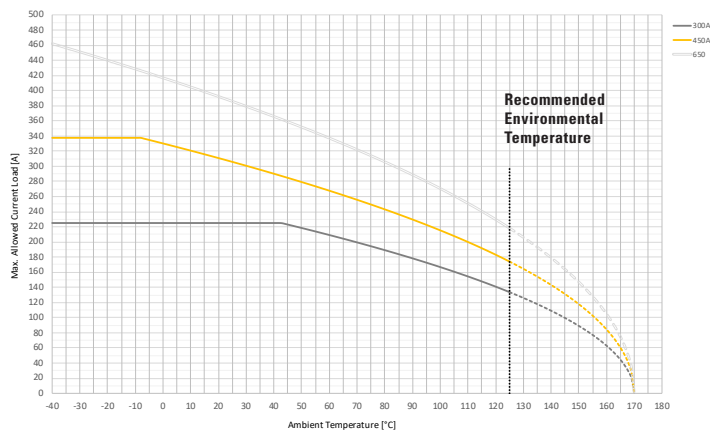
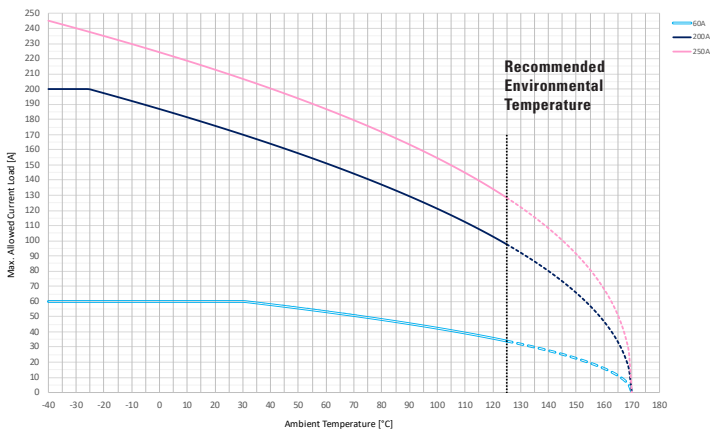

### Temperature Table

	max. allowed current load [A] at ambient temperature (typical derating)						
	-40°C	0°C	20°C	65°C	85°C	110°C	125°C
<b>60A</b>	60	60	60	52	47	39	34
<b>200A</b>	200	187	176	148	133	112	98
<b>250A</b>	245	224	213	183	168	145	128
<b>300A</b>	225	225	225	204	184	154	134
<b>450A</b>	338	330	311	262	236	200	174
<b>650A</b>	462	417	392	330	297	251	218

Derating curves may change depending on the final condition of the application (terminals characteristics, wire size etc...). Please ask Littelfuse for more information.



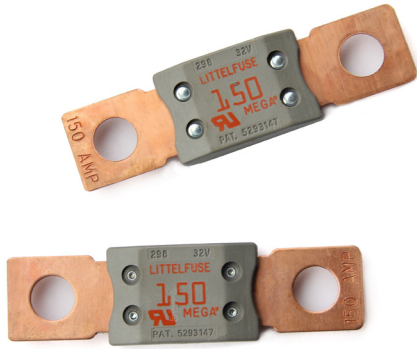

UL Recognized MEGA® Fuses

## UL Recognized MEGA® Fuses Rated 32V

The MEGA® Fuse is designed for high current circuit protection with “Diffusion Pill Technology.” The MEGA® Fuse also provides time delay characteristics. Designed and patented by Littelfuse, the MEGA® Fuse is ideal for battery and alternator protection application and other heavy gauge cables requiring ultra-high current protection.

### Specifications

Voltage Rating:	32 VDC
Interrupting Rating:	2000A @ 32 VDC
Recommended Environmental Temperature:	-40°C to + 125°C
Terminals Material:	Copper
Housing Material:	PPA-GF30FR (U.L. 94 Flammability rating - V0)
Mounting Torque M8:	12-18 Nm
Complies with:	ISO 8820-5 ,UL 248 Special Purpose Fuses



### Time-Current Characteristic Curves

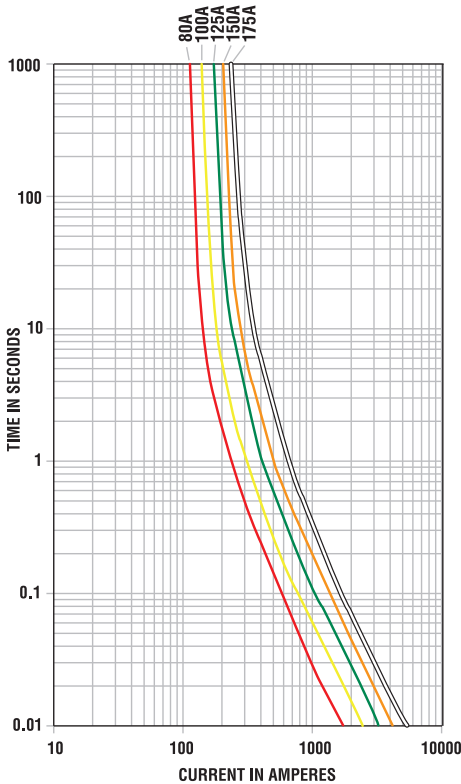

### Ordering Information

Part Number	Rating	Package Size	Bolt Size
0298xxx.ZXEH-UL	80 - 175	500	M8

### Time-Current Characteristics

% of Rating	Opening Time Min / Max (s)
	80A-175A
75	- / -
100	14,400 / ∞
135	120 / 1800
200	1 / 15
350	0.3 / 5
500	- / -
600	0.1 / 1

### Ratings

Part Number	Current Rating (A)	Color Code	Test Cable Size (mm <sup>2</sup> )	Typ. Voltage Drop (mV)	Typ. Cold Resistance (mΩ)	Typ. I <sup>2</sup> t (A <sup>2</sup> s)
0298080.ZXEH-UL	80	Red	10	87	0.72	21,500
0298100.ZXEH-UL	100	Yellow	16	87	0.56	31,100
0298125.ZXEH-UL	125	Green	16	80	0.42	57,800
0298150.ZXEH-UL	150	Orange	25	92	0.35	100,000
0298175.ZXEH-UL	175	White	25	62	0.23	168,000

The typical I<sup>2</sup>t is an average value calculated from the breaking capacity tests by using the melting time before the arcing occurs.

## UL Recognized MEGA® Fuses Rated 32V

### Dimensions

Dimensions in mm for reference only.  
See outline drawing for dimensions and tolerances.

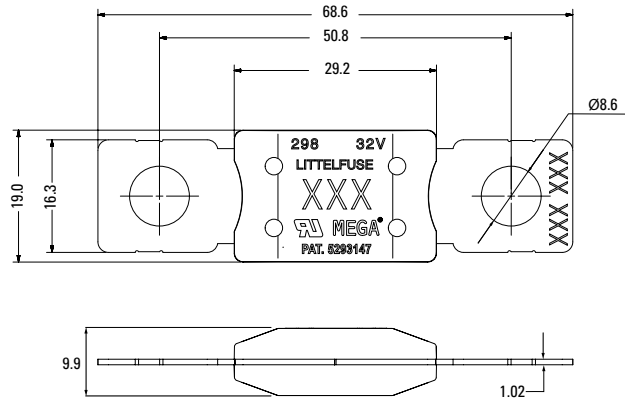

### Temperature Table

	max. allowed current load [A] at ambient temperature (typical derating)						
	-40°C	0°C	20°C	65°C	85°C	110°C	125°C
<b>80A</b>	80	77	73	61	56	47	41
<b>100A</b>	100	97	91	76	69	58	51
<b>125A</b>	125	123	116	98	89	76	66
<b>150A</b>	150	143	135	114	103	87	76
<b>175A</b>	175	175	171	142	128	107	92

### Typical Derating of Fuse Melting Element

Temperature Security Margin is 20%

Please contact Littelfuse® for Details Regarding Derating Test Set-Up.

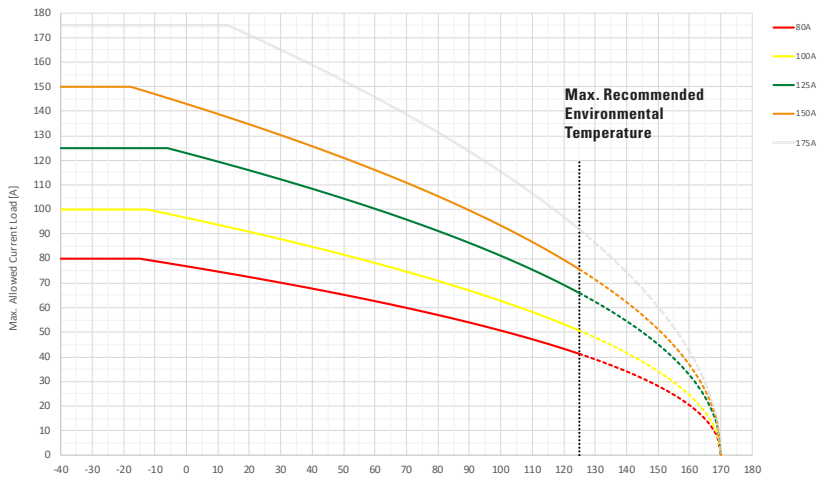

Derating curves may change depending on the final condition of the application (terminals characteristics, wire size etc.).  
Please ask Littelfuse® for more information.

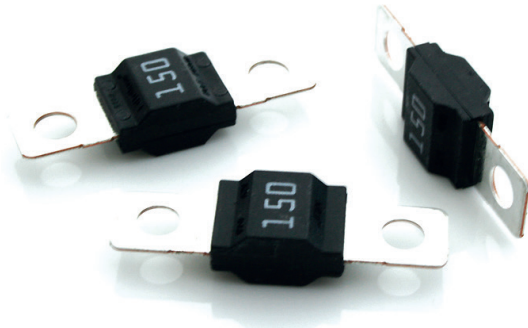

MIDI® Fuses

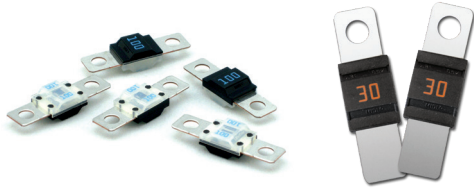

Clear MIDI® Fuses  
(clear nylon composite cover)

One Hole MIDI® Fuses

## MIDI®, Clear MIDI®, and One Hole MIDI® Style Bolt-down Fuse Rated 32V

This MIDI® style fuse offers a bolt-on space saving fuse for high current wiring protection and provides time delay characteristics with “Diffusion Pill Technology”.

### Specifications

Voltage Rating:	32 VDC
Interrupting Rating:	2000A @ 32 VDC
Recommended Environmental Temperature:	-40°C to + 125°C
Terminals Material:	Tin plated Copper
Black Housing Material:	PA66-GF25 (U.L. 94 Flammability rating – V0)
Clear Housing Material:	PA6/66 (U.L. 94 Flammability rating – HB)
Mounting Torque M5:	4.5 Nm +/- 1Nm
Mounting Torque M6:	6.0 Nm +/- 1Nm
Refers to:	ISO 8820-5:2015
Complies with:	Standard UL 248-1 as a Special Purpose Fuses in UL file E71611 (40-100A) and Directive 2011/65/EU



### Ordering Information

Part Number	Rating	Package Size	Housing Color	Bolt Size	Bolt Hole Qty	Mfg Location
0498xxx.M	30 - 200	1000	Black	M5	2	Mexico
0498xxx.M-CN	30 - 200	1000	Black	M5	2	China
0498xxx.H	30 - 200	100	Black	M5	2	Mexico
0498xxx.MXM6	30 - 200	1000	Black	M6	2	Mexico
0498xxx.MXM6-CN	30 - 200	1000	Black	M6	2	China
0498xxx.MX1M5	30 - 200	1000	Black	M5	1	Mexico
0498xxx.MX1M5-CN	30 - 200	1000	Black	M5	1	China
0498xxx.MX1M6	30 - 200	1000	Black	M6	1	Mexico
0498xxx.MX1M6-CN	30 - 200	1000	Black	M6	1	China
0498xxx.MXT	30 - 200	1000	Clear	M5	2	Mexico
0498xxx.MXT-CN	30 - 200	1000	Clear	M5	2	China
0498xxx.MXTM6	30 - 200	1000	Clear	M6	2	Mexico
0498xxx.MXTM6-CN	30 - 200	1000	Clear	M6	2	China

Materials manufactured in Asia are produced with the same specifications as materials manufactured in North America and meets the same test requirements. Multiple production locations are for capacity expansion only.

### Time-Current Characteristics

% of Rating	Opening Time Min / Max (s)	
	30A-125A	150A-200A
75	- / -	360,000 / ∞
100	360,000 / ∞	- / -
110	14,400 / ∞	- / -
150	90 / 3,600	- / -
200	3 / 100	1 / 15
300	0.3 / 3	- / -
350	- / -	0.3 / 5
500	0.1 / 1	- / -
600	- / -	0.1 / 1

### Time-Current Characteristic Curves

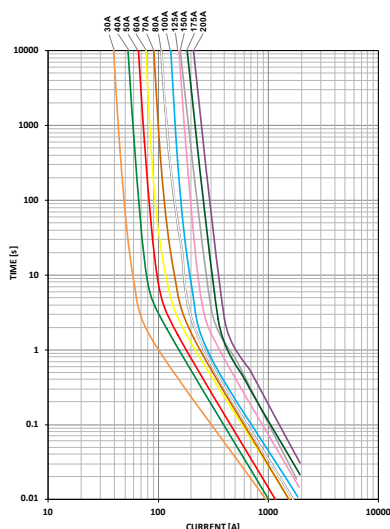

### Ratings

Part Number	Current Rating (A)	Color Code	Test Cable size (mm <sup>2</sup> )	Typ. Voltage Drop (mV)	Typ. Cold Resistance (mΩ)	Typ. I <sup>2</sup> t (A <sup>2</sup> s)
0498030_2	30	Orange	2.5	65	2.06	4,200
0498040_	40	Green	4	65	1.40	10,000
0498050_	50	Red	6	65	1.02	13,000
0498060_	60	Yellow	6	68	0.87	21,700
0498070_	70	Brown	10	70	0.72	24,000
0498080_	80	White	10	58	0.54	24,600
0498100_	100	Blue	16	60	0.46	51,300
0498125_2	125	Pink	25	71	0.39	73,200
0498150_1,2	150	Grey	25	77 <sup>4</sup>	0.32	81,900
0498175_1,2,3	175	Dark Green	25	77 <sup>4</sup>	0.26	100,000
0498200_1,2	200	Purple	25	77 <sup>4</sup>	0.26	125,000

Note 1: Short Circuit Protector only  
 Note 2: Not UL Recognized  
 Note 3: Color Coding deviating from ISO standard  
 Note 4: Measured at 75% I<sub>r</sub>

The typical I<sup>2</sup>t is an average value calculated from the breaking capacity tests by using the melting time before the arcing occurs.

## MIDI®, Clear MIDI®, and One Hole MIDI® Style Bolt-down Fuse Rated 32V

### Dimensions

Dimensions in mm for reference only. See outline drawing for dimensions and tolerances.

#### MIDI 2 Holes M5/M6 versions

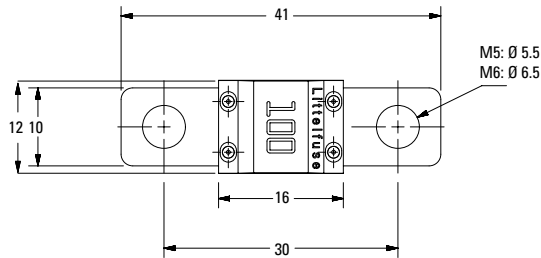

#### MIDI 1 Hole M5 versions

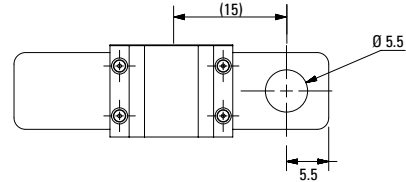

#### MIDI 1 Hole M6 versions

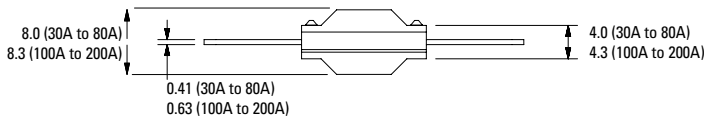
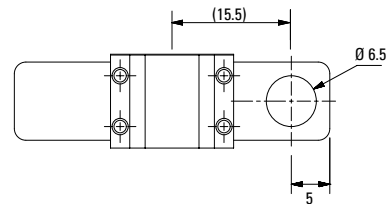

### Typical Derating of Fuse Melting Element

Temperature Security Margin is 20%

Wire Cross Section And Fixture Test Set Up Refer To ISO 8820-5

Please Contact Littelfuse® For Details Regarding Derating Test Set Up

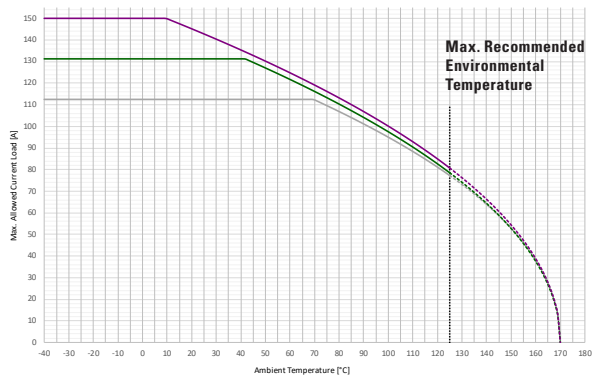
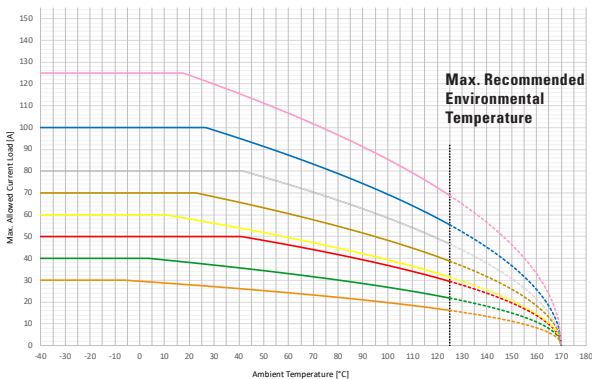

### Temperature Table

	max. allowed current load [A] at ambient temperature (typical derating)						
	-20°C	0°C	20°C	65°C	85°C	110°C	125°C
<b>30A</b>	30	30	28	24	22	18	16
<b>40A</b>	40	40	38	32	29	25	22
<b>50A</b>	50	50	50	45	41	34	29
<b>60A</b>	60	60	58	48	43	36	31
<b>70A</b>	70	70	70	59	53	45	39
<b>80A</b>	80	80	80	72	65	54	47
<b>100A</b>	100	100	100	85	77	64	55
<b>125A</b>	125	125	124	104	94	79	69
<b>150A</b>	113	113	113	113	104	88	77
<b>175A</b>	131	131	131	119	107	90	79
<b>200A</b>	150	150	145	122	110	93	81

Derating curves may change depending on the final condition of the application (terminals characteristics, wire size etc.). Please ask Littelfuse for more information.



MIDI® 70V HP Fuse

## Time-Current Characteristic Curves

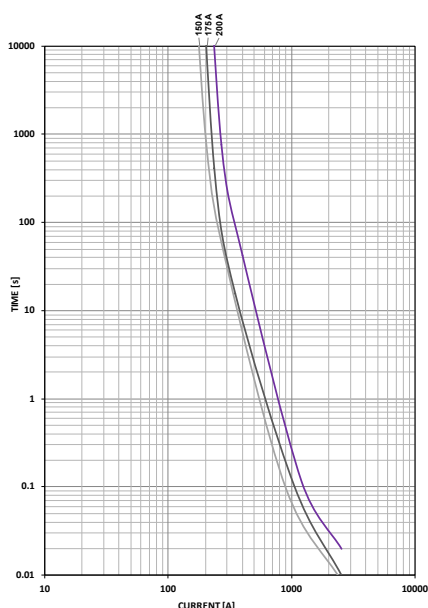
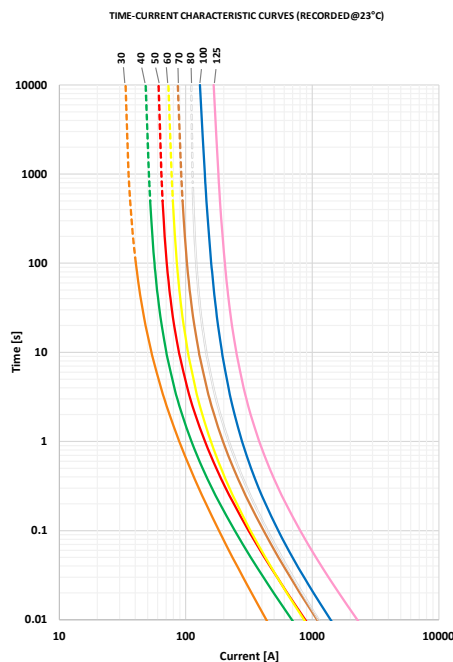

## MIDI® High Performance Fuse Rated 70V

The MIDI® 70V High Performance (HP) Fuse is designed for high current circuit protection up to 125A with "Diffusion Pill Technology." The MIDI® 70V HP features 1MΩ Open State Resistance after fuse opening to guarantee safe interruption at any voltage up to 70V. The MIDI® 70V HP Fuse is an ideal solution for any high current application like fans, heaters and high inrush peak loads. The new added 135% overload gate provides much better wire protection.

### Specifications

Voltage Rating:	70 VDC
Interrupting Rating:	2500A @ 70 VDC
Recommended Environmental Temperature:	-40°C to + 125°C
Terminals Material:	Tin Plated Copper
Housing Material:	PA66 GF25 FR (U.L. 94 Flammability rating – V0)
Mounting Torque M6:	9Nm+/-1Nm
Open State Resistance (after fuse opening)	>1MΩm
Refers To:	ISO 20934 - Type SF36
	Fuse ratings 150A, 175A and 200A deviate from ISO standard. Those three ratings are intended to be used as short circuit
	Standard UL 248-1 as a Special Purpose Fuse in UL File E71611 and Directive 2011/65/EU.

Complies With:



### Ordering Information

Part Number	Rating	Package Size	Bolt Hole Qty
4998xxx.M-M6	30 - 200	500	2
4998xxx.M-1M6	30 - 200	500	1
4998xxx.M-NH	30 - 200	500	0

### Time-Current Characteristics

% of Rating	Opening Time Min / Max (s)	
	30A-125A	150A-200A
100	360,000 / ∞	360,000 / ∞
135	300 / 3,600	-
150	90 / 500	-
200	1 / 50	1 / 50
300	0.3 / 4	0.3 / 4
500	0.1 / 1	0.1 / 1
600	0.07 / 0.7	0.07 / 0.7

### Ratings

Part Number	Current Rating (A)	Color Code	Test Cable Size (mm <sup>2</sup> )	Typ. Voltage Drop (mV)	Typ. Cold Resistance (mΩ)	Typ. I <sup>2</sup> t (A <sup>2</sup> s)
4998030.M_	30	Orange	2.5	100	2.20	3,200
4998040.M_	40	Green	4	94	1.56	4,700
4998050.M_	50	Red	6	86	1.16	7,500
4998060.M_	60	Yellow	6	81	0.94	6,800
4998070.M_	70	Brown	10	76	0.74	10,900
4998080.M_	80	White	10	64	0.57	10,500
4998100.M_	100	Blue	10	68	0.44	18,300
4998125.M_	125	Pink	16	66	0.35	51,300
4998150.M_	150 <sup>1</sup>	Grey	25	<100	-	50,200
4998175.M_	175 <sup>1</sup>	Brown	25	<100	-	57,700
4998200.M_	200 <sup>1</sup>	Purple	35	<100	-	119,100

The typical I<sup>2</sup>t is an average value calculated from the breaking capacity tests by using the melting time before the arcing occurs.

<sup>1</sup> Short Circuit Protectors Only.

## MIDI® High Performance Fuse Rated 70V

### Dimensions

Dimensions in mm for reference only. See outline drawing for dimensions and tolerances.

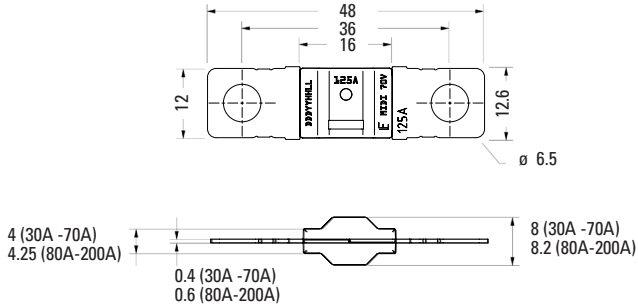

### Temperature Table

	max. allowed current load [A] at ambient temperature (typical derating)						
	-40°C	0°C	20°C	65°C	85°C	110°C	125°C
<b>30A</b>	30	30	29	25	23	19	17
<b>40A</b>	40	40	38	33	30	25	22
<b>50A</b>	50	50	49	42	38	32	28
<b>60A</b>	60	57	54	46	42	35	31
<b>70A</b>	70	70	69	59	53	46	40
<b>80A</b>	80	80	80	70	63	52	45
<b>100A</b>	100	100	94	78	71	59	51
<b>125A</b>	125	125	120	101	91	78	68

### Typical Derating of Fuse Melting Element

Temperature Security Margin is 20%

Please Contact Littelfuse® for Details Regarding Derating Test Set-Up

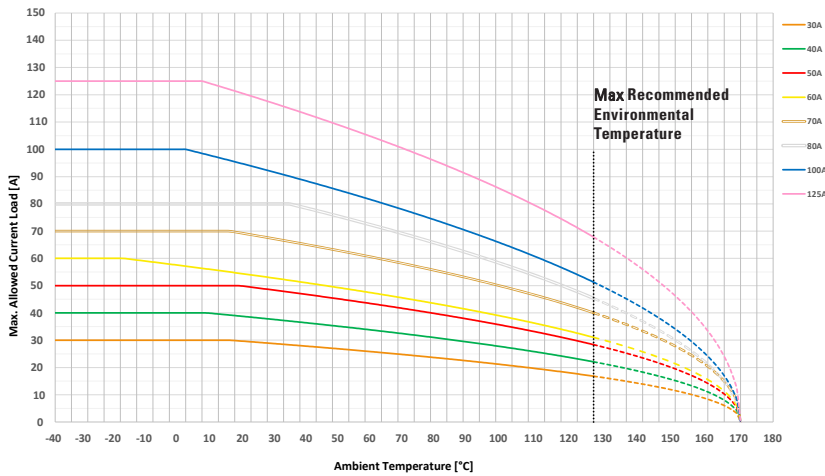

Derating curves may change depending on the final condition of the application (terminals characteristics, wire size etc.). Please ask Littelfuse for more information.

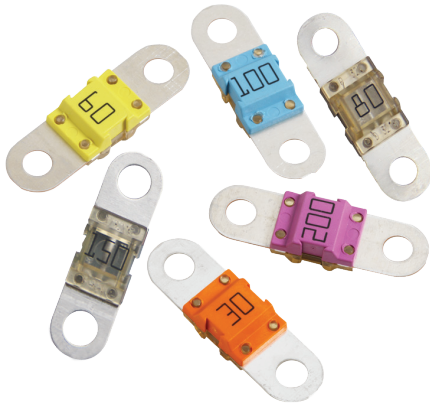

BF1 Fuses



One Hole BF1 Fuses

## Time-Current Characteristic Curves

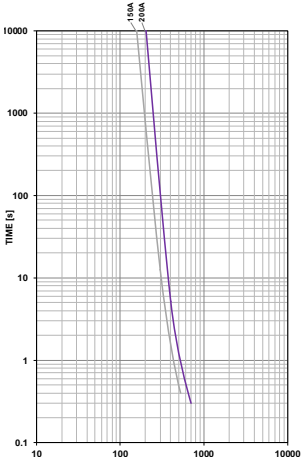
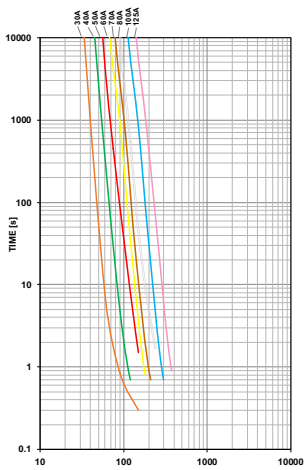

## BF1 Fuse Rated 32V

This BF1 fuse is rated at 32V and offers a bolt-on fuse for high current wiring protection. Current rating 23A - 200A; with transparent housing material for easy detection of blown fuses. One-Hole BF1 fuses have a current rating 60-125A.

### Specifications

Voltage Rating:	32 VDC	
Interrupting Rating:	30A:	1000A @32 VDC
	40A - 150A:	2000A @32 VDC
	200A:	1500A @32 VDC
Recommended Environmental Temperature:	-40° to 125°C	
Terminals Material:	Tin plated copper alloy	
Housing Material:	PET-GF33 (U.L. 94 Flammability rating – V0)	
Clear Housing Material:	PES (U.L. 94 Flammability rating – V0)	
Mounting Torque M5:	4.5 Nm +/- 1Nm	
Mounting Torque M6:	6.0 Nm +/- 1Nm	
Refers to:	ISO 8820-5:2015, UL 248 Special Purpose Fuses	



## Ordering Information

Part Number	Rated Current	Package Size	Bolt Size	Bolt Hole Qty
153.5631.xxx2	30A-200A	1000	M5	2
153.5631.xxx1	30A-200A	10	M5	2
153.7010.xxx2	30A-150A	1000	M6	2
153.7000.xxx2	150-200A	500	M6	2
153.0010.xxx2	60A-125A	1000	M6	1
153.0020.xxx2	30A-200A	500	--	0

## Time-Current Characteristics

% of Rating	Opening Time Min / Max (s)	
	30-125A	150-200A
75	- / -	360,000 / ∞
100	360,000 / ∞	- / -
110	14,400 / ∞	- / -
150	90 / 3,600	- / -
200	3 / 100	1 / 15
300	0.3 / 3	- / -
350	- / -	0.3 / 5
500	0.1 / 1	- / -
600	- / -	0.1 / 1

## Ratings

Part Number	Current Rating (A)	Housing Material Color	Test Cable Size (mm <sup>2</sup> )	Typ. Voltage Drop (mV)	Typ. Cold Resistance (mΩ)	Typ. I <sup>2</sup> t (A <sup>2</sup> s)
153.xxxx.530_	30	Orange	2.5	105	2.70	5,100
153.xxxx.540_	40	Green	4	90	1.56	6,800
153.xxxx.550_	50	Red	6	80	1.03	6,900
153.xxxx.560_	60	Yellow	6	75	0.75	16,200
153.xxxx.570_	70	Brown	10	70	0.64	22,000
153.xxxx.580_	80	White	10	70	0.55	25,600
153.xxxx.610_	100	Blue	16	70	0.44	42,500
153.xxxx.612_	125	Pink	25	70	0.34	62,500
153.xxxx.615_1	150	Grey	25	70	0.29	83,400
153.xxxx.620_3	200	Purple	35	70	0.24	126,000

Note 1: Short Circuit Protector only

The typical I<sup>2</sup>t is an average value calculated from the breaking capacity tests by using the melting time before the arcing occurs.

## BF1 Fuse Rated 32V

### Dimensions

Dimensions in mm for reference only.  
See outline drawing for dimensions and tolerances

### BF1 2 Holes M5/M6 versions

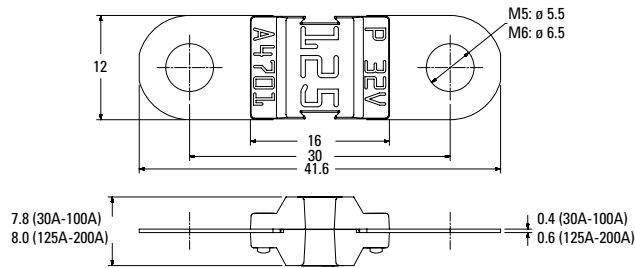

### BF1 1 Hole M6 version

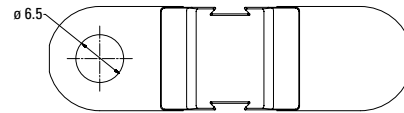

### BF1 No Holes versions

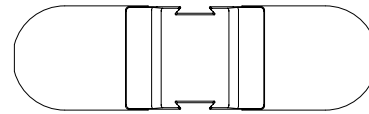

### Typical Derating of Fuse Melting Element

Temperature Security Margin is 20%  
Please contact Littelfuse® for Details Regarding Derating Test Set-Up.

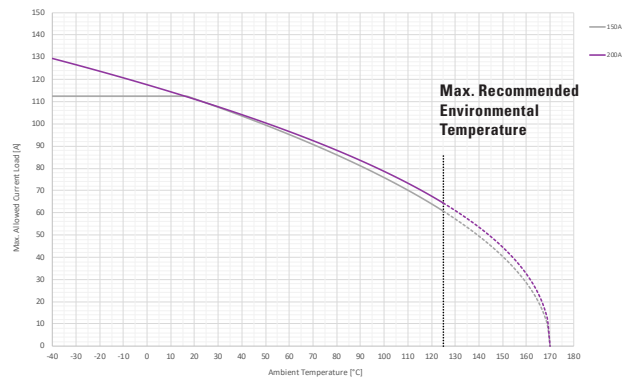
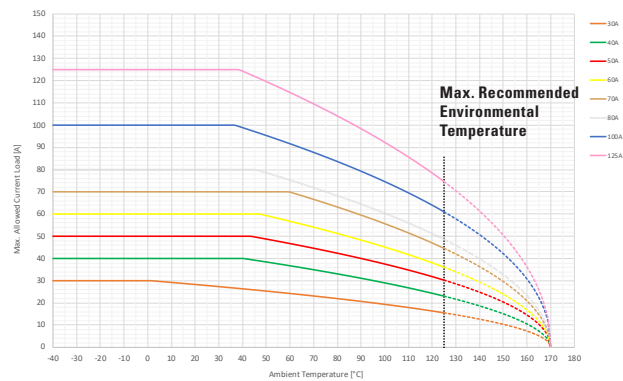

### Temperature Table

	max. allowed current load [A] at ambient temperature (typical derating)						
	-40°C	0°C	20°C	65°C	85°C	110°C	125°C
<b>30A</b>	30	30	28	24	21	18	16
<b>40A</b>	40	40	40	36	32	27	23
<b>50A</b>	50	50	50	46	41	35	30
<b>60A</b>	60	60	60	55	50	42	36
<b>70A</b>	70	70	70	68	61	51	45
<b>80A</b>	80	80	80	74	66	56	49
<b>100A</b>	100	100	100	90	81	70	61
<b>125A</b>	125	125	125	112	101	86	75
<b>150A</b>	113	113	111	93	84	70	61
<b>200A</b>	129	118	111	95	86	73	64

Derating curves may change depending on the final condition of the application (terminals characteristics, wire size etc.).  
Please ask Littelfuse for more information.



## BF1 Fuses Rated 58V

This BF1 fuse is rated at 58V and offers a bolt-on fuse for high current wiring protection. Current rating 30A - 200A; with transparent housing material for easy detection of blown fuses.

### Specifications

Voltage Rating:	58 VDC
Interrupting Rating:	1000A @58 VDC
Recommended Environmental Temperature:	-40° to 125°C
Terminals Material:	Tin plated copper alloy
Housing Material:	PET-GF33 (U.L. 94 Flammability rating – V0)
Clear Housing Material:	PES (U.L. 94 Flammability rating – V0)
Mounting Torque M5:	4.5 Nm +/- 1Nm
Mounting Torque M6:	6.0 Nm +/- 1Nm
Refers to:	ISO 8820-5:2015, UL 248 Special Purpose Fuses

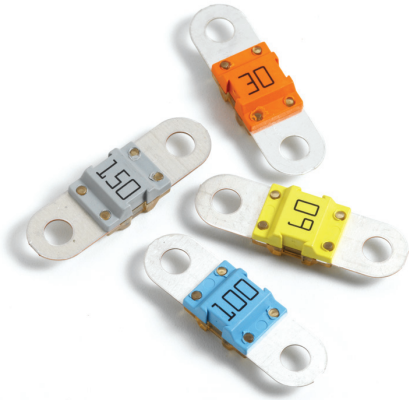

### Time-Current Characteristic Curves

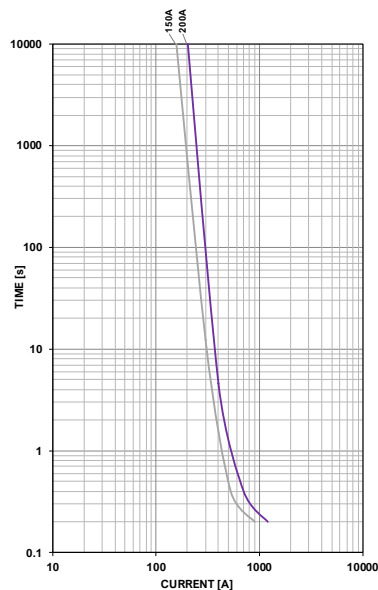
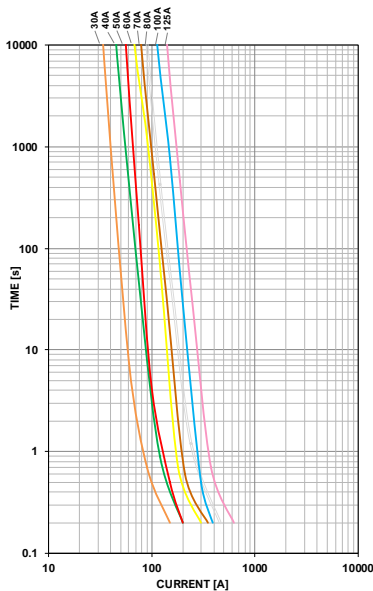

### Ordering Information

Part Number	Rating	Package Size	Bolt Size	Bolt Hole Qty
142.5631.xxxx	30 - 200	500	M5	2
142.7010.xxxx	30 - 200	500	M6	2
142.0020.xxxx	30 - 200	500	N/A	0

### Time-Current Characteristics

% of Rating	Opening Time Min / Max (s)	
	30-125A	150-200A
75	- / -	360,000 / ∞
100	360,000 / ∞	- / -
110	14,400 / ∞	- / -
150	90 / 3,600	- / -
200	3 / 100	1 / 15
300	0.3 / 3	- / -
350	- / -	0.3 / 5
500	0.1 / 1	- / -
600	- / -	0.1 / 1

### Ratings

Part Number M5	Part Number M6	Current Rating (A)	Housing Material Color	Test Cable Size (mm <sup>2</sup> )	Typ. Voltage Drop (mV)	Typ. Cold Resistance (mΩ)	Typ. I <sup>2</sup> t (A <sup>2</sup> s)
142.5631.5302 <sup>1</sup>	142.7010.5302 <sup>1</sup>	30	Orange	2.5	105	2.70	5,100
142.5631.5402	142.7010.5402	40	Green	4	90	1.56	6,800
142.5631.5502	142.7010.5502	50	Red	6	80	1.03	6,900
142.5631.5602	142.7010.5602	60	Yellow	6	75	0.75	16,200
142.5631.5702	142.7010.5702	70	Brown	10	70	0.64	22,000
142.5631.5802	142.7010.5802	80	White	10	70	0.55	25,600
142.5631.6102	142.7010.6102	100	Blue	16	70	0.44	42,500
142.5631.6122	142.7010.6122	125	Pink	25	70	0.34	62,500
142.5631.6152	142.7010.6152	150	Grey	25	70	0.29	83,400
142.5631.6202 <sup>2</sup>	142.7010.6202	200	Purple	35	70	0.24	126,000

Note 1: Not UL rated  
 Note 2: Short Circuit Protector only

The typical I<sup>2</sup>t is an average value calculated from the breaking capacity tests by using the melting time before the arcing occurs.

## BF1 Fuse Rated 58V

### Dimensions

Dimensions in mm for reference only.  
See outline drawing for dimensions and tolerances.

#### BF1 2 Holes M5/M6

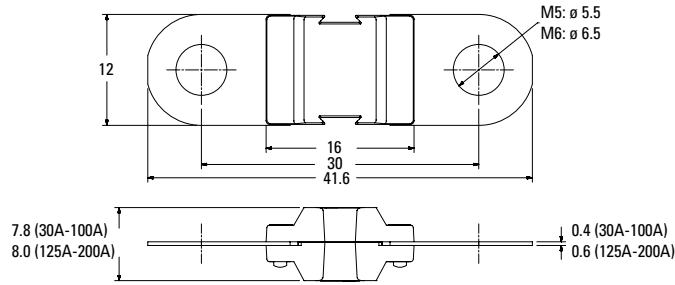

#### BF1 No Holes versions

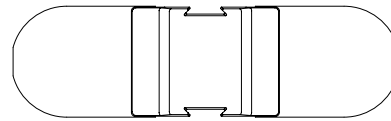

### Typical Derating of Fuse Melting Element

Temperature Security Margin is 20%  
Please contact Littelfuse® for Details Regarding Derating Test Set-Up.

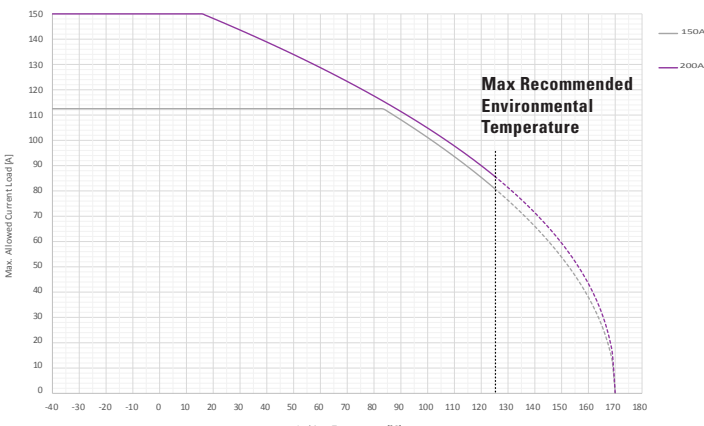
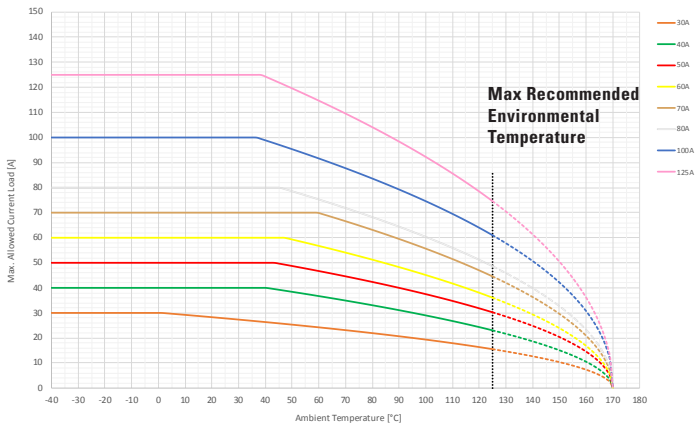

### Temperature Table

	max. allowed current load [A] at ambient temperature (typical derating)						
	-40°C	0°C	20°C	65°C	85°C	110°C	125°C
<b>30A</b>	30	30	28	24	21	18	16
<b>40A</b>	40	40	40	36	32	27	23
<b>50A</b>	50	50	50	46	41	35	30
<b>60A</b>	60	60	60	55	50	42	36
<b>70A</b>	70	70	70	68	61	51	45
<b>80A</b>	80	80	80	74	66	56	49
<b>100A</b>	100	100	100	90	81	70	61
<b>125A</b>	125	125	125	112	101	86	75
<b>150A</b>	113	113	113	113	111	94	81
<b>200A</b>	150	150	148	126	115	98	86

Derating curves may change depending on the final condition of the application (terminals characteristics, wire size etc.).  
Please ask Littelfuse for more information.



BF2 Fuses

## BF2 Fuses Rated 32V

This BF2 fuse is rated at 32V and offers a bolt-on fuse for high current wiring protection. Current rating 100A - 500A; with transparent housing material for easy detection of blown fuses.

### Specifications

Voltage Rating:	32 VDC
Interrupting Ratings:	100A - 300A: 2000A @ 32 VDC 400A - 500A: 1500A @ 32 VDC
Recommended Environmental Temperature:	-40°C to + 125°C
Terminals Material:	Tin plated copper alloy
Housing Material:	PET-GF33 (U.L. 94 Flammability rating – V0)
Clear Housing Material:	PES (U.L. 94 Flammability rating – V0)
Mounting Torque M8:	12.0 Nm +/- 1Nm
Mounting Torque M6:	6.0 Nm +/- 1Nm
Refers to:	ISO 8820-5:2015, UL 248 Special Purpose



### Ordering Information

Part Number	Rating	Package Size
<b>Standard M8 Holes</b>		
153.5395.xxxx	100 - 500	200
<b>M6 Holes</b>		
153.7011.xxxx	100 - 500	200

### Time Current Characteristics

% of Rating	Opening Time Min / Max (s)	
	100A - 250A	300A - 500A
75	- / -	14,400 / ∞
100	14,400 / ∞	- / -
135	120 / 1,800	- / -
200	1 / 15	1 / 15
350	0.3 / 5	0.5 / 5
600	0.1 / 1	0.1 / 1

### Time-Current Characteristic Curves

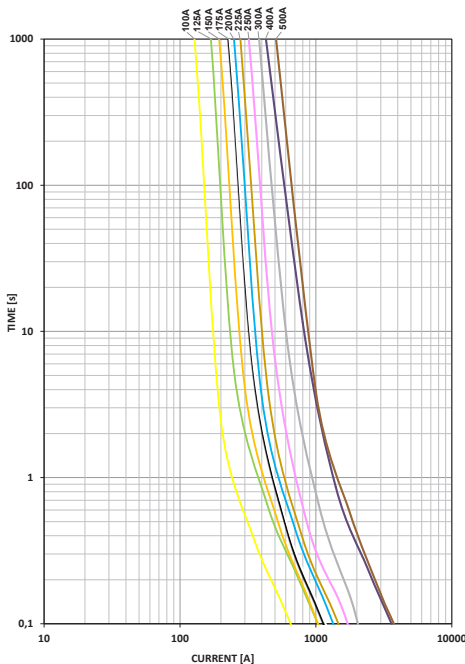

### Ratings

Part Number	Current Rating (A)	Housing Color	Test Cable Size (mm <sup>2</sup> )	Typ. Voltage Drop (mV)	Typ. Cold Resistance (mΩ)	Typ. I <sup>2</sup> t (A <sup>2</sup> s)
153.xxxx.6102	100	Yellow	16	102	0.70	46,800
153.xxxx.6122	125	Green	25	81	0.52	118,100
153.xxxx.6152	150	Orange	25	77	0.42	113,400
153.xxxx.6172	175	White	25	104	0.36	154,400
153.xxxx.6202	200	Blue	35	102	0.34	288,000
153.xxxx.6222	225	Brown	35	107	0.29	236,000
153.xxxx.6252	250	Pink	50	86	0.25	292,500
153.xxxx.6302 <sup>1</sup>	300	Grey	70	68	0.21	486,000
153.xxxx.6402 <sup>1</sup>	400	Purple	70	70	0.13	964,000
153.xxxx.6502 <sup>1</sup>	500	Brown	70	60	0.12	1,449,000

Note 1: Short Circuit Protector only

The typical I<sup>2</sup>t is an average value calculated from the breaking capacity tests by using the melting time before the arcing occurs.

## BF2 Fuse Rated 32V

### Dimensions

Dimensions in mm for reference only.  
See outline drawing for dimensions and tolerances.

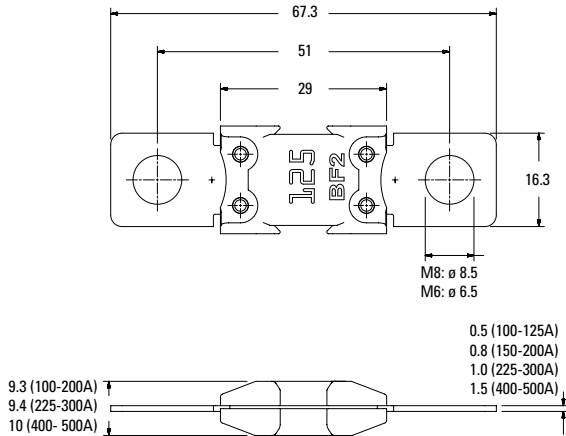

### Typical Derating of Fuse Melting Element

Temperature Security Margin is 20%  
Please contact Littelfuse® for Details Regarding Derating Test Set-Up.

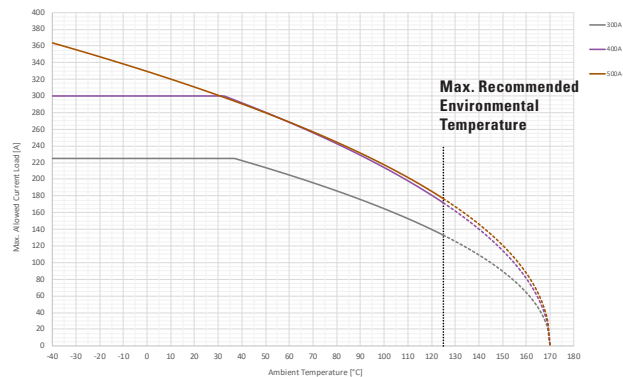
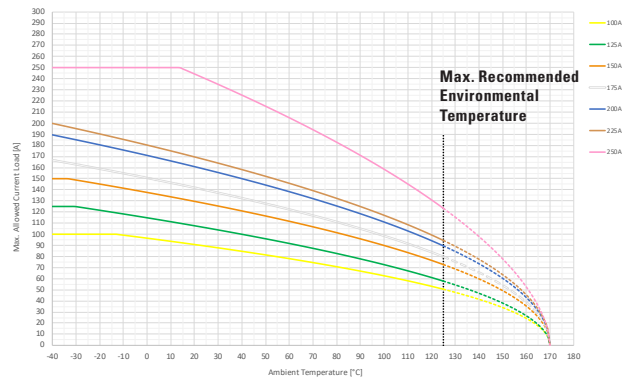

### Temperature Table

	max. allowed current load [A] at ambient temperature (typical derating)						
	-40°C	0°C	20°C	65°C	85°C	110°C	125°C
<b>100A</b>	100	96	91	76	69	58	50
<b>125A</b>	125	115	108	90	80	67	58
<b>150A</b>	150	138	130	109	99	83	73
<b>175A</b>	167	151	142	120	108	92	80
<b>200A</b>	189	171	161	135	122	103	90
<b>225A</b>	200	180	170	143	129	109	94
<b>250A</b>	250	250	244	200	177	145	123
<b>300A</b>	225	225	225	201	181	153	133
<b>400A</b>	300	300	300	262	236	198	172
<b>500A</b>	364	329	311	263	238	202	177

Derating curves may change depending on the final condition of the application (terminals characteristics, wire size etc.).  
Please ask Littelfuse for more information.

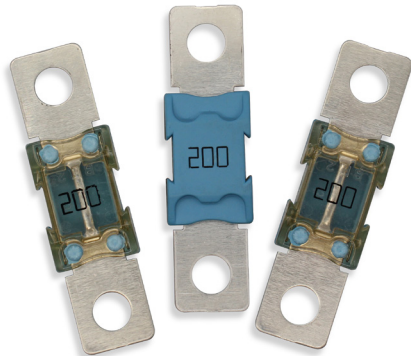

BF2 Fuses

## BF2 Fuses Rated 58V

This BF2 fuse is rated at 58V and offers a bolt-on fuse for high current wiring protection. Current rating 100A - 300A; with transparent housing material for easy detection of blown fuses.

### Specifications

Voltage Rating:	58 VDC
Interrupting Ratings:	1000A @ 58 VDC
Recommended Environmental Temperature:	-40°C to + 125°C
Terminals Material:	Tin plated copper alloy
Housing Material:	PET-GF33 (U.L. 94 Flammability rating – V0)
Clear Housing Material:	PES (U.L. 94 Flammability rating – V0)
Mounting Torque M8:	12.0 Nm +/- 1Nm
Refers to:	ISO 8820-5:2015, UL 248 Special Purpose



### Time-Current Characteristic Curves

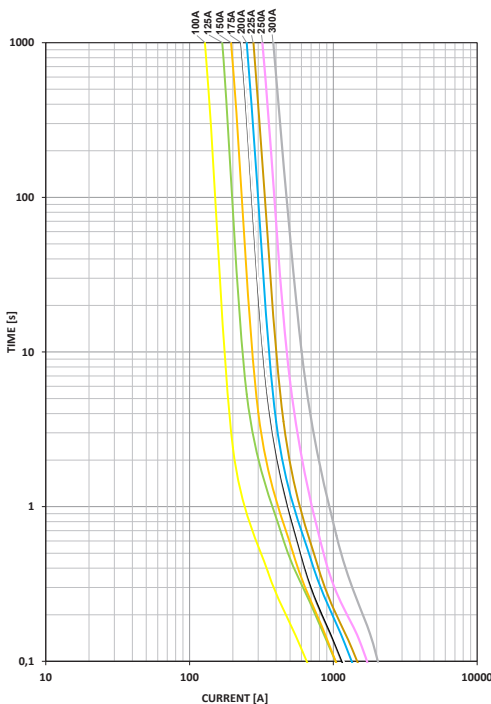

### Ordering Information

Part Number	Rating	Package Size
142.5395.xxxx	100 - 300	200

### Time Current Characteristics

% of Rating	Opening Time Min / Max (s)	
	100A - 250A	300A
75	- / -	- / -
100	14,400 / ∞	14,400 / ∞
135	120 / 1,800	- / -
200	1 / 15	1 / 15
350	0.3 / 5	0.5 / 5
600	0.1 / 1	0.1 / 1

### Ratings

Part Number	Current Rating (A)	Housing Color	Test Cable Size (mm <sup>2</sup> )	Typ. Voltage Drop (mV)	Typ. Cold Resistance (mΩ)	Typ. I <sup>2</sup> t (A <sup>2</sup> s)
142.5395.6102	100	Yellow	16	102	0.70	46,800
142.5395.6122	125	Green	25	81	0.52	118,100
142.5395.6152	150	Orange	25	77	0.42	113,400
142.5395.6172	175	White	25	104	0.36	154,400
142.5395.6202	200	Blue	35	102	0.34	288,000
142.5395.6222	225	Brown	35	107	0.29	236,000
142.5395.6252	250	Pink	50	86	0.25	292,500
142.5395.6302 <sup>1</sup>	300	Grey	70	68	0.21	486,000

Note 1: Short Circuit Protector only

The typical I<sup>2</sup>t is an average value calculated from the breaking capacity tests by using the melting time before the arcing occurs.

## BF2 Fuse Rated 58V

### Dimensions

Dimensions in mm for reference only.  
See outline drawing for dimensions and tolerances.

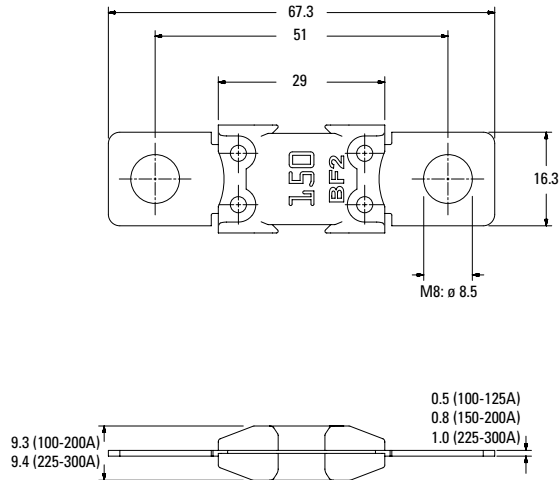

### Typical Derating of Fuse Melting Element

Temperature Security Margin is 20%  
Wire Cross Section And Fixture Test Set Up Refer To ISO 8820-5:2015  
Please contact us for the details of Test Set Up Definition

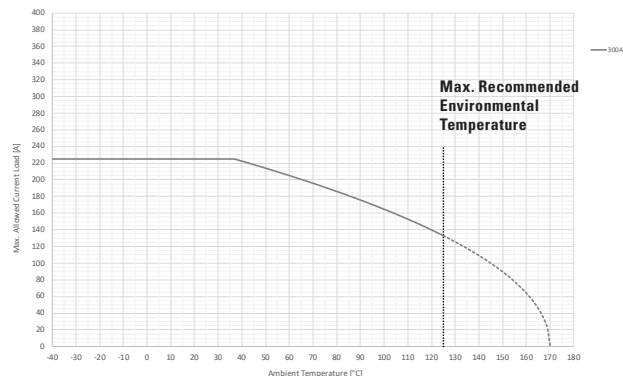
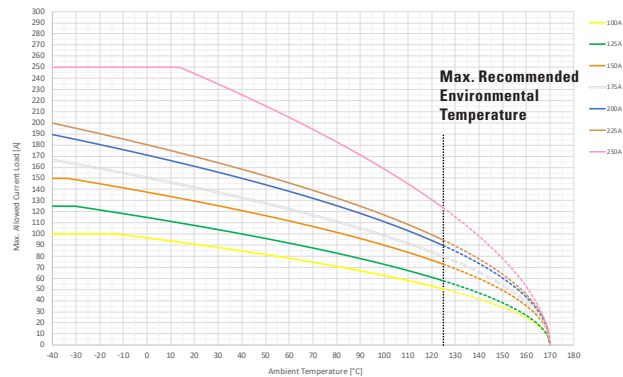

### Temperature Table

	max. allowed current load [A] at ambient temperature (typical derating)						
	-40°C	0°C	20°C	65°C	85°C	110°C	125°C
<b>100A</b>	100	96	91	76	69	58	50
<b>125A</b>	125	115	108	90	80	67	58
<b>150A</b>	150	138	130	109	99	83	73
<b>175A</b>	167	151	142	120	108	92	80
<b>200A</b>	189	171	161	135	122	103	90
<b>225A</b>	200	180	170	143	129	109	94
<b>250A</b>	250	250	244	200	177	145	123
<b>300A</b>	225	225	225	201	181	153	133

Derating curves may change depending on the final condition of the application (terminals characteristics, wire size etc.).  
Please ask Littelfuse for more information.



CF Fuses

## CF Fuses Rated 58V from 50A-300A

Main Fuse for mounting with battery clamp on the battery pole with transparent cover material for visual inspection of melting element.

### Specifications

Ratings up to 125A	
Operating Temperature Range:	-40°C to +105°C
Terminals:	Sn plated zinc alloy
Ratings higher than 125A	
Operating Temperature Range:	-40°C to +125°C
Terminals:	Sn plated copper alloy
Insulating Body Material:	Ceramic
Cover Material:	PES
	Visible melting-element
Interrupting Rating:	2,000A @58VDC
Complies with:	ISO 8820-6, DIN 72581-5, UL 248 Special Purpose Fuses
cULus Recognized:	File No. E211637



### Ordering Information

### Time-Current Characteristics

Part Number	Package Size	% of Rating	Opening Time Min / Max (s)
155.0892.xxx1	100	100	360,000 s / -
		135	- / 3,600 s
		150	1 s / 600 s
		200	0.200 s / 60 s
		300	0.050 s / 1.5 s
		400	0.020 s / 0.50 s
		600	- / 0.20 s

### Ratings

Part Number	Current Rating (A)	Typ. Voltage Drop (mV)	Cold Resistance (mΩ)	I <sup>2</sup> t (A <sup>2</sup> s)
155.0892.5501	50	100	1.20	1,900
155.0892.5751	75	90	0.60	12,000
155.0892.6101	100	80	0.60	14,000
155.0892.6121	125	75	0.45	51,000
155.0892.6151	150	70	0.35	63,800
155.0892.6171	175	70	0.25	120,000
155.0892.6201	200	65	0.25	172,800
155.0892.6251	250	70	0.20	330,000
155.0892.6301	300	70	0.15	372,000

Insert CF8-Fuse links only in conjunction with the insulating nuts, see Section "Fuse Holders." Corresponding battery clamp see Section "Fuse Holders."

### Dimensions

Dimensions in mm

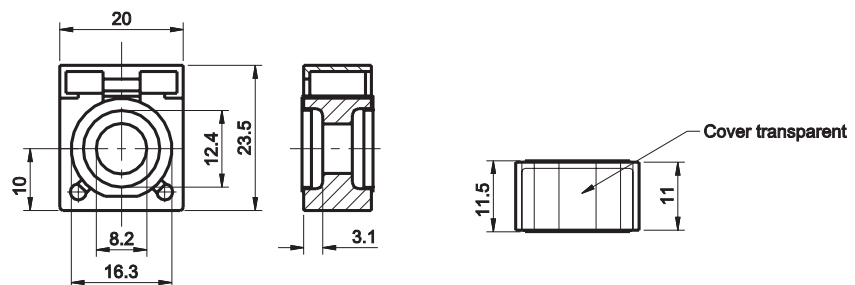

### Pre-Arcing Time-Limits

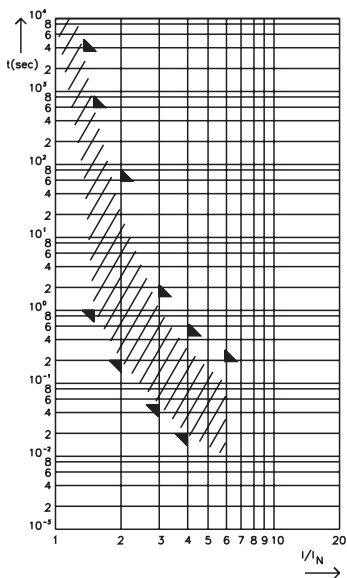

$FI = 1.25$  (max. operating current:  $0.8 \times I_{rat}$  at 23°C)



## Fuse Strips with Housing Rated 36V - SPECIAL PURPOSE FUSES (NOT INTENDED FOR AUTOMOTIVE or TRUCK APPLICATIONS)

Housed fuse strips with window for visual inspection of melting element. Current rating 30A - 150A, 36VDC. 90° fork type lugs.

### Specifications

Voltage Rating:	36 VDC
Interrupt Ratings:	up to 375A
Operating Temperature Range:	-40° to 125°C
Insulating Body:	Out of ceramic
Metal Parts:	Zinc-alloy
Complies with:	DIN 72581/2



### Ordering Information

Part Number	Package Size
156.5611.xxx1	50

### Time-Current Characteristics

% of Rating	Opening Time Min / Max (s)
130	3,600 s / -
250	- / 60 s

### Ratings

Part Number	Current Rating (A)*	Typ. Voltage Drop (mV)	Material Thickness "S" (mm)
156.5611.5301	30	70	0.25
156.5611.5401	40	70	0.20
156.5611.5501	50	70	0.25
156.5611.5601	60	70	0.40
156.5611.5701	70	70	0.45
156.5611.5801	80	70	0.50
156.5611.6101	100	70	0.70
156.5611.6111	120	70	0.70
156.5611.6121	125	70	0.70
156.5611.6151	150	70	1.00

### Pre-Arcing Time-Limits

TIME-CURRENT CHARACTERISTIC CURVES

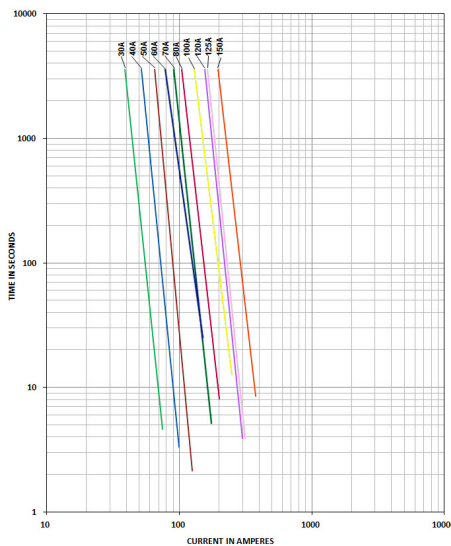

FI = 1.00 (max. operating current : 1.0 x I<sub>rat</sub> at 23°C)

Corresponding holder see Section "Fuse Holders."

\*Metal parts in compliance with DIN 7258½. Fuses with housings not mentioned in the standards.

### Dimensions

Dimensions in mm

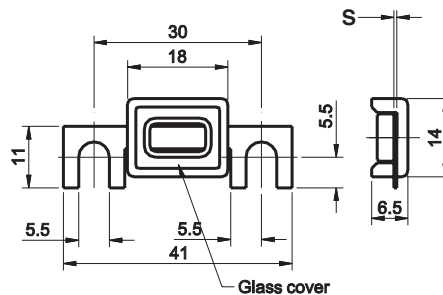



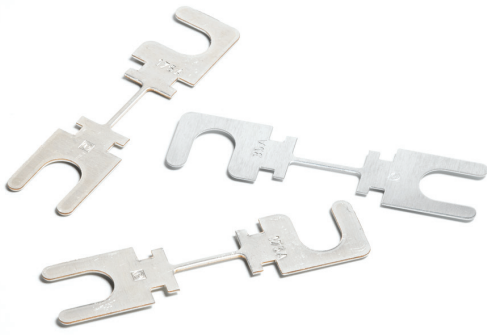

## Fuse Strips Rated 48V - SPECIAL PURPOSE FUSES (NOT INTENDED FOR AUTOMOTIVE OR TRUCK APPLICATIONS)

Non-housed fuse strips for battery powered fuses rated at 48VDC. 90° and straight fork type lugs.

### Specifications

Voltage Rating:	48 VDC
Interrupt Ratings:	up to 3000A
Operating Temperature Range:	-40° to 125°C
Metal Parts:	35 A - 80 A: Zinc-alloy 100A - 500 A: Copper Cu, gal. Sn
Complies with:	DIN 43560-1



### Dimensions

Dimensions in mm

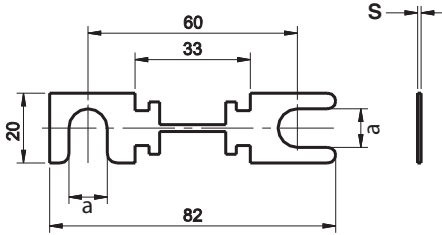

### Pre-Arcing Time-Limits

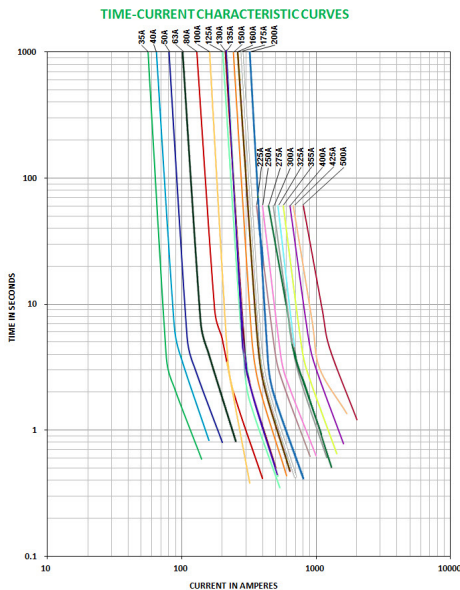

FI = 1.00 (max. operating current:  $1.0 \times I_{rat}$  at 23°C)

### Ordering Information

Part Number	Package Size
157.5700.xxx1	50
157.5916.xxx1	50

### Time-Current Characteristics

% of Rating	Opening Time Min / Max (s)	
	35-200	225 - 500
150	3,600 s / -	- / -
160	- / -	60 s / -
220	- / 60 s	
250	0.8 s / 10 s	
400	0.20 / 2 s	

### Ratings

Part Number		Current Rating (A)	Typ. Voltage Drop (mV)	Breaking Capacity (VDC/A)	Material Thickness "S" (mm)
a = 11 mm	a = 9 mm*				
157.5700.5351	157.5916.5351	35	125	48/210	0.6
157.5700.5401	-	40	125	48/240	0.6
157.5700.5501	157.5916.5501	50	125	48/300	0.6
157.5700.5631	157.5916.5631	63	125	48/378	0.6
157.5700.5801	157.5916.5801	80	125	48/480	0.6
157.5700.6101	157.5916.6101	100	125	48/600	0.5
157.5700.6121	157.5916.6121	125	125	48/750	0.8
157.5700.6131	157.5916.6131	130	125	48/780	0.8
157.5700.6141	-	135	125	48/810	0.8
157.5700.6151	-	150	125	48/900	0.8
157.5700.6161	157.5916.6161	160	125	48/960	1.0
157.5700.6171	-	175	125	48/1050	1.0
157.5700.6201	157.5916.6201	200	125	48/1200	0.8
157.5700.6231	-	225	125	48/1350	0.5
157.5700.6251	157.5916.6251	250	125	48/1500	0.5
157.5700.6271	-	275	125	48/1650	0.8
157.5700.6301	-	300	125	48/1800	0.8
157.5700.6331	-	325	125	48/1950	0.8
157.5700.6351	-	355	125	48/2130	0.8
157.5700.6401	-	400	125	48/2400	0.8
157.5700.6421	-	425	125	48/2550	1.0
157.5700.6501	-	500	125	48/3000	1.0

Corresponding holders = 177.5701.0001 and 177.5702.0001."



## Fuse Strips with Housing Rated 48V - SPECIAL PURPOSE FUSES (NOT INTENDED FOR AUTOMOTIVE OR TRUCK APPLICATIONS)

Housed fuse strips for battery-powered vehicles. Current rating 35A - 500A, 48 VDC. 90° and straight fork type lugs. With window for visual inspection of melting element.

### Specifications

Voltage Rating:	48 VDC
Interrupt Ratings:	up to 3000A
Operating Temperature Range:	-40° to 125°C
Metal Parts:	35A - 80A: Zinc-alloy 100A - 500A: Copper Cu, gal. Sn
Complies with:	UL 248 Special Purpose Fuses
cULus Recognized:	File No. E211637



### Dimensions

Dimensions in mm

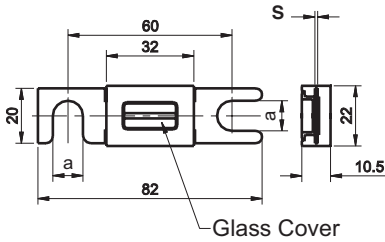

### Pre-Arcing Time-Limits

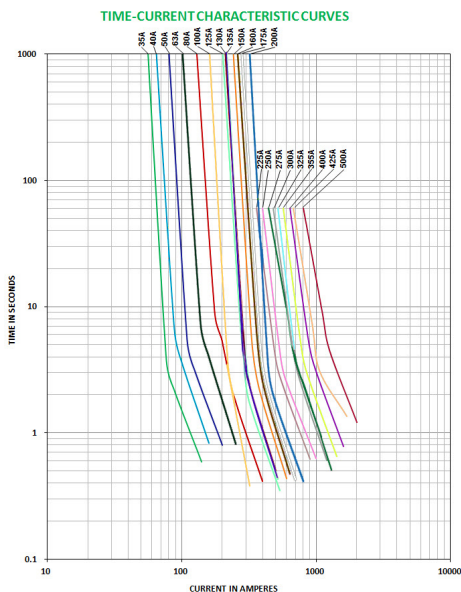

FI = 1.00 (max. operating current:  $1.0 \times I_{rat}$  at 23°C)

### Ordering Information

Part Number	Package Size
157.5701.xxx1	50
157.5917.xxx1	50

### Time-Current Characteristics

% of Rating	Opening Time Min / Max (s)	
	35-200	225 - 500
150	3,600 s / -	- / -
160	- / -	60 s / -
220	- / 60 s	
250	0.8 s / 10 s	
400	0.20 / 2 s	

### Ratings

Part Number		Current Rating (A)	Typ. Voltage Drop (mV)	Breaking Capacity (VDC/A)	Material Thickness "S" (mm)
a = 11 mm	a = 9 mm*				
157.5701.5351	157.5917.5351	35	125	48/210	0.6
157.5701.5401	-	40	125	48/240	0.6
157.5701.5501	157.5917.5501	50	125	48/300	0.6
157.5701.5631	157.5917.5631	63	125	48/378	0.6
157.5701.5801	157.5917.5801	80	125	48/480	0.6
157.5701.6101	157.5917.6101	100	125	48/600	0.5
157.5701.6121	157.5917.6121	125	125	48/750	0.8
157.5701.6131	-	130	125	48/780	0.8
157.5701.6141	-	135	125	48/810	0.8
157.5701.6151	157.5917.6151	150	125	48/900	0.8
157.5701.6161	157.5917.6161	160	125	48/960	1.0
157.5701.6171	157.5917.6171	175	125	48/1050	1.0
157.5701.6201	157.5917.6201	200	125	48/1200	0.8
157.5701.6231	157.5917.6231	225	125	48/1350	0.5
157.5701.6251	157.5917.6251	250	125	48/1500	0.5
157.5701.6271	157.5917.6281	275	125	48/1650	0.8
157.5701.6301	-	300	125	48/1800	0.8
157.5701.6331	157.5917.6331	325	125	48/1950	0.8
157.5701.6351	157.5917.6351	355	125	48/2130	0.8
157.5701.6401	-	400	125	48/2400	0.8
157.5701.6421	157.5917.6421	425	125	48/2550	1.0
157.5701.6501	157.5917.6501	500	125	48/3000	1.0

Corresponding holder see Section "Fuse Holders."

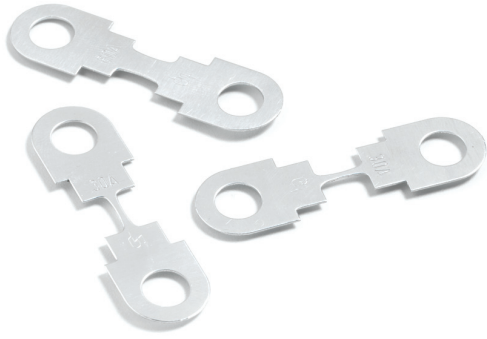

## HSB Fuses Rated 32V

Non-housed fuse strips for rated voltage up to 32 VDC. Current rating 30 A -175 A. Ring type lugs.

### Specifications

Voltage Rating:	32 VDC
Interrupt Ratings:	1000A
Operating Temperature Range:	-40° to 125°C
Material:	Zinc-alloy
Connections:	Zinc-alloy 2 x M6 bolts, distance 30 mm
Torque:	4 Nm +/- 1 Nm

**RoHS**

### Ordering Information

Part Number	Package Size
156.5677.xxx1	100
156.5677.xxx2	10000

### Time-Current Characteristics

% of Rating	Opening Time Min / Max (s)
100	∞ / -
125	360,000 s / -
300	0.100 s / 10 s
600	0.020 s / 1 s
1000	0.010 s / 0.300 s

### Ratings

Part Number	Current Rating (A)	Typ. Voltage Drop (mV)	Cold Resistance (mΩ)	I <sup>2</sup> t (A <sup>2</sup> s)	Material Thickness "S" (mm)
156.5677.530_	30	44	1.33	3800	0.4
156.5677.540_	40	40	0.89	11200	0.4
156.5677.550_	50	44	0.72	21300	0.4
156.5677.560_	60	38	0.58	41400	0.4
156.5677.580_	80	40	0.43	44800	0.8
156.5677.611_	110	40	0.31	139000	0.8
156.5677.615_	150	52	0.23	465000	0.8
156.5677.617_	175	46	0.22	560000	0.8

### Pre-Arcing Time-Limits

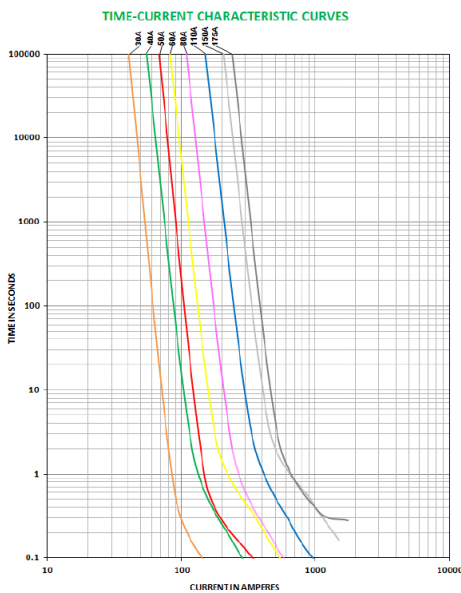

FI = 1.00 (max. operating current:  
1.0 x I<sub>rat</sub> at 23°C)

### Dimensions

Dimensions in mm

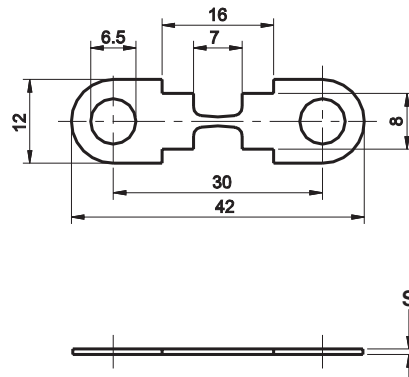



## Fuse Strips with Rated 36V - SPECIAL PURPOSE FUSES (NOT INTENDED FOR AUTOMOTIVE OR TRUCK APPLICATIONS)

Non-housed fuse strips for Diesel vehicles. Current rating 25A - 150A, 36 VDC. 90° fork type lugs.

### Specifications

Voltage Rating:	36 VDC
Interrupt Ratings	up to 625A
Operating Temperature Range:	-40° to 125°C
Material:	Zinc-alloy
Complies with:	DIN 72581/2

**RoHS**

### Ordering Information

Part Number	Package Size	% of Rating	Opening Time Min / Max (s)
156.5610.xxx1	100	130	3,600 s / -
156.5610.xxx2	2000	250	- / 60 s

### Time-Current Characteristics

### Ratings

Part Number	Current Rating (A)	Typ. Voltage Drop (mV)	Material Thickness "S" (mm)
156.5610.525_	25*	70	0.20
156.5610.530_	30	70	0.25
156.5610.540_	40*	70	0.20
156.5610.550_	50	70	0.25
156.5610.560_	60*	70	0.40
156.5610.570_	70*	70	0.45
156.5610.580_	80	70	0.50
156.5610.610_	100	70	0.70
156.5610.611_	120*	70	0.70
156.5610.612_	125*	70	0.70
156.5610.615_	150*	70	1.00
156.5610.625_	250*	70	2.00

\*Not mentioned in the standards  
Corresponding holder see Section "Fuse Holders."

### Pre-arcing Time-limits

TIME-CURRENT CHARACTERISTIC CURVES

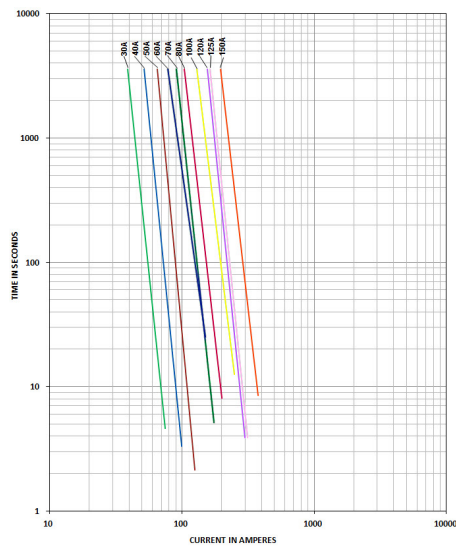

FI = 1.00 (max. operating current: 1.0 x I<sub>rat</sub> at 23°C)

### Dimensions

Dimensions in mm

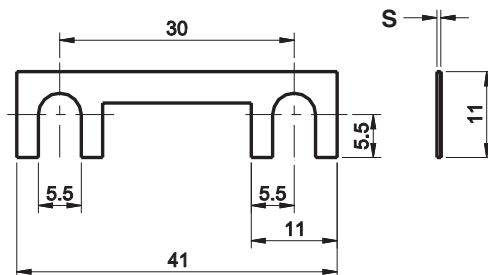



## SMD FUSES

---

Low Current SMD Fuses Rated 18V



SMD Autofuse

## SMD Autofuse Rated 18V

The SMD Autofuse is a new surface-mountable fuse that's designed to perform similarly to traditional automotive blade fuses where ease of replacement is not desired or required. The implementation of the SMD autofuse offers space savings and systems savings without performance sacrifices.

### Specifications

Voltage Rating:	18 VDC
Interrupting Rating:	1000A @18 VDC
Recommended Environmental Temperature:	-40°C to +105°C
Terminals Material:	Tin plated zinc alloy
Housing Material:	LCP (U.L. 94 Flammability Rating - HB)
Net Weight Per Fuse:	0.27±15% gr
Complies with:	SAE 2741 and ISO 8820-12 in reference to electrical and environmental performance requirements



### Time-Current Characteristic Curves

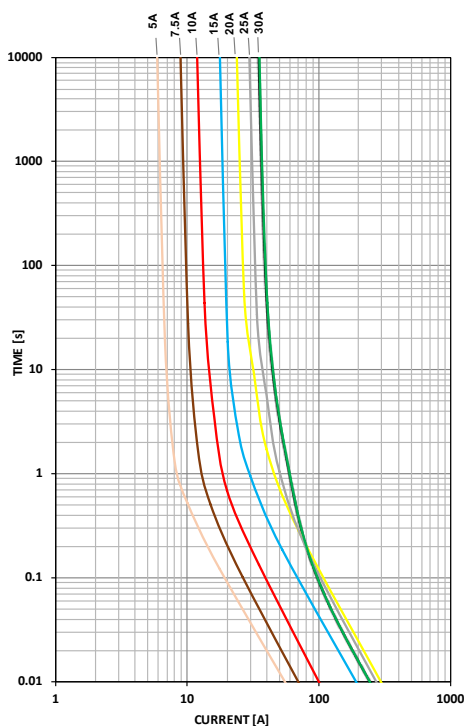

### Ordering Information

Part Number	Rating	Package Size
0317xxx.M	5 - 30 & SHUNT	1000

### Time-Current Characteristics

% of Rating	Opening Time Min / Max (s)
110	360,000 / ∞
135	0.75 / 120
160	0.3 / 50
200	0.15 / 5
350	0.04 / 0.5
600	0.02 / 0.1

### Ratings

Part Number	Current Rating (A)	Typ. Voltage Drop (mV)	Typ. Cold Resistance (mΩ)	Typ. I <sup>2</sup> t (A <sup>2</sup> s)
0317005.M <sup>1</sup>	5	121	16.24	26
031707.5M <sup>1</sup>	7.5	104	9.81	36
0317010.M	10	90	6.73	71
0317015.M <sup>1</sup>	15	109	4.61	320
0317020.M	20	84	3.21	728
0317025.M <sup>1</sup>	25	87	2.43	652
0317030.M <sup>1</sup>	30	75	1.85	503
0317900.M <sup>1</sup>	SHUNT	50	1.39	--

Note 1: Under development

The typical I<sup>2</sup>t is an average value calculated from the breaking capacity tests by using the melting time before the arcing occurs.

### Dimensions

Dimensions in mm for reference only. See outline drawing for dimensions and tolerances

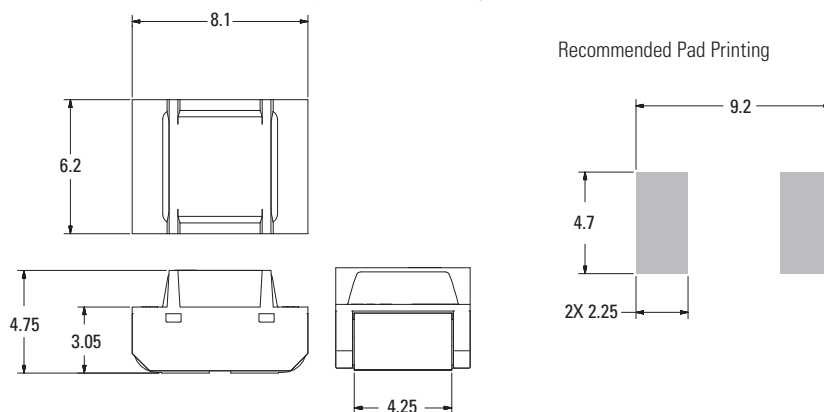

## SMD Autofuse Rated 18V

### Typical Derating Of Fuse Melting Element

Temperature Security Margin is 20%  
Trace Cross-Section Based On IPC Standard (70% In and 30K rise)  
Please contact Littelfuse® for details regarding Derating Test Set Up.

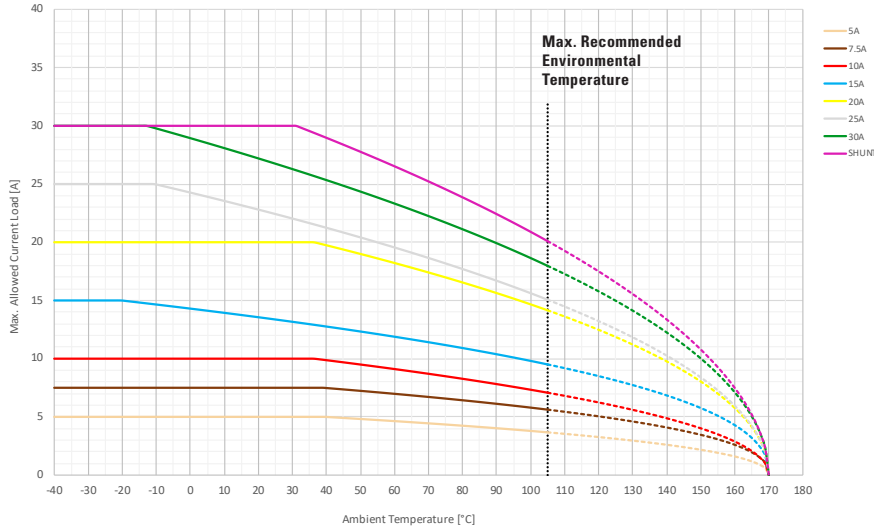

### Temperature Table

	max. allowed current load [A] at ambient temperature (typical derating)						
	-40°C	0°C	20°C	65°C	85°C	110°C	125°C
<b>5A</b>	5	5	5	5	4	4	3
<b>7.5A</b>	7.5	8	8	7	6	5	5
<b>10A</b>	10	10	10	9	8	7	6
<b>15A</b>	15	14	14	12	11	9	8
<b>20A</b>	20	20	20	18	16	14	12
<b>25A</b>	25	24	23	19	17	14	13
<b>30A</b>	30	29	27	23	21	17	15
<b>SHUNT</b>	30	30	30	26	23	19	17

### Soldering Parameters

<b>Pre Heat</b>	Temperature Min ( $T_s$ min)	150 °C
	Temperature Max ( $T_s$ max)	200 °C
	Time (min to max) ( $t_s$ )	40 - 80 secs
<b>Reflow</b>	Temperature ( $T_L$ ) (Liquidus)	220 °C
	Time ( $t_L$ )	45 - 90 secs
<b>Peak Temperature (<math>T_p</math>)</b>		235 - 250 °C
<b>Ramp-down Rate</b>		< 2.5 °C / Sec
<b>Do not exceed</b>		260 °C

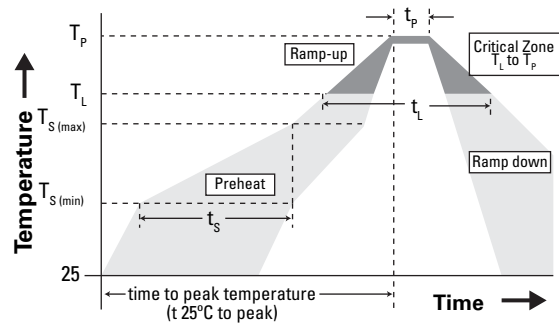

### Packaging

Packaging Option	Package Specification	Quantity	Quantity & Packaging Code
16mm Tape and Reel	EIA-481	1000 pcs per reel	MR



## CABLE/PAL FUSES

---

BF-Inline Fuses Rated 32V	75
CABLEPRO® Cable Protector Fuses Rated 32V	76
PAL Fuses	77





## BF-Inline Fuse Rated 32V

Inline fuse to protect specific cable cross-sections and insulations; Cross-section 10mm<sup>2</sup> to 35mm<sup>2</sup>. For rated voltage up to 32 VDC.

Assembly notes: The wire integrated fuse has to be insulated by using a self-adhesive shrinking tube. The wire has to be fixed on both sides of the fuse to minimize the wire forces. Recommended shrinking tube: DERAY(R)-IAKT 4:1, 24mm

### Specifications

Voltage Rating:	32 VDC
Housing Material:	PETGF30
Insulating Housing Material:	PAGF30
Terminals:	Crimp, Copper alloy, tinned
Interrupting Rating:	2000A @32VDC

### Ordering Information

Part Number	Package Size
153.0000	300

### Time-Current Characteristics 100A-190A

% of Rating	Opening Time Min / Max (s)	
100	360,000 s	—
150	90 s	1800 s
200	3 s	240 s
300	0.3 s	60 s
500	0.1 s	10 s

### Time-Current Characteristics 300A

% of Rating	Opening Time Min / Max (s)	
75	360,000 s	—
165	10 s	100 s
200	1 s	15 s
350	0.3 s	5 s
500	0.1 s	1 s

### Ratings

Part Number	Current Rating (A)	Wire Size/Type/Marking	Typ. Voltage Drop (mV)	Cold Resistance (mΩ)	I <sup>2</sup> t (A <sup>2</sup> s)
153.1002	100	10mm <sup>2</sup> /FLY/P	60	0.42	27,000
153.1012	125	10mm <sup>2</sup> /FL2G/S	70	0.32	87,500
153.1602	125	16mm <sup>2</sup> /FLY/P	75	0.41	29,600
153.1612	170	16mm <sup>2</sup> /FL2G/S	60	0.22	248,000
153.2502	170	25mm <sup>2</sup> /FLY/P	70	0.29	78,500
153.2512	190	25mm <sup>2</sup> /FL2G/S	52	0.22	248,000
153.3502	300	35mm <sup>2</sup> /FLY/P	70	0.20	373,000

### Time-Current Characteristics Curve

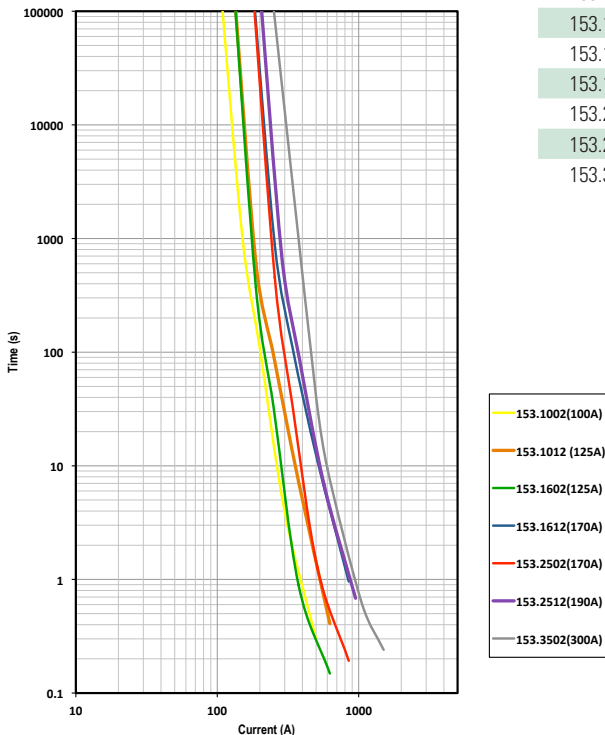



## CABLEPRO® Cable Protector Fuses Rated 32V

Available in AWG and metric cables

The CABLEPRO® fuse is designed to replace conventional wire fusible links in high current automotive applications. The slim package of the CABLEPRO® and the predictable and reliable performance characteristics (similar to MEGA® fuse) make this far superior over wire fusible links. Interrupting rating 2000A @ 32 VDC. CablePro is not a sealed product. To seal it a shrink tube should be used.

### Specifications

Voltage Rating:	32V
Interrupting rating:	2000A @ 32 VDC
Housing Material:	PPAGF33HS
Operating Temperature Range:	-40°C to +125°C
Cable Types Available:	SAE J1127 SXT, SAE J1128 TXL, ISO 6722: Type FL2G
Operating Temperature Range:	-40°C to +150°C - Optional for 150A, 175A and 200A ratings
Cable Type:	Thin wall irradiated XLPE (SAE 4GA)

Available with UL recognized in 60, 100, 150 & 200 at 32V  
(UL not available with the thin wall irradiated XLPE SAE 4GA cable)

**RoHS**

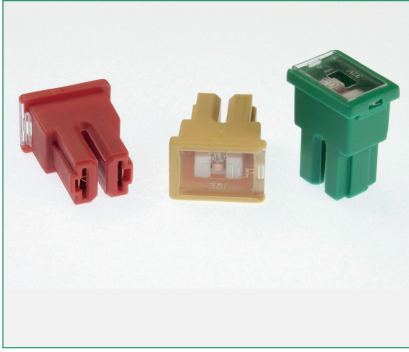

### 293 Series

Auto Link PAL 293 Series Fuse  
Amps (A): 20, 30, 40, 50, 60, 70, 80, 100

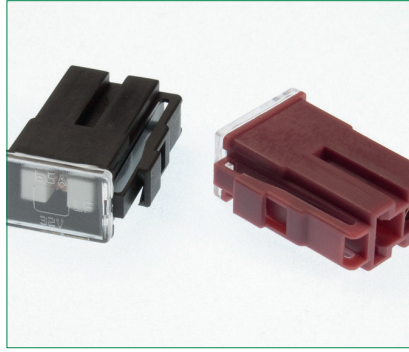

### 2935 Series

Auto Link PAL 2935 Series Fuse  
Amps (A): 25, 30, 45, 65, 75

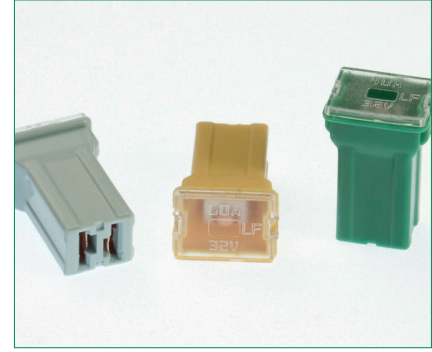

### 2938 Series

Auto Link PAL 2938 Series Fuse  
Amps (A): 20, 30, 40, 50, 60, 70, 80

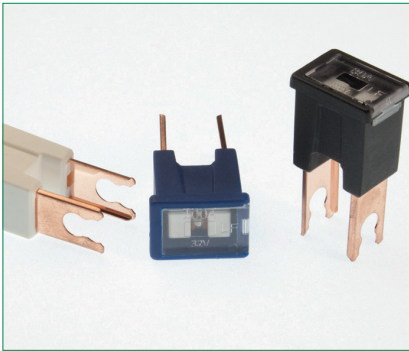

### 294 Series

Auto Link PAL 294 Series Fuse  
Amps (A): 30, 40, 50, 60, 70, 80, 100, 120

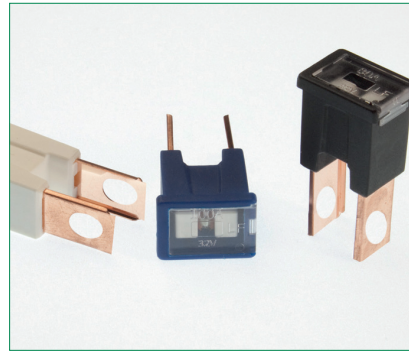

### 294C Series

Auto Link PAL 294C Series Fuse  
Amps (A): 20, 30, 40, 50, 60, 70, 80, 100, 120

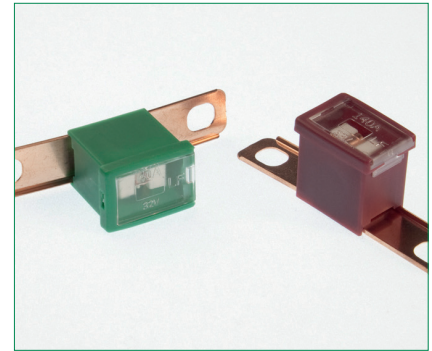

### 295 Series

Auto Link PAL 295 Series Fuse  
Amps (A): 20, 30, 40, 50, 60, 70, 80, 100, 120, 140

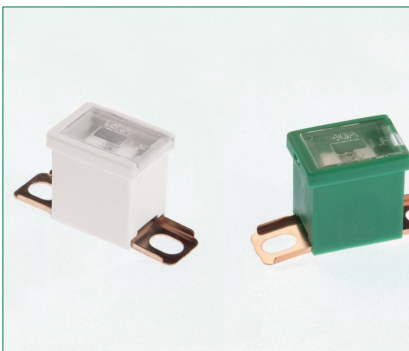

### 283B Series

Auto Link PAL 283B Series Fuse  
Amps (A): 20, 30, 40, 50, 60, 70, 80, 100, 120, 140

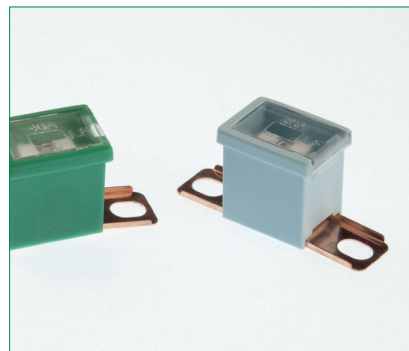

### 283 Series

Auto Link PAL 283 Series Fuse  
Amps (A): 20, 30, 40, 50, 60, 70, 80, 100, 120, 140

## HIGH VOLTAGE FUSES

---



Low Current HEV Fuses	79
Low Current High Voltage 50A Fuses	81
Low Current 10EV Fuses	83
High Current 20EV Fuses	85
High Current SHEV Fuses	86





Low Current HEV Fuses



OHEV040.ZXBD

## Low Current HEV Fuse

The LC HEV fuse is designed for protection of high-voltage accessory circuits in electric and hybrid electric vehicles.

### Specifications

Voltage Rating (10A, 15A, 20A, 30A):	450 VDC
Voltage Rating (40A):	425 VDC
Note: The OHEV040.ZXBD is rated at 450 VDC	
Interrupting Rating (10A, 15A, 20A, 30A):	10kA @ 450 VDC
Interrupting Rating (40A):	10kA @ 425 VDC
Operating Temperature Range:	-40°C to +125°C

### Ordering Information

Part Number	Termination	Package Size	% of Rating	Opening Time Min / Max (s) 10A	Opening Time Min / Max (s) 15A, 20A, 30A	Opening Time Min / Max (s) 40A
OHEVxxx.ZXC	Cartridge	240				
OHEVxxx.ZXISO	Bolt Down (ISO)	240	100	100 hrs / -	100 hrs / -	100 hrs / -
OHEVxxx.ZXPY	Blade	240	110	4 hrs / -	4 hrs / -	-
OHEVxxx.ZXBD	Bolt Down (Axial)	240	135	100 / 3600	150 / 3600	150 / 3600
OHEVxxx.ZXPCB	PCB Mount	240	150	10 / 1000	10 / 1000	10 / 1000
OHEVxxx.ZXPCBL	PCB Mount (Long)	240	200	0.5 / 100	0.5 / 100	0.5 / 100
			300	0.1 / 15	0.1 / 15	0.1 / 15
			500	0.05 / 1	0.05 / 1	0.05 / 1

### Time-Current Characteristics

### Ratings

Part Number	Current Rating (A)	Color Code	Typical Voltage Drop at 70% I <sub>R</sub> (mV)	Maximum Voltage Drop Spec at 100% IR (mV)	Typical Cold Resistance (mΩ)	Minimum Melting I <sup>2</sup> t (A <sup>2</sup> s)
OHEV010.xxx	10	Red	114	300	12.8	255
OHEV015.xxx	15	Blue	96	200	7.9	133
OHEV020.xxx	20	Yellow	79	200	5.0	268
OHEV030.xxx	30	Green	67	200	2.7	993
OHEV040.xxx	40	Orange	69	200	2.0	1495

(Average Initial Measurements)

### Time-Current Characteristic Curves

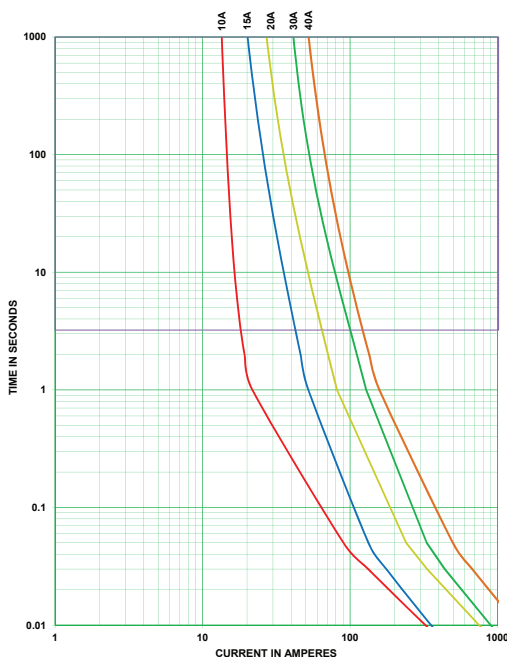

### Temperature Derating Curve

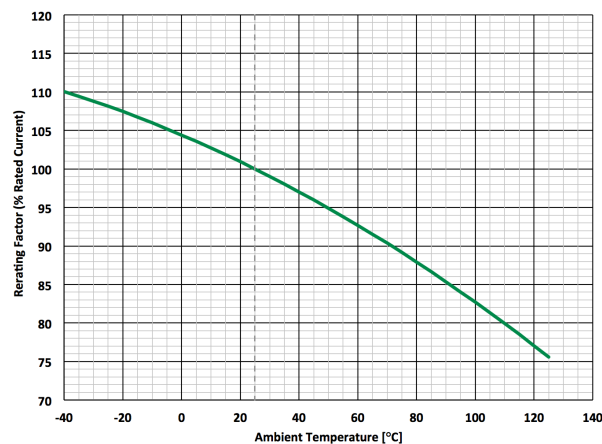

## Low Current HEV Fuse

### Dimensions

Dimensions in mm

ZXC Cartridge

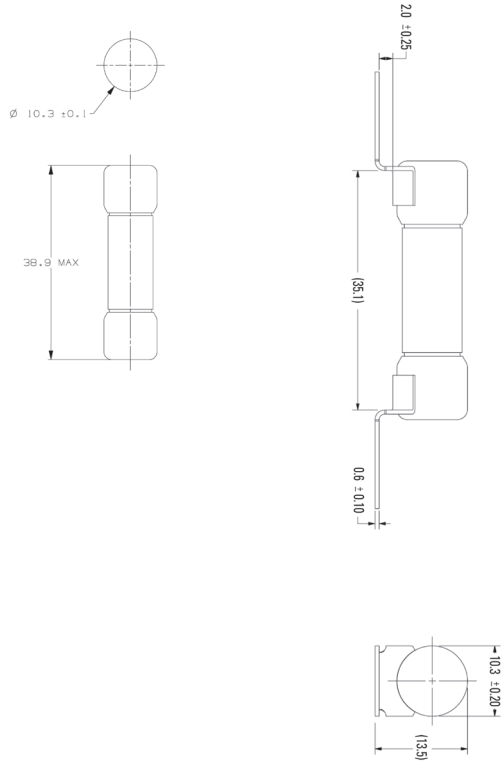

ZXISO Bolt Down (ISO)

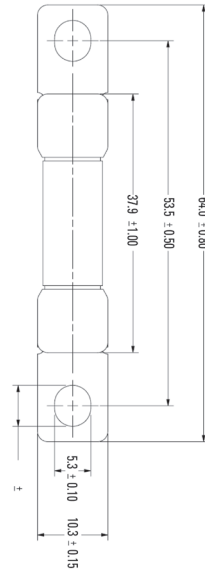

ZXPY Blade

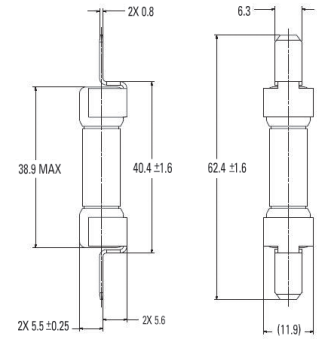

ZXBD Bolt Down (Axial)

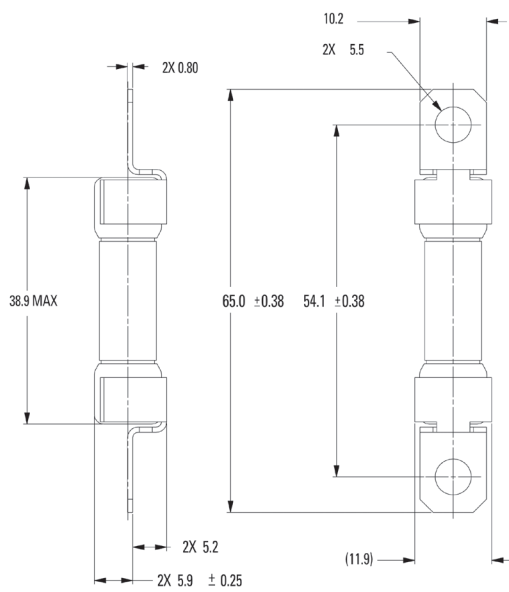

ZXPCB PCB Mount

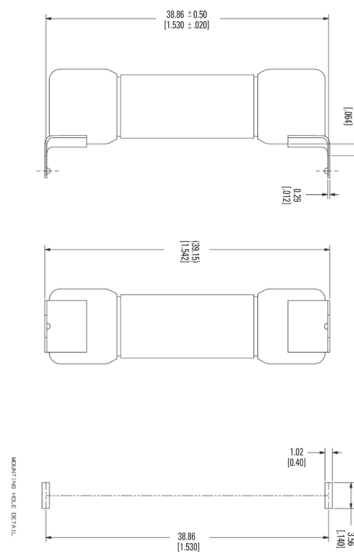

ZXPCBL PCB Mount (Long)

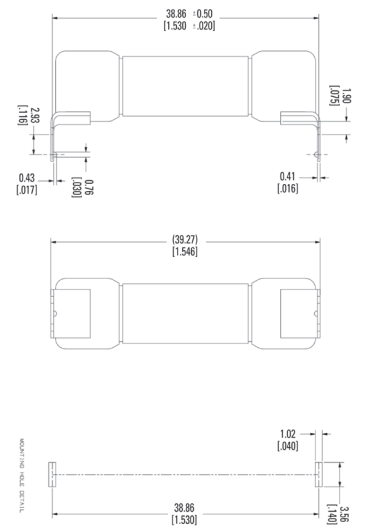



Low Current  
High Voltage 50A Fuses

## Low Current High Voltage 50A Fuse

The LC HEV fuse is designed for protection of high-voltage accessory circuits in electric and hybrid electric vehicles.

### Specifications

Voltage Rating (50A): 275 VAC  
 Interrupting Rating (50A): 10,000A @ 275 VAC  
 Operating Temperature Range: -40°C to +125°C

### Ordering Information

Part Number	Termination	Package Size
OHEVxxx.ZXC2	Cartridge	240
OHEVxxx.ZXIS02	Bolt Down (ISO)	240
OHEVxxx.ZXP2Y	Blade	240
OHEVxxx.ZXPCB2	PCB Mount	240
OHEVxxx.ZXPCBL2	PCB Mount (Long)	240
OHEVxxx.ZXBD2	Bolt Down (Axial)	240

### Time-Current Characteristics

% of Rating	Opening Time Min / Max (s)
100	100 hrs / -
110	4 hrs / -
135	-
150	-
200	0.5 / 100
300	0.1 / 15
500	0.05 / 1

### Ratings

Part Number	Current Rating (A)	Voltage Rating (VAC)	Color Code	Typical Voltage Drop at 70% I <sub>R</sub> (mV)	Maximum Voltage Drop Spec at 100% I <sub>R</sub> (mV)	Typical Cold Resistance (mΩ)	Minimum Melting I <sup>2</sup> t (A <sup>2</sup> s)
OHEV050.XXX	50	275	White	57	200	1.2	1495

### Time-Current Characteristic Curves

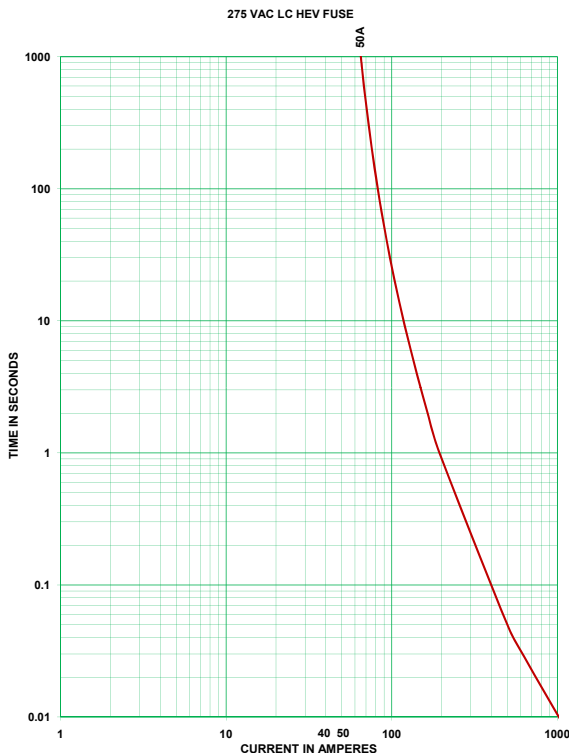

### Temperature Derating Curve

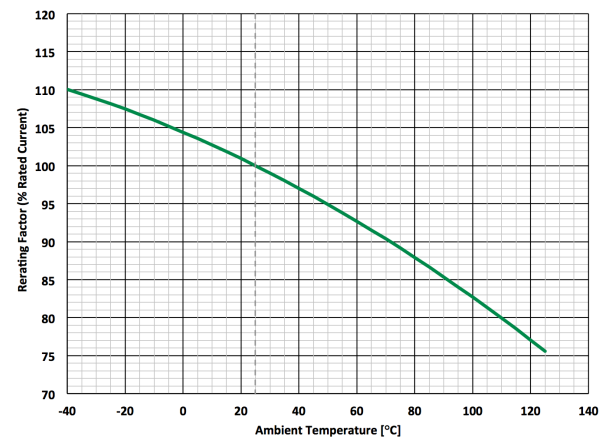

## Low Current High Voltage 50A Fuse

### Dimensions

Dimensions in mm

ZXC2 Cartridge

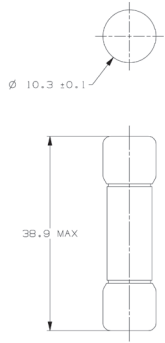

ZXIS02 Bolt Down (ISO)

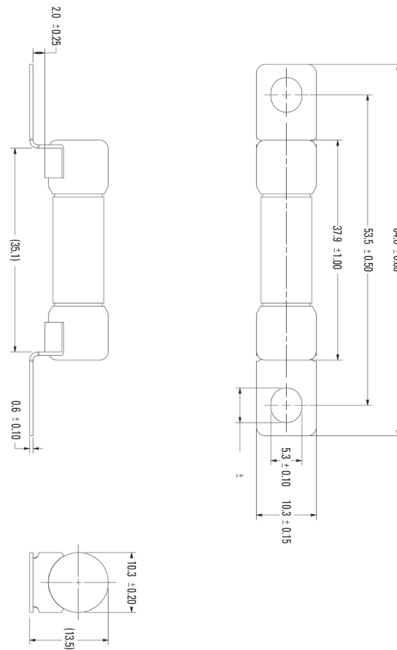

ZXP2Y Blade

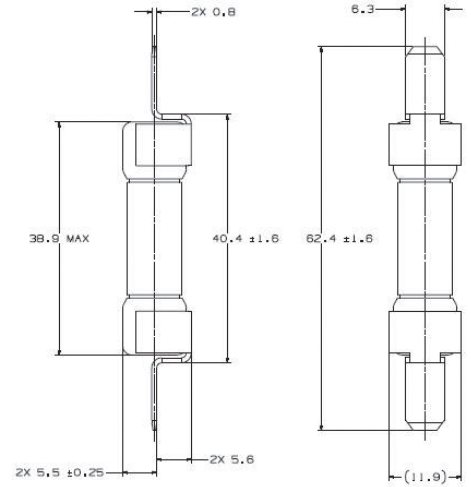

ZXPCB2 PCB Mount

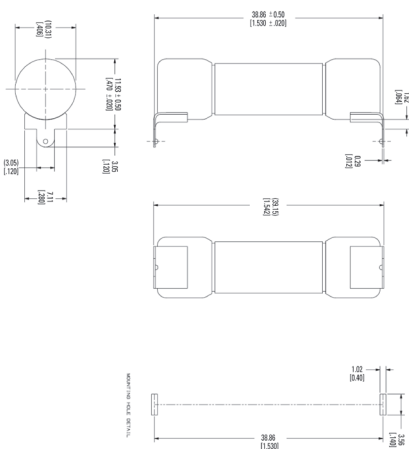

ZXPCBL2 PCB Mount (Long)

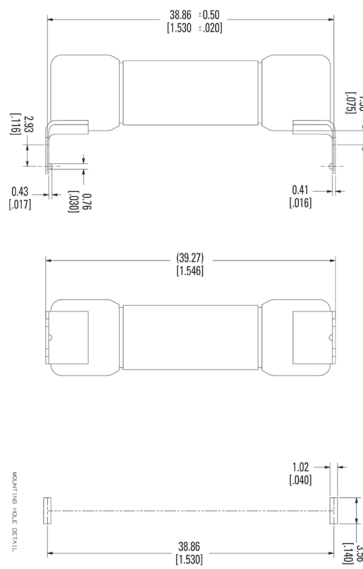

ZXBD2 Bolt Down (Axial)

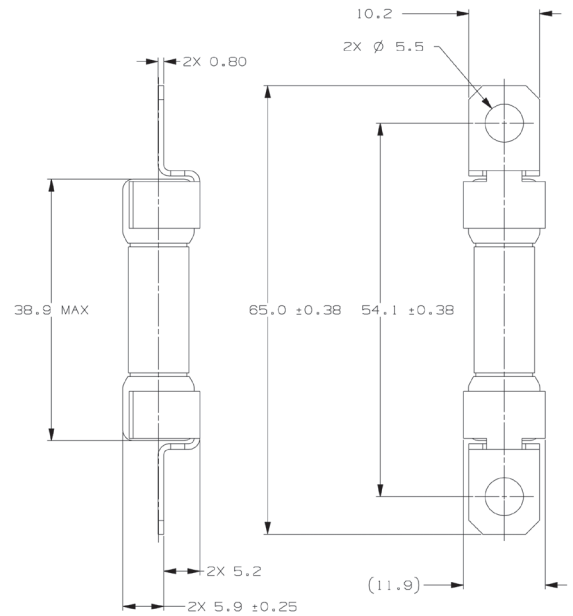





10EV Fuses

## Low Current 10EV Fuse

The 10EV fuse is designed for protection of high-voltage accessory circuits in electric and hybrid electric vehicles.

### Specifications

Voltage Rating:	500 VDC/VAC
Interrupting Rating:	20kA @ 500VDC/VAC
Operating Temperature Range:	-40°C to +125°C
Material:	Body - Melamine (U.L. 94 Flammability rating - V-0) End Caps - Brass / Nickel Plated Terminals - Copper Alloy / Tin Plated (Nickel for ZXISO and ZXB DP version only)
Recommended Mounting Torque:	4,5 ±1 Nm M5 (ISO prescription for ZXISO and ZXB DP version)
Refers To:	ISO 8820-8 JASO D622

## Time-Current Characteristic Curves

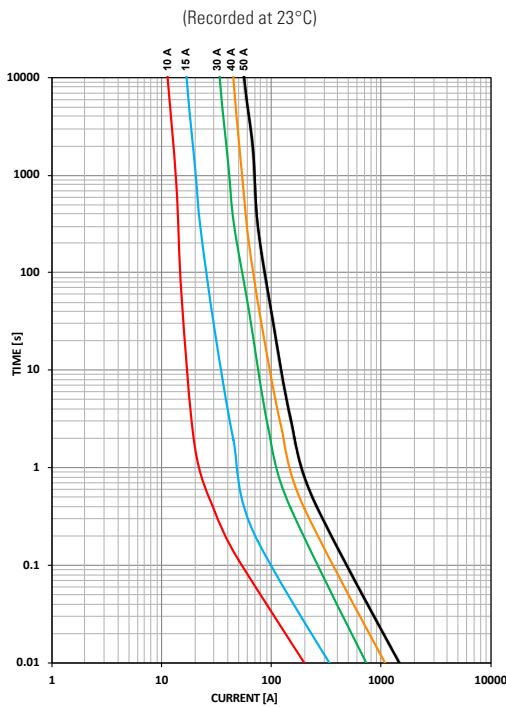

## Ordering Information

Weight ±10% (g)	Part Number	Termination	Package Qty
7.8	10EVxxx.ZXC	Cartridge	320
10	10EVxxx.ZXISO	Bolt Down (ISO)	320
11.6	10EVxxx.ZXPY	Blade	320
10.8	10EVxxx.ZXB DP	Bolt Down (Axial)	320
8.2	10EVxxx.ZXPCB	PCB Mount	320
8.3	10EVxxx.ZXPCBL	PCB Mount (Long)	320

## Time-Current Characteristics

% of Rating	Opening Time Min / Max (s)
110	4 hrs / ∞
135	150 / 3600
150	10 / 1000
200	0.5 / 100
300	0.1 / 15
500	0.05 / 1

## Ratings

Part Number	Current Rating (A)	Color Code	Typical Voltage Drop at 70% I <sub>R</sub> (mV)	Maximum Voltage Drop Spec at 100% IR (mV)	Test Cable Size (mm <sup>2</sup> )	Typical Cold Resistance (mΩ)	Typical Melting I <sup>2</sup> t (A <sup>2</sup> s)
10EV010.xxx	10	Red	114	300	1	12.8	316
10EV015.xxx	15	Blue	83	200	1.5	7.4	803
10EV020.xxx	20 (*)	Yellow	Coming up	200	2.5	Coming up	Coming up
10EV030.xxx	30	Green	67	200	5	3	1527
10EV040.xxx	40	Orange	69	200	5	2.1	4450
10EV050.xxx	50	Black	74	200	5	1.3	7803

Final values for voltage drop, resistance, melting I<sup>2</sup>t and T/C curves will be generated from PV tests data  
 (\*) Products in development - please contact Littelfuse® for more details regarding availability timing.

## Low Current 10EV Fuse

### Dimensions

Dimensions in mm

ZXC Cartridge

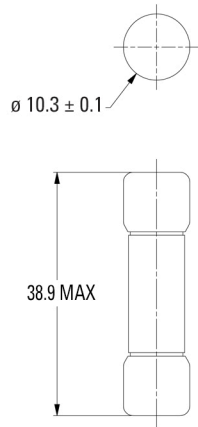

ZXISO Bolt Down (ISO)

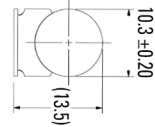
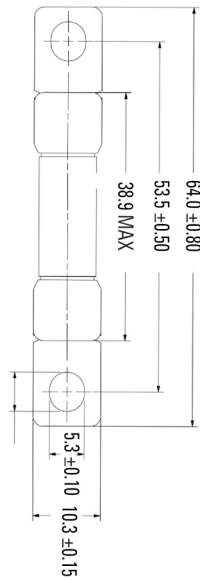
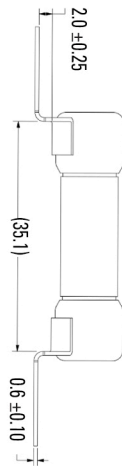

ZXPY Blade

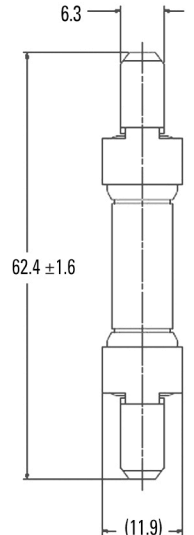
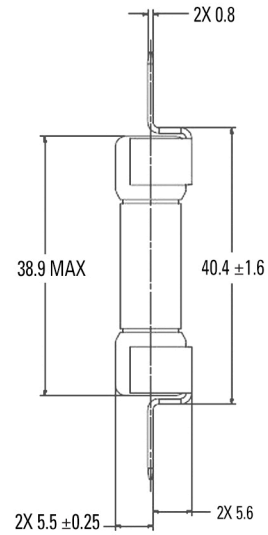

ZXBDP Bolt Down (Axial)

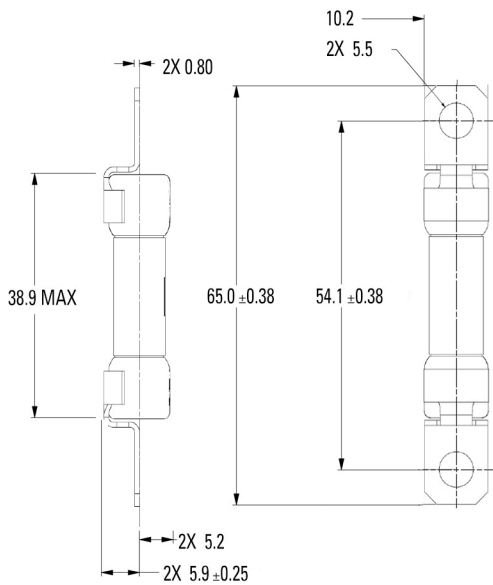

ZXPCB PCB Mount

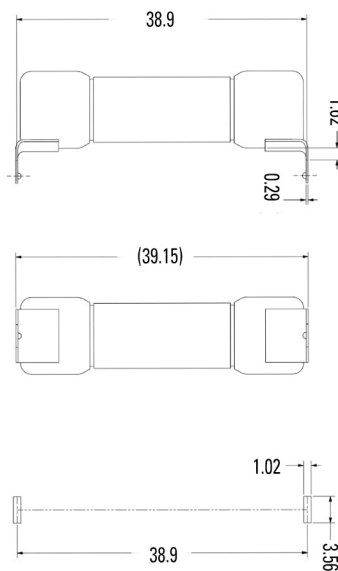

ZXPCBL PCB Mount (Long)

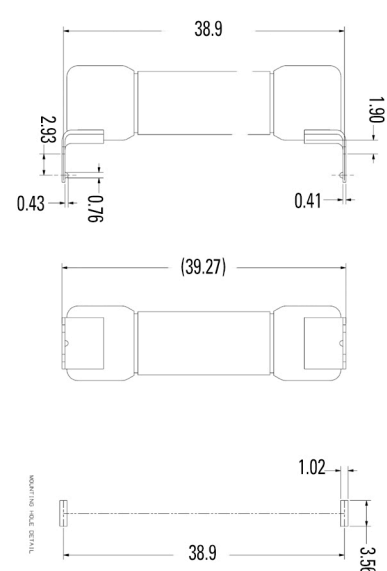



High Current 20EV Fuses

## High Current 20EV Fuse

The HC EV fuse is designed for protection of high-current / high-voltage circuits in electric and hybrid electric vehicles.

### Specifications

Interrupting Rating:	20kA @ 500VDC
Voltage Rating:	500VDC
Operating Temperature Range:	-40°C to +125°C
Net Weight Per Fuse:	35±5 gr
Material:	Body: Melamine (U.L. 94 Flammability rating – V0) Retaining Pins: Stainless Steel Endbells: Zinc Alloy Terminals: Copper Alloy
Mounting Torque:	5-7 Nm M6 (ISO prescription) 10 Nm M6 (Max allowed)
Refers To:	ISO 8820-8 JASO D622

### Ordering Information

Part Number	Termination	Package Size
20EVxxx.ZXBDM	M6 Bolt Down	320

### Time-Current Characteristics

% of Rating	Opening Time Min / Max (s)
110	4 hrs / ∞
200	1.0 / 300
300	0.2 / 30
500	0.05 / 1.0

### Time-Current Characteristic Curves

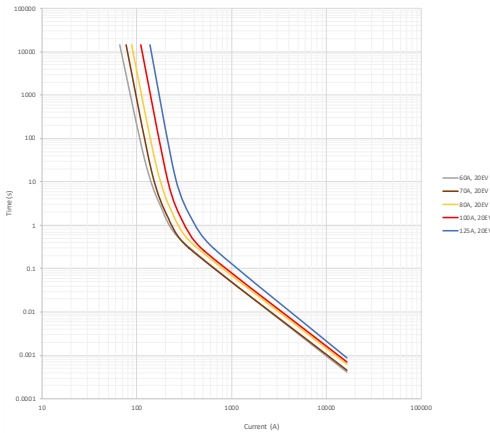

### Ratings

Part Number	Current Rating (A)	Typ. Voltage Drop (mV)	Max. Voltage Drop Spec at 100% IR (mV)	Test Cable Size (mm²)	Typical Cold Resistance (mΩ)	Typical Melting I²t (A²s)
20EV060.ZXBDM	60	137	200	5	1.70	6539
20EV070.ZXBDM	70	142	200	10	1.43	8459
20EV080.ZXBDM	80	145	200	10	1.25	17836
20EV100.ZXBDM	100	132	200	20	0.83	22215
20EV125.ZXBDM	125	160	200	20	0.69	33856

(Average Initial Measurements)

## High Current 20EV Fuse

### Dimensions

Dimensions in mm

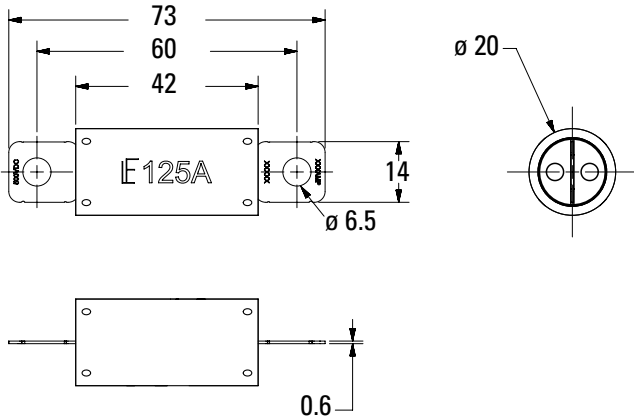

### Temperature Table

	max. allowed current load [A] at ambient temperature (typical derating)						
	-40°C	0°C	20°C	65°C	85°C	110°C	125°C
<b>60A</b>	60	57	55	48	45	41	38
<b>70A</b>	70	70	68	60	56	51	48
<b>80A</b>	80	80	80	72	67	61	56
<b>100A</b>	100	100	100	92	87	79	74
<b>125A</b>	123	114	109	98	92	84	79

### Typical Derating Of Fuse Melting Element

Temperature Security Margin is 20%

Please Contact Littelfuse® For Details Regarding Derating Test Set Up

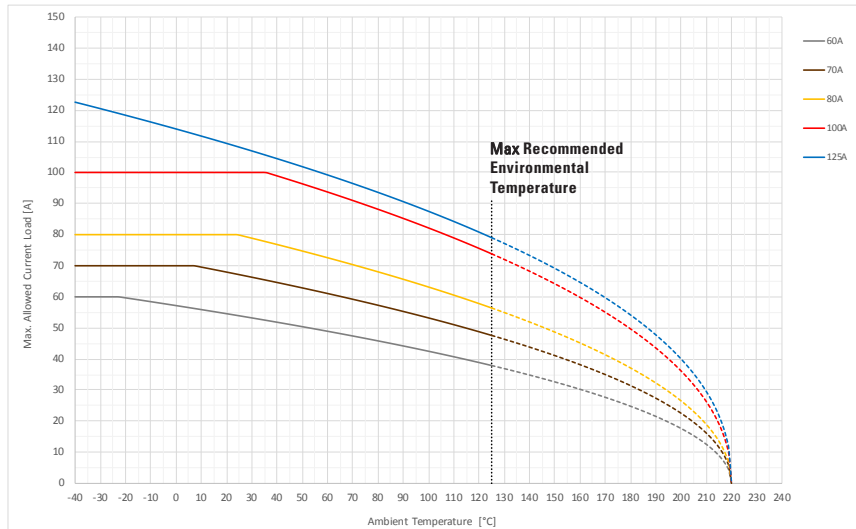

Derating curves may change depending on the final condition of the application (terminals characteristics, wire size exc..). Please ask Littelfuse for more information.



High Current SHEV Fuses

## High Current SHEV Fuse

The HC HEV fuse is designed for protection of high-current / high-voltage circuits in electric and hybrid electric vehicles employing an industry-standard footprint. The HC HEV fuse provides time-delay characteristics with "Diffusion Pill Technology."

### Specifications

Interrupting Rating:	10KA @ 450VDC
Voltage Rating:	450VDC
Operating Temperature Range:	-40°C to +125°C
Net Weight Per Fuse:	30±5 gr
Material:	Body: Melamine (U.L. 94 Flammability rating – V0) End Caps: Stainless Steel Terminals: Copper Alloy
Recommended Mounting Torque:	5-7 Nm M6 (ISO prescription) 10 Nm M6 (Max allowed)
Refers To:	ISO 8820-8 first edition 2012-08-01 (Type J2) - JASO D622

### Ordering Information

Part Number	Termination	Package Size
SHEVxxx.ZXBD	M6 Bolt Down	320

### Time-Current Characteristics

% of Rating	Opening Time Min / Max (s)
110	4 hrs / ∞
200	1.0 / 300
300	0.2 / 30
500	0.05 / 1.0

### Time-Current Characteristic Curves

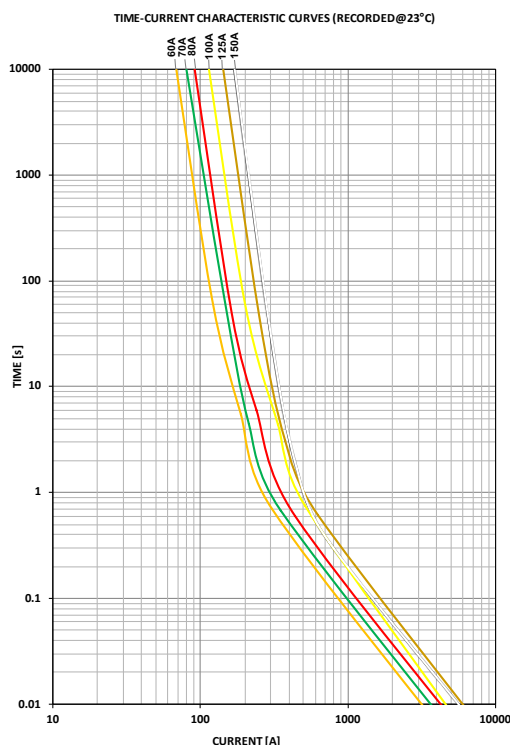

### Ratings

Part Number	Current Rating (A)	Typ. Voltage Drop (mV)	Max. Voltage Drop Spec at 100% IR (mV)	Cold Resistance (mΩ)	Minimum Melting I <sup>2</sup> t (A <sup>2</sup> s)
SHEV060.ZXBD	60	110	200	1.4	7745
SHEV070.ZXBD	70 (*)	115	200	1.2	Coming up
SHEV080.ZXBD	80	90	200	0.8	16002
SHEV100.ZXBD	100	95	200	0.62	27079
SHEV125.ZXBD	125 (*)	95	200	0.48	Coming up
SHEV150.ZXBD	150 (*)	140	200	0.48	Coming up

(\*) Products in development - please contact Littelfuse® for more details regarding availability timing. Final values for voltage drop, resistance, melting I<sup>2</sup>t and T/C curves will be generated from PV tests data.

### Dimensions

Dimensions in mm

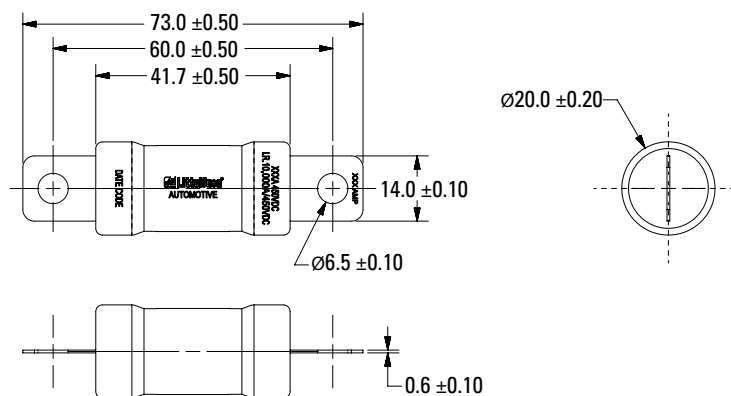



## SPECIALTY PRODUCTS

---

Shunts	88
Diodes/Resistors	89



## ATO<sup>®</sup> Shunt

### Specifications

Recommended Environmental Temp\*: -40°C to +125°C  
 Maximum Continuous Load Rating: 35A\*\*  
 Housing Material: Thermoplastic (UL 94 Flammability Rating V0)  
 Terminal Material: Tin Plated Brass

\*Tin plating's temperature limit is ~130°C

\*\*Rating varies based on mating terminal performance

Part Number	Max Continuous Load Rating* (A)	Housing Material	Terminal Material	Part Quantity
02400094P	35	Thermoplastic (UL 94V0)	Tin Plated Brass	2000



ATO® Diode

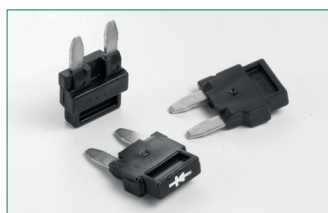

MINI® Diode

## ATO® / MINI® Diodes

### Specifications

Operating Temp.:	-40°C to +125°C
Power Rating:	¼ W Max
Housing Material:	Thermoplastic
Term. Material:	C.R.S. (Ni/Zn Plated)
Term. Retention:	25 N

### Ratings

Part Number	Current Rating (A)	Type	Housing Material Color	Peak Inverse Voltage (Volts)	Part Quantity
02400103_	1	ATO	Black	400	Z = 1500 / LXN = 50
02400113P	1	MINI	Black	400	2000
02400115P	1	MINI	Green	1000	2000
02400120P	1.5	MINI	Brown	400	2000

\* 1 A Diode in ATO® size housing. The cathode connector is rotated 90°



ATO® Resistor



MINI® Resistor

## ATO® / MINI® Resistors

### Specifications

Housing Material:	Thermoplastic
Term. Material:	C.R.S. (Ni/Zn Plated)
Term. Retention:	25 N

### ATO® Resistor

Operating Temp.:	-20°C to +125°C
Power Rating:	1/4 W Max

### MINI® Resistor

Operating Temp.:	-40°C to +125°C
Power Rating:	up to 1/2 W

Part Number	Type	Resistance (ohm)	Wattage (Watt)	Housing Material Color	Part Quantity
02400105Z	ATO	10K	¼	White	1500
02400106P	MINI	620	½	Grey	2000
02400107P	MINI	121	½	Grey	2000
02400108P	MINI	5.1K	¼	Blue	2000
02400111P	MINI	16.9	¼	Red	2000
02400112P	MINI	121	½	Green	2000
02400118P	MINI	500	½	Grey	2000





# FUSEOLOGY

## I. Introduction

The purpose of this Fuseology section is to promote a better understanding of fuses and some of the more common application details. The fuses to be considered are current-sensitive devices which are designed as the intentional weak link in the electrical circuit. The function of a fuse is to provide discrete component or complete circuit protection by reliably melting under overcurrent conditions and thus safely interrupting the flow of current.

## II. Types of Overcurrents

An overcurrent is any current which exceeds the ampere rating of wiring, equipment or devices under conditions of use. The term "overcurrent" includes both overloads and short circuits.

### A. Overloads

An overload is an overcurrent which is confined to normal current paths. An overload occurs when the current exceeds the value for which the wires or equipment are rated. This can happen when too many devices are connected to the circuit, or when a device connected to the circuit malfunctions in a way that causes it to draw higher than normal current, usually in the range of one to six times normal current. Sustained overloads eventually overheat circuit components. Therefore, fuses must open circuits experiencing sustained overloads before damage occurs.

### B. Short Circuits

A short circuit is current out of its normal path. It occurs when accident or malfunction creates an unintended path for the electricity to flow from the battery or alternator to ground. This shorter, more direct path to ground bypasses the resistance normally offered by the wiring and devices connected to the circuit. With virtually no resistance left to impede current flow, the voltage forces higher and higher current to flow through the wires to the point of the short. Under such a condition, the current will quickly build to such a high level that the heat generated can cause insulation to burn and equipment to be damaged unless the circuit is opened through the use of a fuse.

## III. Fuse Selection Parameters

Since overcurrent protection is crucial to reliable electrical system operation and safety, fuse selection and application should be carefully considered. When selecting fuses, the following parameters should be evaluated:

### A. Voltage Rating

The voltage rating, as marked on a fuse, indicates the maximum voltage of the circuit for which the fuse is designed to operate safely in the event of an overcurrent. Therefore, the fuse's voltage rating must equal or exceed the available circuit voltage where the fuse will be installed. System voltage exceeding the fuse's rated voltage may result in fuse damage. The voltage rating is 32 volts DC for the MINI®, MAXI®, ATO®, MIDI®, MEGA®, and CABLEPRO® Fuses.

### B. Interrupting Rating

The interrupting rating (also known as breaking capacity or short circuit rating) is the maximum current, as stated by the manufacturer, which the fuse can safely interrupt at rated voltage. During a fault or short circuit condition, a fuse may receive an instantaneous current many times greater than its normal operating current. Safe operation requires that the fuse remain intact (no body rupture) and clear the circuit. The interrupting rating is 1000A @ 32 volts DC for the MINI®, MAXI®, ATO®, JCASE®, and MIDI® Fuses, and 2000A @ 32 volts DC for the MEGA® and CABLEPRO® Fuses.

### C. Time-Current Characteristics

A fuse's time-current characteristics determine how fast it responds to different overcurrents. All fuses have inverse time-current characteristics, so opening time decreases as overcurrents increase. Time-current characteristics are presented graphically on standardized "log-log" paper. Figure 1 is a sample time-current curve for the MAXI Fuse series for fuses rated 20-60A. Current values increase from left to right, and time increases from bottom to top. The average melting time for any current can be determined from the curve. For example, from Figure 1 it can be determined that a 20A MAXI Fuse experiencing an overload of 100A will open in about 0.5 seconds. At 40A, the same 20A MAXI Fuse would open in about 9 seconds.

Time-current curves are also used to compare fuses of the same series but of different current ratings. Suppose it was desired to compare the opening times of 20A and 60A MAXI Fuses at an overload of 100A. From the curve in Figure 1, one can see that the 20A fuse opens in about 0.5 seconds at 100 amps, whereas the 60A fuse does not open until about 50 seconds.

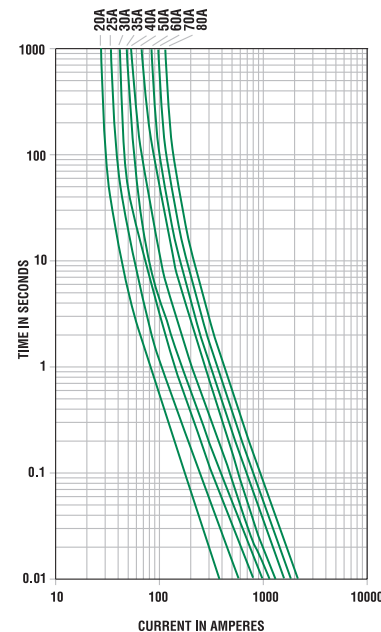

Figure 1: Average Melting-Current Curve for the MAXI Fuse Series (20-60A)

It is important to note that time-current curves give only average melting times and are presented as a design aid but are not considered as part of the fuse specifications.

The term used in fuse design that describes how rapidly a fuse responds to various overcurrents is the fuse's "characteristics." Automotive fuse characteristics are determined by the fuse's degree of time delay. Initial or start-up pulses are normal for many automotive applications and require fuses to have a time delay designed in to enable them to survive these pulses and still provide protection against prolonged overloads. Fuses such as the MINI® Fuse and ATO® Fuse have a moderate degree of time delay, whereas fuses like the MAXI® Fuse and MEGA® Fuse have a high degree of time delay which enables them to handle high inrush currents like those caused by motor start-ups. Figure 2 compares sample time-current curves of a 30A MINI Fuse to a 30A MAXI Fuse. To see that the MAXI Fuse has more time delay than the MINI Fuse, compare their opening times at an overload of 100A. Despite the fact that the fuses are the same rating, the MINI Fuse opens in about 0.1 seconds while the MAXI Fuse opens in about 2.2 seconds.

When selecting a fuse, the start-up pulse should be defined and then compared to the time-current curve for the fuse.

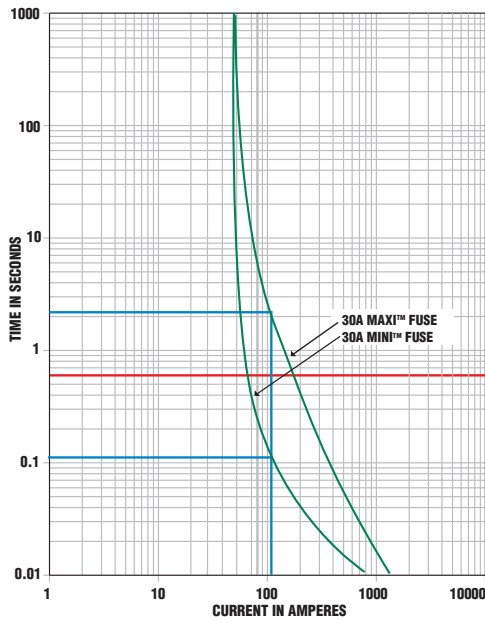

Figure 2: Average Melting-Current Curve Comparing 30A MINI Fuse to 30A MAXI Fuse

## D. Current Rating

The current rating is the maximum current which the fuse can continuously carry under specified conditions.

### 1. Normal Operating Current Based On Rerating

#### 1.1 At Room Temperature

The current rating of a fuse is typically derated 25% for operation at 25°C to avoid nuisance blowing. This means that the new current carrying capability of the fuse is equal to 75% of its rating.

For example, a fuse with a current rating of 10A is not usually recommended for operation at more than 7.5A in a 25°C ambient.

#### 1.2 At a Different Ambient Temperature

The Rerating curve is based on a voltage drop adjustment at different ambient temperatures.

The current carrying capacity of fuses is affected by changes in ambient temperature.

At higher ambient temperatures, a fuse will respond faster to a given overload. Conversely, at lower ambient temperatures, a fuse will respond slower to a given overload. In addition, the temperature of the fuse increases as the normal operating current approaches or exceeds the rating of the fuse.

Figure 3 is the temperature rerating curve for the MAXI® Fuse.

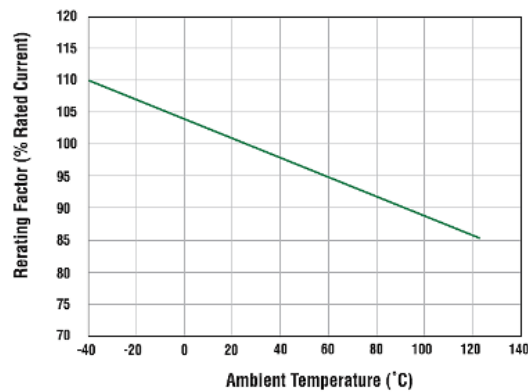

Figure 3: MAXI Temperature Rerating Curve

Suppose there is a normal operating current of 26 amperes in a particular circuit, and the ambient temperature will be 100°C instead of 25°C. Which MAXI® Fuse rating should be used? From Figure 3, the percent of rated current to be used at an ambient temperature of 100°C is 89%, so:

$$\text{Ideal Fuse Rating} = \frac{\text{Nominal Operating Current}}{\text{Temp Rerating Factor} \times 0.75}$$

$$\text{Ideal Fuse Rating} = \frac{26\text{A}}{0.89 \times 0.75} = 38.9 \text{ A}$$

Therefore, a next higher fuse rating like 40A or larger should be used.

Please review wire gauge selection at various ambient temperatures in section "IV" of fuseology guide to properly match wire gauge at highest ambient temperature.

## 2. Normal Operating Current Based On Derating

The Derating curve is based on an individual temperature rise curve.

The Derating curve defines the maximum current load that a component (typically, the fuse melting element) can continuously carry without exceeding its maximum temperature limit.

The maximum admitted temperature of a specific component is strictly correlated to the material (and the plating, if present) of the component itself and expected life time.

The derating curve is deduced from the temperature rise of the component when it is crossed by a certain current: the higher is the current, the higher is the temperature reached. This is reached as a result of the Joule effect.

Derating curve graphs are calculated with a safety temperature margin of 20%

Main characteristics of the derating curve:

- It is specific for each single fuse rating of a fuse series (MINI®, MEGA®, ZCASE®...);
- It is affected by the ambient temperature surrounding of the component;
- It is affected by the system set-up (connections, wires size etc..)

Figure 4 is an example of a Derating curve for a MAXI® 40 A fuse element.

The following example shows how to use such a curve.

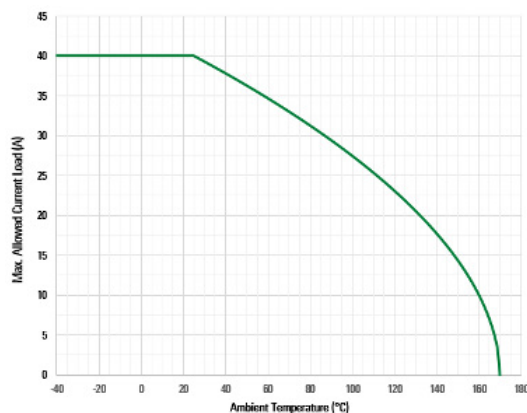

Figure 4: MAXI fuse 40 A Derating Curve

Suppose to have this fuse operating at an ambient temperature of 100 °C.

Which is the current capability of the fuse?

From Figure 4, the maximum current that the fuse can bear at 100 °C is 27.5 A.

## 3. Comparison between rerating and derating curve

Let's try to obtain the same information using both curves, considering again a MAXI® fuse 40 A and an ambient temperature of 100 °C.

In the previous point 2 we already defined that – according to the Derating Curve (Figure 4) - a MAXI® fuse 40 A can bear 27.5 A at a temperature of 100 °C.

Doing the same calculation using the Rerating curve (Figure 3), we'll obtain:

$$\text{Fuse rating} \times \text{Temp rerating factor} \times 0.75 = 40 \text{ A} \times 0.89 \times 0.75 = 26.7 \text{ A}$$

Littelfuse® recommendation is to use the rerating rule as a first and quick method to identify the most suitable fuse rating based on the current load of a specific circuit.

The Derating curve allows to have a more precise information about the maximum current capability of every single fuse\* (or any other component in the circuit) in relation to the ambient temperature.

\*Derating curves may change depending on the final condition of the application (terminals characteristics, wire size etc..). Please ask Littelfuse® for more information.

## E. Transient Overcurrent Considerations

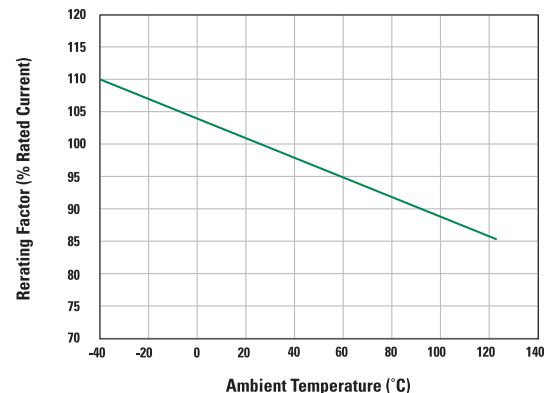

Figure 5: MINI Auto Fuse 297 Series Temperature Rerating Curve

Transient pulses of inrush current are commonplace in vehicle electrical systems. The transient overcurrent pulses affect the life of automotive fuses.

## 1. I²t

I²t is an expression of the available thermal energy resulting from current flow. With regard to fuses, the term is usually expressed as melting, arcing, and total clearing I²t. The units for I²t are expressed in ampere-squared-seconds [A²s].

**Melting I²t:** the thermal energy required to melt a specific fuse element.

**Arcing I²t:** the thermal energy passed by a fuse during the arcing time. The magnitude of arcing I²t is a function of the available voltage and stored energy in the circuit.

**Total Clearing I²t:** the thermal energy through the fuse from overcurrent inception until current is completely interrupted. Total clearing I²t = (melting I²t) + (arcing I²t).

I²t has two important applications to fuse selection. The first is pulse cycle withstand capability and the second is selective coordination.

## 2. Pulse Cycle Withstand Capability

Electrical pulses produce thermal cycling and possible mechanical fatigue that could affect the life of the fuse.

For this reason, it is important to know the pulse cycle withstand capability of the fuse, which is defined as the number of pulses of a given I²t value that can be withstood by the fuse without opening, assuming that there is sufficient cool down time between pulses.

WAVESHAPE	FUNCTION AND VALUE
<p>Square</p> 	$i = k$ $I^2t = i_c^2t$
<p>Trapezoidal</p> 	$i = i_c \pm kt$ $I^2t = (1/3)(i_c^2 + i_b i_c + i_b^2)t$
<p>Sine</p> 	$i = i_c \sin t$ $I^2t = (1/2)i_c^2t$
<p>Triangular</p> 	$i = \pm kt$ $I^2t = (1/3)i_c^2t$
<p>Second order power</p> 	$i = kt^2$ $I^2t = (1/5)i_c^2t$
<p>Natural decay to zero</p> 	$i = i_c e^{-t/\tau}$ $I^2t = (1/2)i_c^2 \tau$
<p>Natural decay to non-zero value</p> 	$I^2t = i_b^2 t - 2\tau i_b (i_c - i_b)(e^{-t/\tau} - 1) - \tau/2 (i_c - i_b)^2 (e^{-2t/\tau} - 1)$

Figure 6: Evaluating the I²t of a Variety of Current Wave Shapes

Figure 6 shows how I²t of the pulse can be calculated from the graph of the pulse current as a function of time.

Figure 7 is a graph of the pulse cycle withstand capability of blade fuses. Because electrical pulse conditions can vary considerably from one application to another, application testing is recommended to establish the ability of the fuse design to withstand the pulse condition.

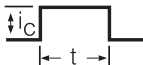
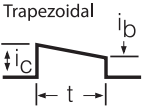
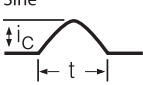
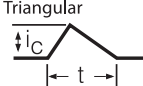
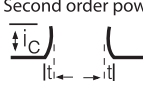
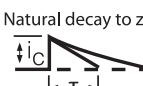
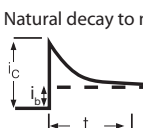
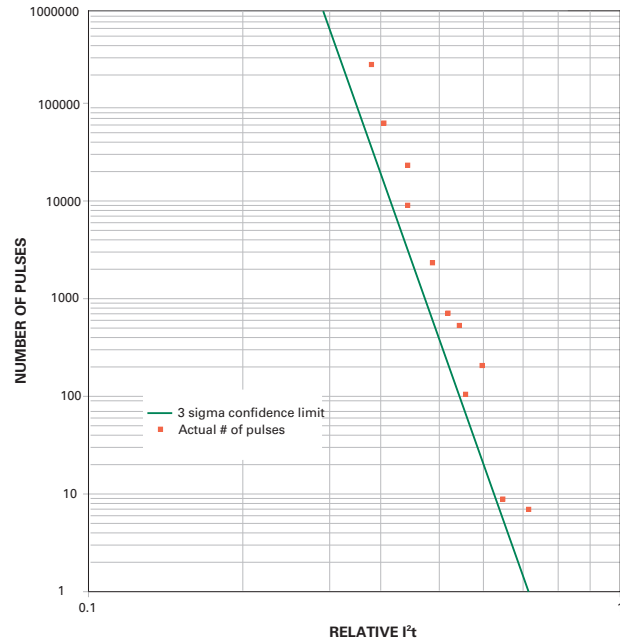

Figure 7: Pulse Cycle Withstand Capability for Blade Fuses

## 3. Selective Coordination

In a selectively coordinated system, only the fuse immediately on the line side of an overcurrent opens. Upstream fuses remain closed and undamaged. All other equipment remains in service, which simplifies locating overloaded equipment or short circuits. In Figure 8, if a short circuit arises behind fuse #1, fuse #1 should open and fuse #2 should stay closed and undamaged. The condition necessary to assure this result is that the minimum melting I²t of the supply side fuse (fuse #2) must be greater than the total clearing I²t of the load side fuse (fuse #1). This condition results in the load side fuse opening before the supply side fuse begins to melt. Minimum melting and total clearing I²t data are given in this catalog.

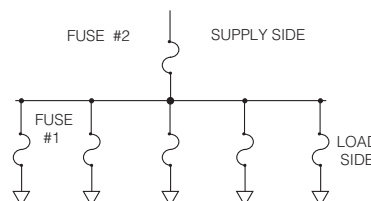

Figure 8: Selective Coordination for Fuses in Series

## IV. Voltage Drop Across Terminals

A fuse is only as good as the system in which it is used. One aspect of the electrical system that has considerable effects on the performance of the fuse is the quality of the connection between the fuse and the cable it protects. High voltage drop across the fuse/terminal interface creates additional thermal loading, which in turn causes shifts in the time-current characteristics of the fuse. Table 1 below gives the maximum recommended voltage drop per terminal for automotive fuses. Figure 9 indicates the measurement locations used to determine the voltage drop across the terminal. The voltage drop across the left terminal would be  $V_{2-4}$  and the voltage drop across the right terminal would be  $V_{1-3}$ .

Type	Maximum Recommended Voltage Drop Per Terminal [mV] (between points 1-3 or 2-4)
ATO® FUSE	30
MINI® FUSE	30
MAXI® FUSE	30
MEGA® FUSE	15

Table 1: Maximum Recommended Voltage Drop per Terminal

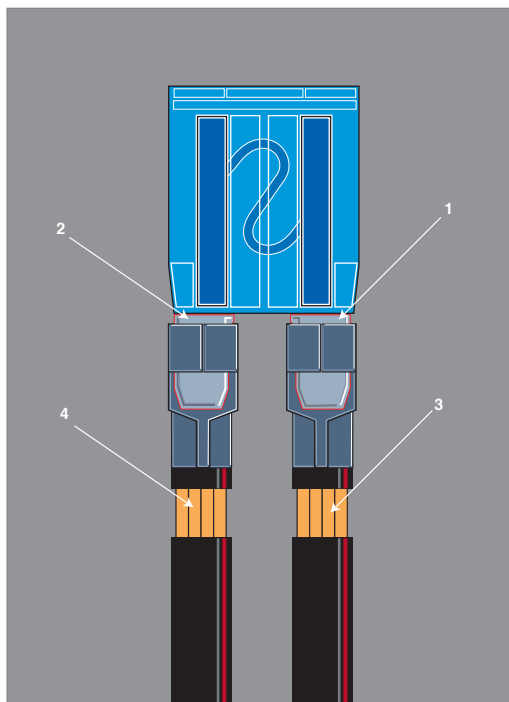

Figure 9: Measurement Locations along the Fuse/Terminal/Cable System Used to Determine the Voltage Drop across the Terminal

## V. Diffusion

Diffusion Pill Technology is a mixing of molecules, atoms or crystals in the solid, liquid or gaseous state. Diffusion Pill Technology is often used in the design of fuses for automotive, electronic and industrial fuse applications.

“M-effect” is the method of diffusing one metal into another to form a new alloy with a lower melting point. Littelfuse uses the “M-effect” to produce three very desirable characteristics in fuse designs: lower melting temperature, time delay, and lower voltage drop.

By affixing a diffusion pill tin to the element, the melting temperature is decreased. This decrease in melting temperature reduces the fuse rating. In order to reestablish its original rating the fuse elements’ cross section needs to increase. An increase in cross section increases the blow time at higher overload condition. A higher degree of time delay enables a fuse to withstand higher current inrush pulses. This increase in cross section reduces the overall fuse resistance and voltage drop.

## VI. Match Wire Gauge to Fuse

In order to protect wiring under all overload and short circuit conditions, it is necessary to standardize the fuse and wire selection process.

Fuses have controlled opening characteristics, and each wire gauge has its respective current carrying capacity. Fuses need to be selected to always protect the wire insulation from damage.

In the selection of wire gauge at various ambient temperatures, it is important to consider the worst case or highest ambient temperature for the application. Wires derate to a much higher degree than fuses, because wire insulation temperature capability is affected much more severely.

### Maximum Recommended Continuous Current

Wire Size		Max Continuous Current (A)				
		At 25°C		At 80°C		At 105°C
mm <sup>2</sup>	Gage No.	GXL (1)	GPT (2)	GXL (1)	GPT (2)	GXL (1)
0.3		15	10	11	4	9
0.5	20	21	15	16	6	13
0.75		27	21	20	7	17
0.8	18	31	22	23	7	19
1	16	33	23	25	9	20
1.5		43	30	33	12	27
2	14	50	36	37	14	32
2.5		60	42	45	15	38
3	12	68	47	51	18	42
4		80	56	61	22	50
5	10	90	65	68	23	58
6		103	73	78	28	64
8	8	125	87	96	30	79
10		146	103	111	40	90
13	6	170	120	129	47	105
19	4	221	156	166	61	137

(1) = General purpose cross link polyethylene insulation wire with a maximum insulation temperature of 155°C.

(2) = General purpose thermoplastic insulation wire with a maximum insulation temperature of 90°C.





# Littelfuse®

English ▾

Find a Distributor

Search All



Search by Keyword

Expertise Applied | Answers Delivered

PRODUCTS

INDUSTRIES

SERVICES

TECHNICAL RESOURCES

Competitor Cross References

Home > Products > Fuses > Passenger Car and Commercial Vehicle

## Passenger Car and Commercial Vehicle

**To assist you with your design and selection processes, Littelfuse also offers:**

**Comprehensive Online Product Specs on Littelfuse.com**—Featuring easy-to-use navigation, search and selection tools, as well as additional product details. You can rely on **Littelfuse.com** for instant answers and continuously up-to-date information.

**Printed Product Catalogs**—For offline and off-the-shelf convenience, our printed product catalogs include data sheets, selection tables and tutorials covering all of our core technologies. Contact your Littelfuse product representative or visit [www.littelfuse.com/about-us/product-catalogs](http://www.littelfuse.com/about-us/product-catalogs) to check availability.

**Circuit Protection Design Guides**—Our application-design center website, [www.littelfuse.com/technical-resources/application-designs](http://www.littelfuse.com/technical-resources/application-designs) offers a wealth of circuit protection guidance to help you select and apply the best circuit protection solution for your application.



As the world's #1 brand in circuit protection Littelfuse offers the broadest and deepest portfolio of circuit protection products and a global network of technical support, backed by more than 85 years of application design expertise. For all of your circuit protection needs visit our Technical Resources center at [www.littelfuse.com/technical-resources](http://www.littelfuse.com/technical-resources)

- **Application Notes**
- **Application Testing**
- **SPICE Models**
- **Local Technical Support**
- **Reference Designs**
- **Product Samples**
- **Technical Articles**
- **Certification Documents**
- **Data Sheets**

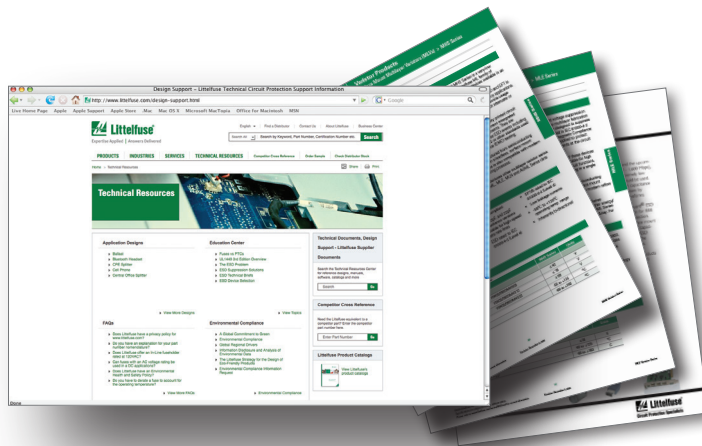

Littelfuse is the world leader in circuit protection. We offer an extensive selection of circuit protection technologies for Automotive applications. Littelfuse circuit protection expert staff can assist you in designing circuit protection for your most demanding applications. Solutions for over-current applications as well as over-voltage applications are available from Littelfuse.

**Low Current Distribution (LCD)** MICRO2, MICRO3, LP MINI, MINI, ATOF, MAXI, MCASE, LP JCASE, JCASE

**High Current Distribution (HCD)** ZCASE MASTERFUSE, MASTERFUSE, ZCASE MEGA, MIDI, BF1, MEGA, CF

**High Voltage Fuses (HEV)** OHEV

**Battery Cable Protection (BCP)** CABLE PRO and BF-Inline products for mounting directly inline as part of a high-power cable assembly

For more information, please contact your authorized Littelfuse product representative or visit our website at [www.littelfuse.com](http://www.littelfuse.com)