

DST2080S

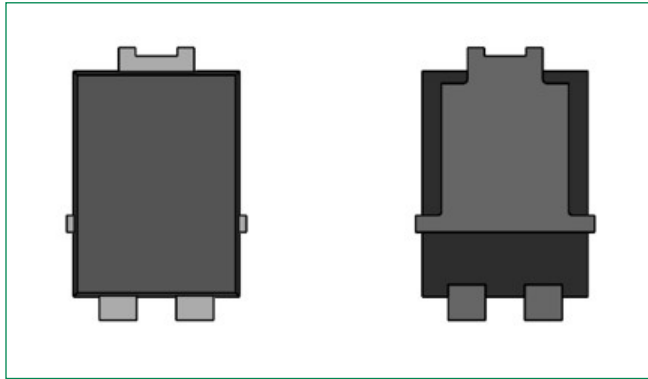

Pin out

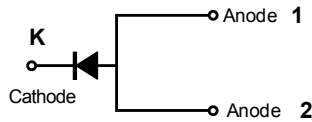

Description

Littelfuse DST series Ultra Low V_F Schottky Barrier Rectifier is designed to meet the general requirements of commercial and industry applications by providing high temperature, low leakage, and lower V_F products.

It is suitable for high-frequency switching mode power supply, free-wheeling diodes and polarity protection diodes.

Features

- Ultra low forward voltage drop
- High frequency operation
- MSL: Level 1 - unlimited
- High junction temperature capability
- Trench MOS Schottky technology
- Single die in TO-277B Package
- Pb-free E3 means 2nd level interconnect is Pb-free and the terminal finish material is tin(Sn) (IPC/ JEDEC J-STD-609A.01)

Applications

- Switching mode power supply
- DC/DC converters
- Free-Wheeling diodes
- Polarity Protection Diodes

Maximum Ratings

Parameters	Symbol	Test Conditions	Max	Unit
Peak Inverse Voltage	V_{RWM}	-	80	V
Average Forward Current (per device) *	$I_{F(AV)}$	50% duty cycle @ $T_A = 85^\circ\text{C}$ rectangular wave form	20	A
Peak One Cycle Non-Repetitive Surge Current (per leg)	I_{FSM}	8.3 ms, half Sine pulse	150	A

* Mounted on 30 mm x 30 mm pad areas aluminum PCB

Electrical Characteristics

Parameters	Symbol	Test Conditions	Typ	Max	Unit
Forward Voltage Drop (per leg) *	V_{F1}	@10A, Pulse, $T_J = 25^\circ\text{C}$	0.52	-	V
		@20A, Pulse, $T_J = 25^\circ\text{C}$	0.64	0.70	
	V_{F2}	@10A, Pulse, $T_J = 125^\circ\text{C}$	0.46	-	
		@20A, Pulse, $T_J = 125^\circ\text{C}$	0.60	0.65	
Reverse Current (per leg) *	I_{R1}	@ $V_R = \text{rated } V_R, T_J = 25^\circ\text{C}$	22	300	μA
	I_{R2}	@ $V_R = \text{rated } V_R, T_J = 125^\circ\text{C}$	11	75	mA

* Pulse Width < 300 μs , Duty Cycle < 2%

Thermal-Mechanical Specifications

Parameters	Symbol	Test Conditions	Max	Unit
Junction Temperature	T_J		-55 to +150	°C
Storage Temperature	T_{stg}		-55 to +150	°C
Typical Thermal Resistance Junction to Ambient	$R_{th,JA}$	DC operation	70	°C/W
Approximate Weight	wt		0.08	g
Case Style		TO-277B		

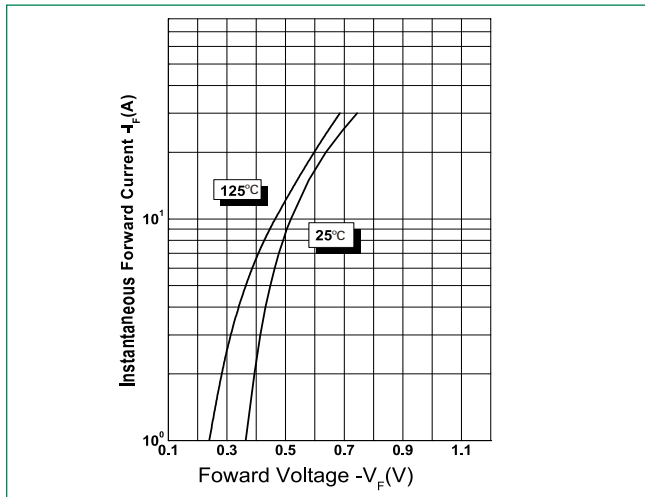
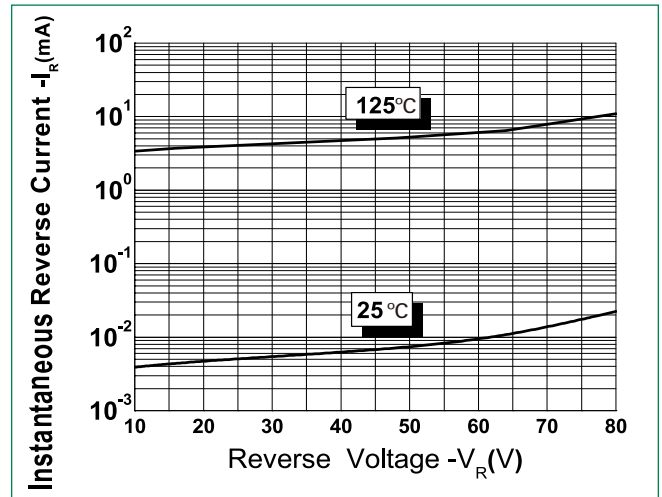
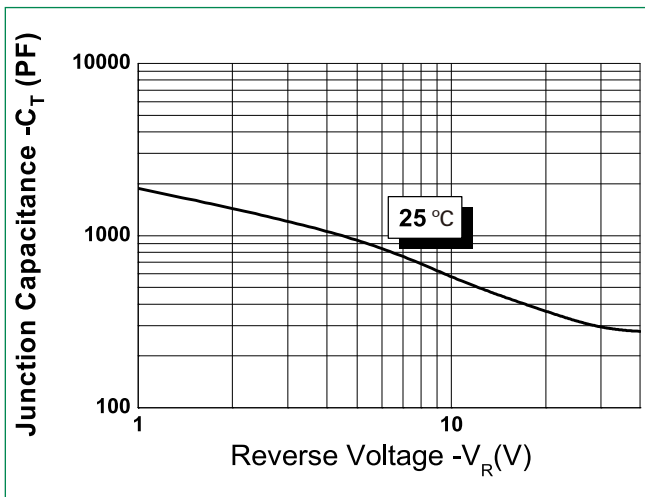
Figure 1: Typical Forward Characteristics

Figure 2: Typical Reverse Characteristics

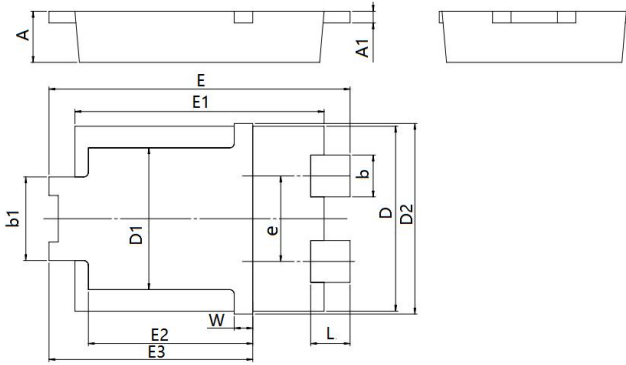
Figure 3: Typical Junction Capacitance

Dimensions-TO-277B

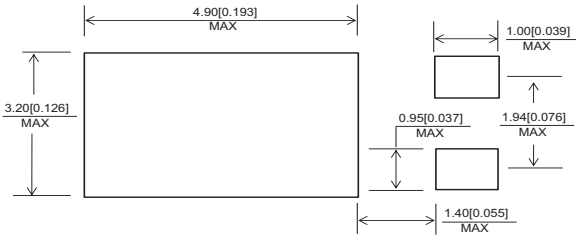

Symbol	Millimeters		Inches	
	Min	Max	Min.	Max.
A	0.95	1.25	0.037	0.049
A1	0.20	0.30	0.008	0.012
b	0.85	0.95	0.033	0.037
b1	1.70	1.90	0.067	0.075
D	3.88	4.08	0.153	0.161
D1	2.90	3.20	0.114	0.126
D2	4.25	–	0.167	–
e	1.74	1.94	0.069	0.076
E	6.30	6.70	0.248	0.264
E1	5.28	5.48	0.208	0.216
E2	3.40	3.70	0.134	0.146
E3	4.20	4.60	0.165	0.181
L	0.65	1.05	0.025	0.041
W	0.25	0.55	0.010	0.022

Mounting Pad Layout



Part Numbering and Marking System



- DST = Device Type
- 20 = Forward Current (20A)
- 80 = Reverse Voltage (80V)
- S = Package Type
- LF = Littelfuse
- YY = Year
- WW = Week
- L = Lot Number

Packing Options

Part Number	Marking	Packing Mode	M.O.Q
DST2080S	DST2080S	5000pcs / Reel	20000

Carrier Tape & Reel Specification

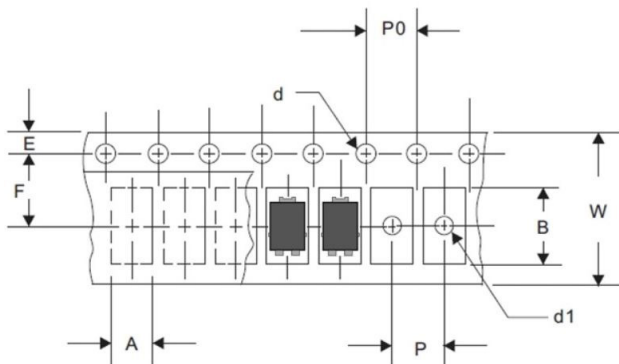

Symbol	Millimeters		Inches	
	Min	Max	Min.	Max.
A	4.28	4.48	0.168	0.176
B	6.80	7.00	0.268	0.275
d	1.40	1.60	0.055	0.063
d1	–	1.50	–	0.059
E	1.65	1.85	0.065	0.073
F	5.40	5.60	0.212	0.220
P	7.90	8.10	0.311	0.319
P0	3.90	4.10	0.153	0.161
W	11.70	12.30	0.461	0.484