

DURD560A



Description

Littelfuse DUR series Ultrafast Recovery Rectifier is designed to meet the general requirements of commercial applications by providing low T_{rr} , high-temperature, low-leakage and low forward voltage drop products. It is suitable for output rectifier, free-wheeling or boost diode in high-frequency power switching application such as switch mode power supply and DC-DC converters.

Features

- Ultra-fast switching
- Low reverse leakage current
- High surge current capability
- Low forward voltage drop
- Single die in surface
- mount TO-252 (DPAK) package
- Pb-free E3 means 2nd level interconnect is Pb-free and the terminal finish material is tin(Sn) (IPC/JEDEC J-STD-609A.01)

Circuit Diagram

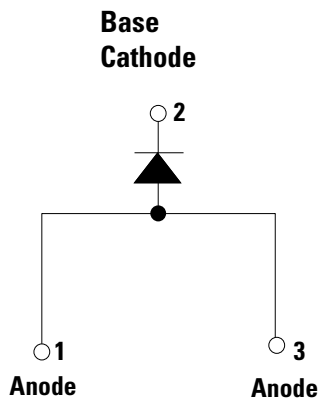

Applications

- Output rectifiers in switch mode power supplies (SMPS) and DC to DC converters
- Free-wheeling diode or boost diode in converters and motor control circuits
- Anti-parallel diode for high frequency switching devices such as IGBT
- Uninterruptible Power Supplies (UPS)
- Inductive heating and melting
- Ultrasonic cleaners and welders

Maximum Ratings

Characteristics	Symbol	Conditions	Max.	Unit
Peak Inverse Voltage	V_{RWM}	-	600	V
Average Forward Current (per device)	$I_{O(AV)}$	50% duty cycle @ $T_c=100^\circ\text{C}$, rectangular wave form	5	A
Peak One Cycle Non-Repetitive Surge Current (per leg)	I_{FSM}	8.3 ms, half sine pulse	60	A

Electrical Characteristics

Characteristics	Symbol	Conditions	Typ.	Max.	Unit
Forward Voltage Drop (Per Leg) ¹	V_{F1}	@5A, Pulse, $T_j = 25^\circ\text{C}$	1.50	1.70	V
	V_{F2}	@5A, Pulse, $T_j = 125^\circ\text{C}$	1.41	1.50	V
Reverse Current (Per Leg) ¹	I_{R1}	@ $V_R = \text{Rated } V_R, T_j = 25^\circ\text{C}$	0.10	5	μA
	I_{R2}	@ $V_R = \text{Rated } V_R, T_j = 125^\circ\text{C}$	52	500	μA
Reverse Recovery Time (Per Leg)	t_{rr1}	$I_F=500\text{mA}, I_R=1\text{A}, \text{and } I_{rm}=250\text{mA}$	-	35	ns

Footnote 1: Pulse Width < 300 μs , Duty Cycle < 2%

Thermal-Mechanical Specifications

Characteristics	Symbol	Conditions	Specification	Unit
Junction Temperature	T_J	-	-55 to +150	°C
Storage Temperature	T_{stg}	-	-55 to +150	°C
Typical Thermal Resistance Junction to Case	$R_{\theta JC}$	-	4.5	°C/W
Approximate Weight	wt	-	0.39	g
Case Style	-	DPAK (TO-252)	-	-

Figure 1: Typical Forward Characteristics

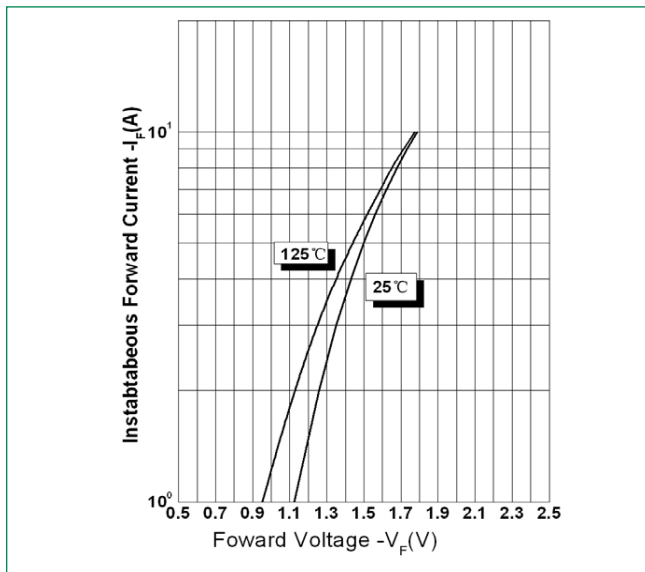

Figure 2: Typical Reverse Characteristics

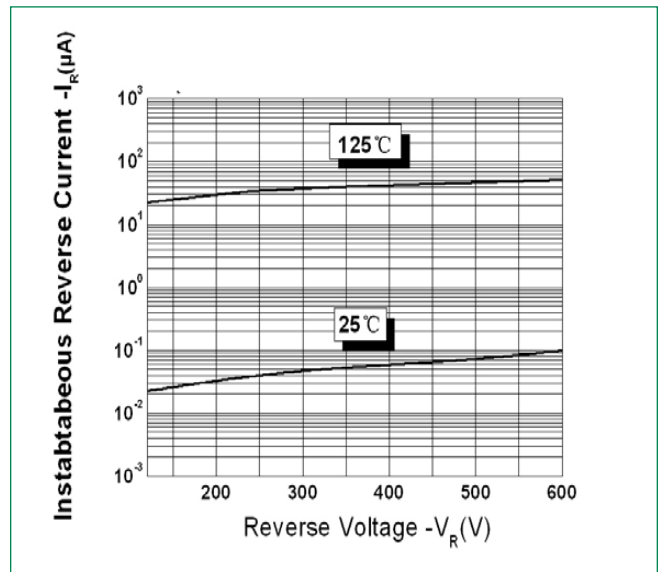
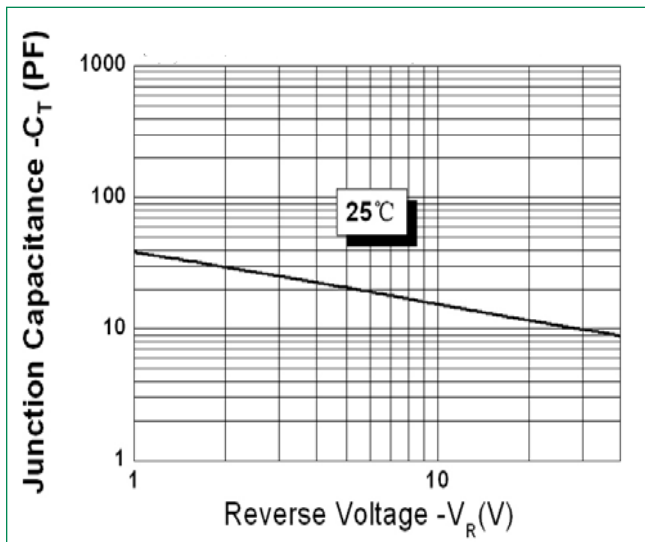
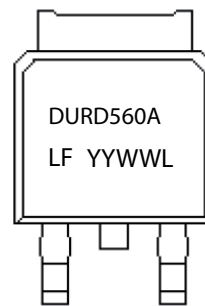

Figure 3: Typical Junction Capacitance



Part Numbering and Marking System



- DUR = Device Type
- D = Package type
- 5 = Forward Current (5A)
- 60 = Reverse Voltage (600V)
- A = A
- LF = Littelfuse
- YY = Year
- WW = Week
- L = Lot Number

Packing Options

Part Number	Marking	Packing Mode	M.O.Q
DURD560A	DURD560A	2500pcs / reel	2500

Dimensions-DPAK(TO-252)

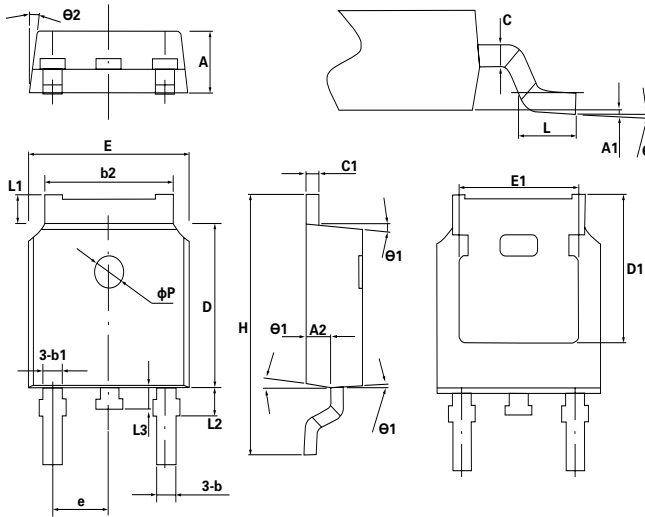

Symbol	Min.	Typ.	Max..
A	2.2	2.3	2.38
A1	0	-	0.1
A2	0.9	1.01	1.1
b	0.71	0.76	0.86
b1		0.76	
b2	5.13	5.33	5.46
c	0.47	0.5	0.6
c1	0.47	0.5	0.6
D	6	6.1	6.2
D1	-	5.3	-
E	6.5	6.6	6.7
E1	-	4.8	-
e	2.286BSC		
H	9.7	10.1	10.4
L	1.4	1.5	1.7
L1	0.9	-	1.25
L2		1.05	
L3		0.8	
øP		1.2	
θ	0°	-	8°
θ1	5°	7°	9°
θ2	5°	7°	9°

Carrier Tape & Reel Specification

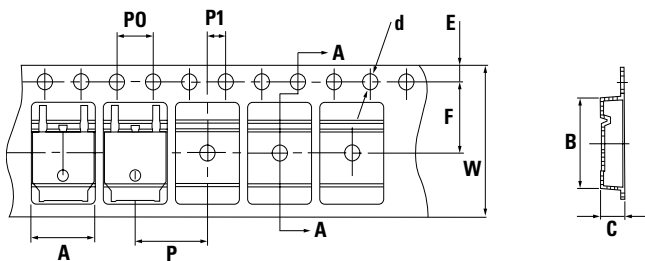

Symbol	Millimeters	
	Min	Max
A	6.80	7.00
B	10.40	10.60
C	2.60	2.80
d	ø1.45	ø1.65
E	1.65	1.85
F	7.40	7.60
P0	3.90	4.10
P	7.90	8.10
P1	1.90	2.10
W	15.50	16.50