

Ultrafast Recovery Rectifier

DURF1030CTR, 2x 5A, 300V, ITO-220AB, Common Anode

DURF1030CTR

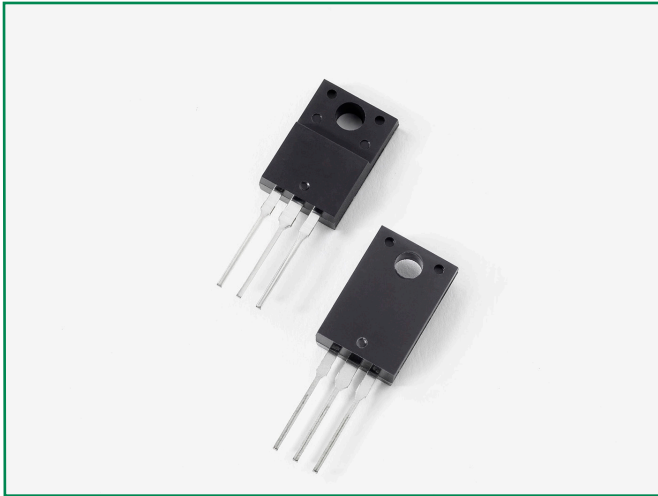

Description

Littelfuse DUR series Ultrafast Recovery Rectifier is designed to meet the general requirements of commercial applications by providing low T_{rr} , high-temperature, low-leakage and low forward voltage drop products. It is suitable for output rectifier, free-wheeling or boost diode in high-frequency power switching application such as switch mode power supply and DC-DC converters.

Features

- Ultra-fast switching
 - Low reverse leakage current
 - High surge current capability
 - Low forward voltage drop
 - Common Anode
- configuration in electrically isolated ITO-220AB package
- Pb-free E3 means 2nd level interconnect is Pb-free and the terminal finish material is tin(Sn) (IPC/ JEDEC J-STD-609A.01)

Circuit Diagram

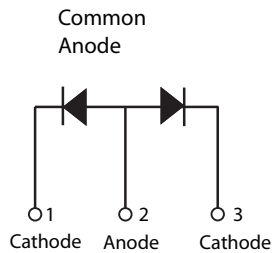

Applications

- Output rectifiers in switch mode power supplies (SMPS) and DC to DC converters
- Free-wheeling diode or boost diode in converters and motor control circuits
- Anti-parallel diode for high frequency switching devices such as IGBT
- Uninterruptible Power Supplies (UPS)
- Inductive heating and melting
- Ultrasonic cleaners and welders

Maximum Ratings

| Characteristics | Symbol | Conditions | Max. | Unit |
|---|-------------|--|--------------------|------|
| Peak Inverse Voltage | V_{RWM} | - | 300 | V |
| Average Forward Current | $I_{F(AV)}$ | 50% duty cycle @ $T_c = 112^\circ\text{C}$, rectangular wave form | 5 (Per Leg) | A |
| | | | 10 (Total Device) | |
| Peak One Cycle Non-Repetitive Surge Current | I_{FSM} | 8.3 ms, half sine pulse | 80 | A |

Electrical Characteristics

| Characteristics | Symbol | Conditions | Max. | Unit |
|---------------------------------|-----------|--|------|---------------|
| Forward Voltage Drop (Per Leg) | V_F | @ $I_F = 5\text{A}$, Pulse, $T_j = 25^\circ\text{C}$ | 1.3 | V |
| Reverse Current | I_{R1} | @ $V_R = \text{Rated } V_R$, $T_j = 25^\circ\text{C}$ | 30 | μA |
| | I_{R2} | @ $V_R = \text{Rated } V_R$, $T_j = 125^\circ\text{C}$ | 250 | |
| Max. Reverse Recovery Time | t_{rr1} | $I_F = 500\text{mA}$, $I_R = 1\text{A}$, and $I_{rm} = 250\text{mA}$ | 45 | ns |

Footnote 1: Pulse Width < 300 μs , Duty Cycle < 2%

Thermal-Mechanical Specifications

| Characteristics | Symbol | Conditions | Specification | Unit |
|---|-----------------|--------------|---------------|------|
| Junction Temperature | T_J | - | -55 to +150 | °C |
| Storage Temperature | T_{stg} | - | -55 to +150 | °C |
| Typical Thermal Resistance Junction to Case | $R_{\theta JC}$ | DC operation | 3.5 | °C/W |
| Approximate Weight | wt | - | 2.0 | g |
| Case Style | - | ITO-220AB | - | - |

Figure 1: Typical Forward Characteristics

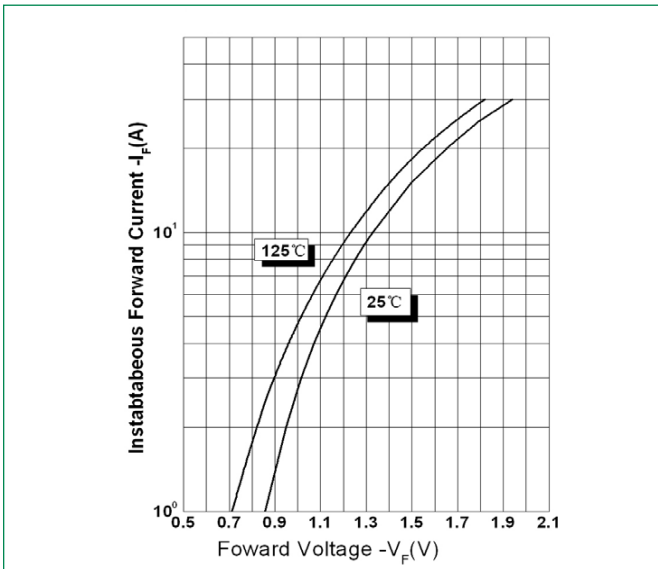

Figure 2: Typical Reverse Characteristics

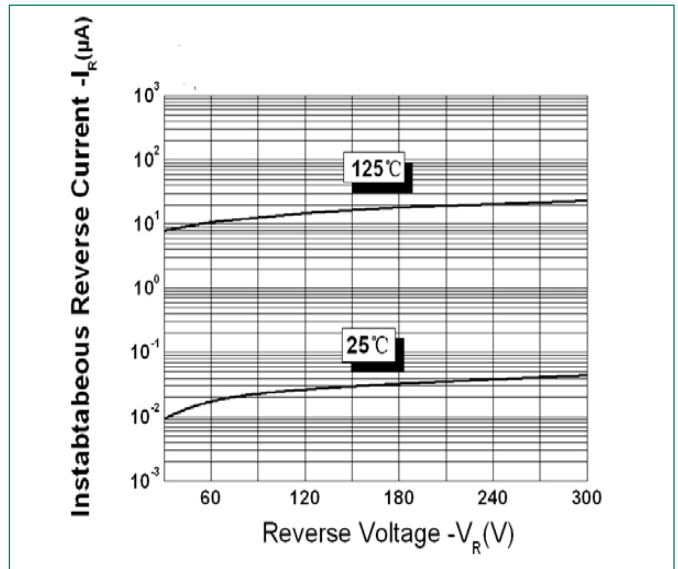
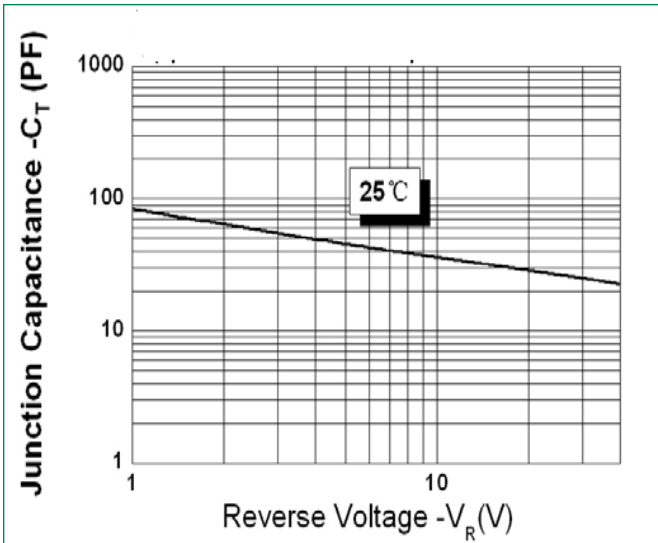
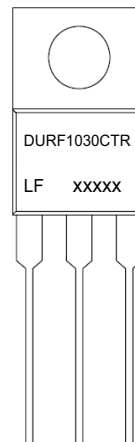

Figure 3: Typical Junction Capacitance



Part Numbering and Marking System



- *xxxxx is YYWWL
- DUR = Device Type
 - F = Package type
 - 10 = Forward Current (10A)
 - 30 = Reverse Voltage (300V)
 - CTR = Configuration
 - LF = Littelfuse
 - YY = Year
 - WW = Week
 - L = Lot Number

Ultrafast Recovery Rectifier

DURF1030CTR, 2x 5A, 300V, ITO-220AB, Common Anode

Packing Options

| Part Number | Marking | Packing Mode | M.O.Q |
|-------------|-------------|--------------|-------|
| DURF1030CTR | DURF1030CTR | 50pcs /Tube | 1000 |

Dimensions-Package ITO-220AB

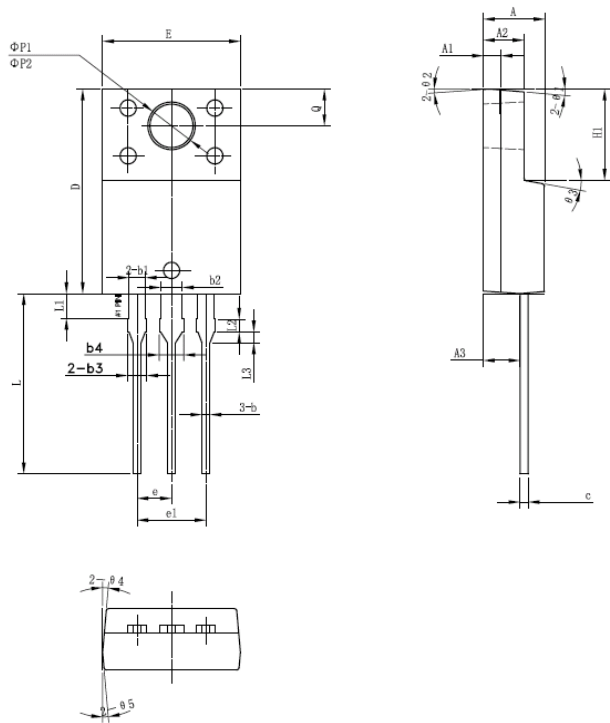

| Symbol | Millimeters | | |
|------------|-------------|-------|-------|
| | Min | Typ | Max |
| A | 4.30 | 4.50 | 4.70 |
| A1 | 1.10 | 1.30 | 1.50 |
| A2 | 2.80 | 3.00 | 3.20 |
| A3 | 2.50 | 2.70 | 2.90 |
| b | 0.50 | 0.60 | 0.75 |
| b1 | 1.10 | 1.20 | 1.35 |
| b2 | 1.50 | 1.60 | 1.75 |
| b3 | 1.20 | 1.30 | 1.45 |
| b4 | 1.60 | 1.70 | 1.85 |
| c | 0.55 | 0.60 | 0.75 |
| D | 14.80 | 15.00 | 15.20 |
| E | 9.96 | 10.16 | 10.36 |
| e | | 2.55 | |
| e1 | | 5.10 | |
| H1 | 6.50 | 6.70 | 6.90 |
| L | 12.70 | 13.20 | 13.70 |
| L1 | 1.60 | 1.80 | 2.00 |
| L2 | 0.80 | 1.00 | 1.20 |
| L3 | 0.60 | 0.80 | 1.00 |
| $\phi P1$ | 3.30 | 3.50 | 3.70 |
| $\phi P2$ | 2.99 | 3.19 | 3.39 |
| Q | 2.50 | 2.70 | 2.90 |
| $\theta 1$ | | 5° | |
| $\theta 2$ | | 4° | |
| $\theta 3$ | | 10° | |
| $\theta 4$ | | 5° | |
| $\theta 5$ | | 5° | |

Tube Specification ITO-220AB

