

SP1003 Series - 30pF 30kV Unidirectional Discrete TVS

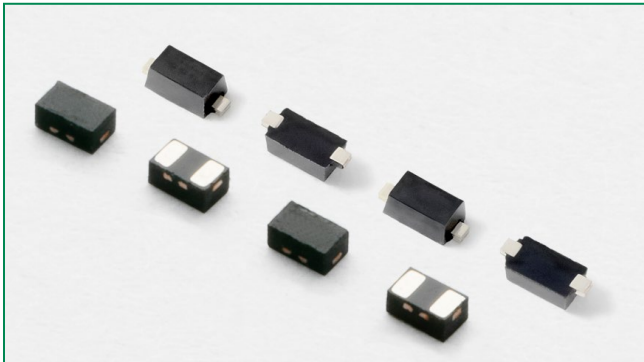

Pinout

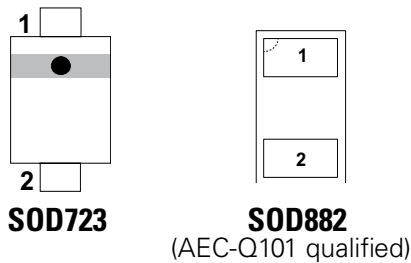

Functional Block Diagram



Description

The SP1003 diodes are fabricated in a proprietary silicon avalanche technology. These diodes provide a high ESD (electrostatic discharge) protection level for electronic equipment. The SP1003 TVS can safely absorb repetitive ESD strikes at $\pm 30\text{kV}$ (contact discharge, IEC 61000-4-2) without performance degradation. Additionally, each diode can safely dissipate 7A of 8/20 μs surge current (IEC 61000-4-5) with very low clamping voltages.

Features

- ESD, IEC 61000-4-2, $\pm 30\text{kV}$ contact, $\pm 30\text{kV}$ air
- EFT, IEC 61000-4-4, 40A (5/50ns)
- Lightning, 7A (8/20 μs as defined in IEC 61000-4-5 2nd edition)
- Low leakage current of 100nA (MAX) at 5V
- Tiny SOD723/ SOD882 (JEDEC MO-236) package saves board space
- Fits solder footprint of industry standard 0402 (1005) components
- AEC-Q101 qualified (SOD882 package)

Applications

- Mobile phones components
- Smart phones • Digital cameras
- PDAs • Portable medical components
- Portable navigation

Application Example

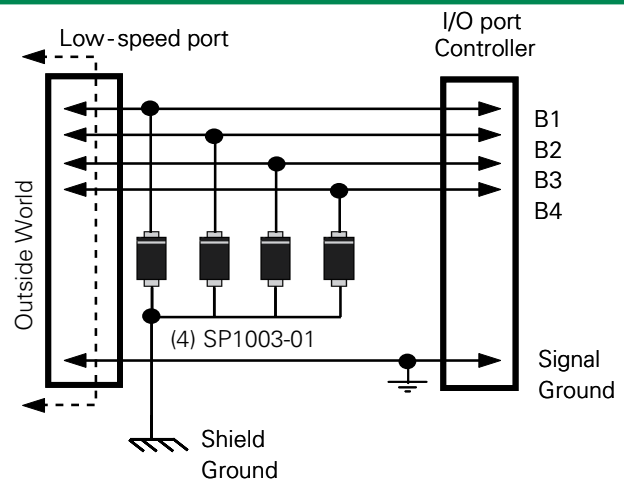

Life Support Note:
Not Intended for Use in Life Support or Life Saving Applications
The products shown herein are not designed for use in life sustaining or life saving applications unless otherwise expressly indicated.

Absolute Maximum Ratings

Symbol	Parameter	Value	Units
I_{PP}	Peak Pulse Current ($t_p=8/20\mu s$)	7.0	A
T_{OP}	Operating Temperature	-40 to 125	°C
T_{STOR}	Storage Temperature	-55 to 150	°C

CAUTION: Stresses above those listed in "Absolute Maximum Ratings" may cause permanent damage to the component. This is a stress only rating and operation of the component at these or any other conditions above those indicated in the operational sections of this specification is not implied.

Electrical Characteristics ($T_{OP}=25^\circ C$)

Parameter	Symbol	Test Conditions	Min	Typ	Max	Units
Forward Voltage Drop	V_F	$I_F = 10mA$		0.8	1.2	V
Breakdown Voltage	V_{BR}	$I_R = 1mA$	6.0	7.8	8.5	V
Reverse Standoff Voltage	V_{RWM}	$I_R = 1\mu A$			5.0	V
Reverse Leakage Current	I_{LEAK}	$V_R=5V$, I/O to GND			100	nA
Clamp Voltage ¹	V_C	$I_{pp}=6A$ $t_p=8/20\mu s$		11.4		V
		$I_{pp}=7A$ $t_p=8/20\mu s$		12.0		V
Dynamic Resistance ²	R_{DYN}	TLP, $t_p=100ns$, I/O to GND		0.25		Ω
ESD Withstand Voltage ¹	V_{ESD}	IEC 61000-4-2 (Contact Discharge)		± 30		kV
		IEC 61000-4-2 (Air Discharge)		± 30		kV
Diode Capacitance ¹	$C_{I/O-GND}$	Reverse Bias=0V, $f=1$ MHz		30		pF

Note: 1 - Parameter is guaranteed by design and/or component characterization.

2 - Transmission Line Pulse (TLP) with 100ns width, 2ns rise time, and average window $t_1=70ns$ to $t_2=90ns$

Capacitance vs. Reverse Bias

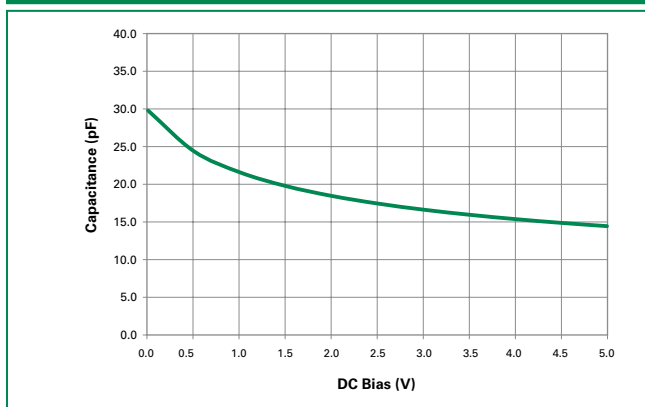

Clamping Voltage vs. I_{pp}

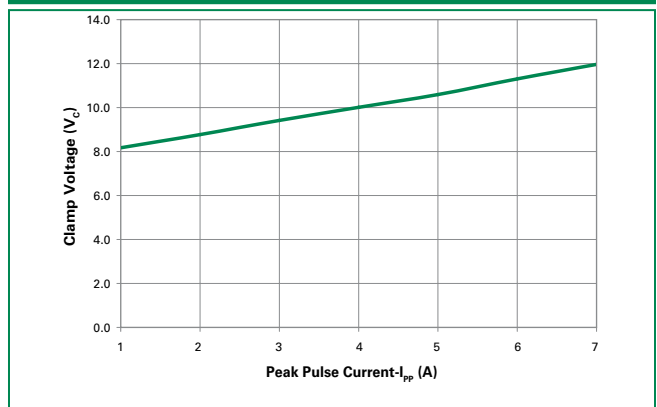

Transmission Line Pulsing(TLP) Plot

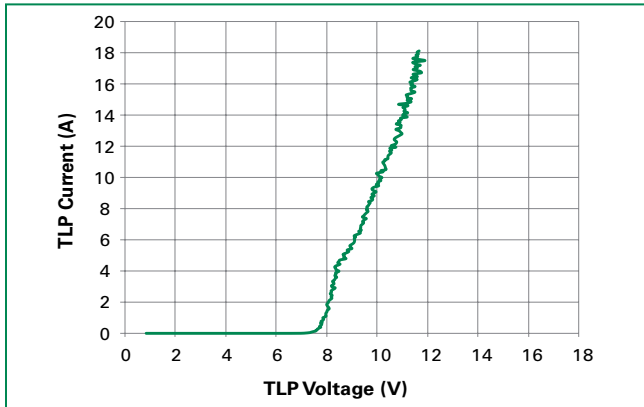

Leakage vs. Temperature

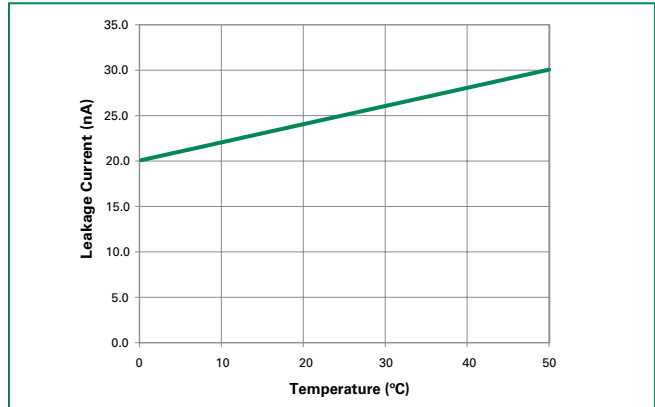

8/20µs Pulse Waveform

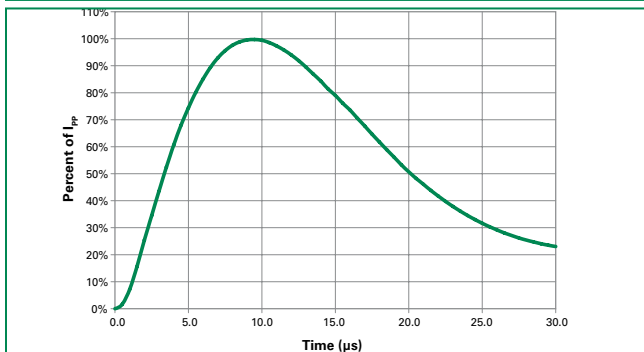

Soldering Parameters

Reflow Condition		Pb – Free assembly
Pre Heat	- Temperature Min ($T_{s(min)}$)	150°C
	- Temperature Max ($T_{s(max)}$)	200°C
	- Time (min to max) (t_s)	60 – 180 secs
Average ramp up rate (Liquidus) Temp (T_L) to peak		3°C/second max
$T_{s(max)}$ to T_L - Ramp-up Rate		3°C/second max
Reflow	- Temperature (T_L) (Liquidus)	217°C
	- Temperature (t_L)	60 – 150 seconds
Peak Temperature (T_p)		260 ^{+0/-5} °C
Time within 5°C of actual peak Temperature (t_p)		20 – 40 seconds
Ramp-down Rate		6°C/second max
Time 25°C to peak Temperature (T_p)		8 minutes Max.
Do not exceed		260°C

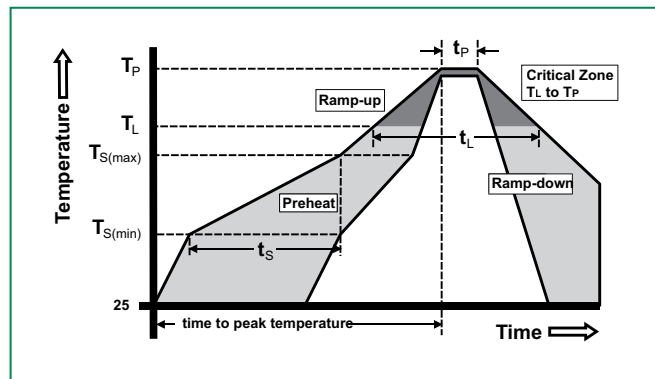

Part Numbering System

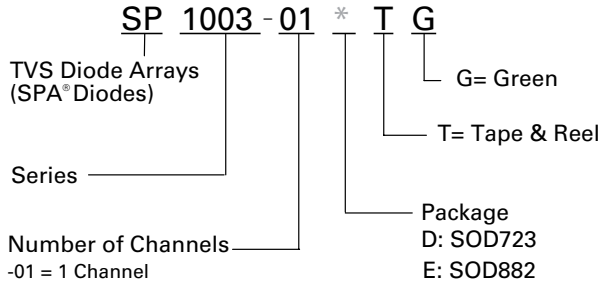

Part Marking System

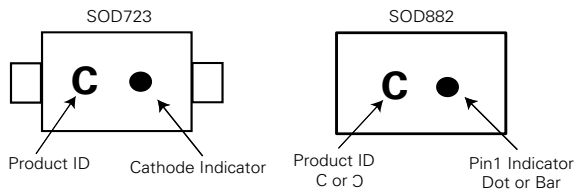

Product Characteristics

Lead Plating	Pre-Plated Frame or Matte Tin
Lead Material	Copper Alloy
Lead Coplanarity	0.004 inches(0.102mm)
Substrate material	Silicon
Body Material	Molded Compound
Flammability	UL Recognized compound meeting flammability rating V-0

Ordering Information

Part Number	Package	Min. Order Qty.
SP1003-01DTG	SOD723	8000
SP1003-01ETG	SOD882	10000

Package Dimensions — SOD723

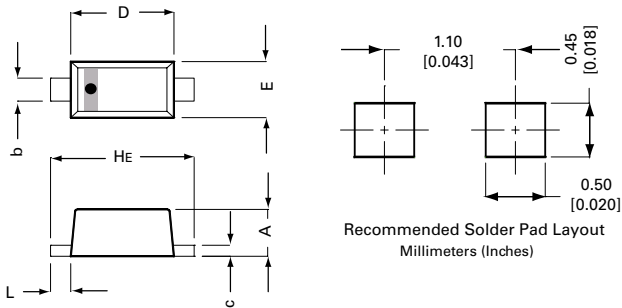

Symbol	SOD723			
	Millimeters		Inches	
	Min	Max	Min	Max
A	0.46	0.65	0.018	0.026
b	0.23	0.35	0.009	0.014
c	0.08	0.15	0.003	0.006
D	0.90	1.10	0.035	0.043
E	0.55	0.65	0.022	0.026
HE	1.30	1.50	0.051	0.059
L	0.15	0.25	0.006	0.010

Package Dimensions — SOD882

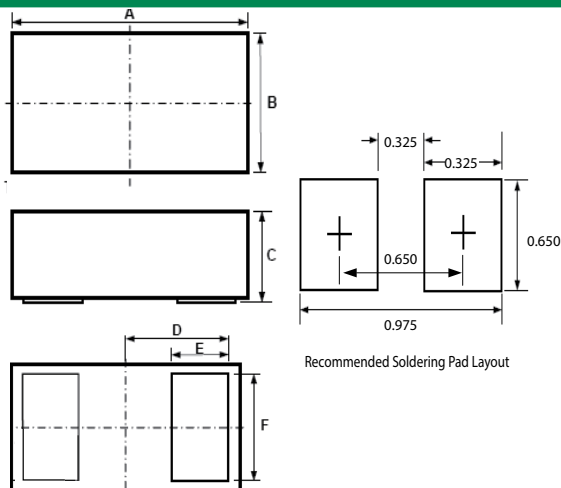

Symbol	Package	SOD882				
	JEDEC	MO-236				
	Millimeters			Inches		
	Min	Typ	Max	Min	Typ	Max
A	0.90	1.00	1.10	0.035	0.039	0.043
B	0.50	0.60	0.70	0.020	0.024	0.028
C	0.40	0.50	0.60	0.016	0.020	0.024
D	0.45			0.018		
E	0.20	0.25	0.35	0.008	0.010	0.014
F	0.45	0.50	0.55	0.018	0.020	0.022

Embossed Carrier Tape & Reel Specification – SOD723

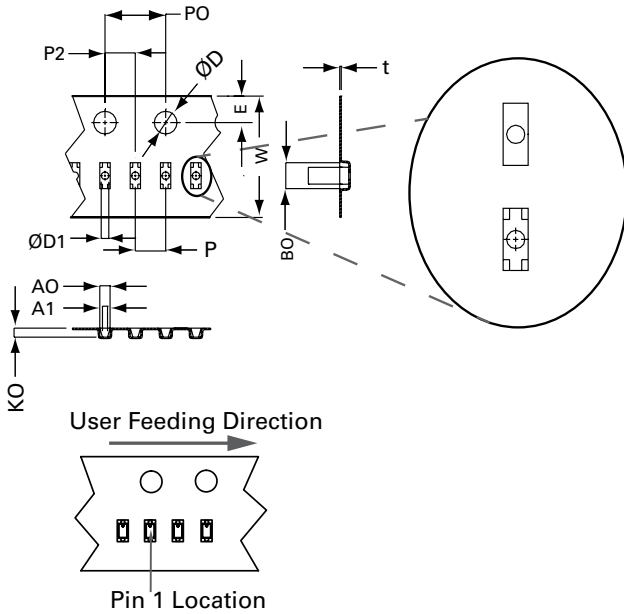

Symbol	Millimetres		Inches	
	Min	Max	Min	Max
E	1.65	1.85	0.064	0.072
F	3.40	3.60	0.134	0.142
D1	0.45	0.55	0.017	0.021
D	1.50	-	0.060	-
PO	3.90	4.10	0.153	0.161
10PO	40.0 ± 0.20		1.570 ± 0.010	
W	7.90	8.20	0.311	0.322
P2/P	1.90	2.10	0.074	0.082
AO	0.65	0.81	0.026	0.032
A1	0.33 REF		0.010 REF	
BO	1.51	1.76	0.059	0.069
B1	1.10 REF		0.040 REF	
KO	0.54	0.78	0.021	0.031
t	-	0.21	-	0.008

Embossed Carrier Tape & Reel Specification – SOD882

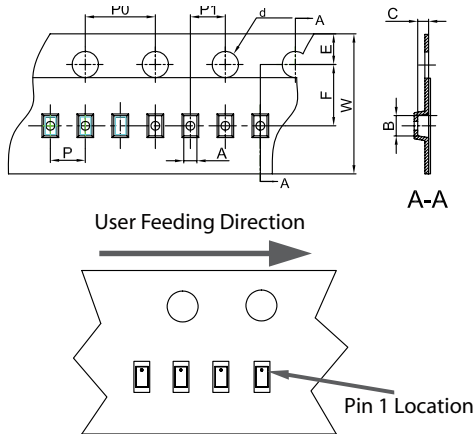

Symbol	Millimetres		Inches	
	Min	Max	Min	Max
A	0.65	0.70	0.026	0.028
B	1.10	1.20	0.043	0.047
C	0.50	0.60	0.020	0.024
dØ	1.40	1.60	0.055	0.063
E	1.65	1.85	0.065	0.073
F	3.40	3.60	0.134	0.142
P0	3.90	4.10	0.154	0.161
P	1.90	2.10	0.075	0.083
P1	1.90	2.10	0.075	0.083
W	7.90	8.10	0.311	0.319

