

SP1011 Series 7pF 15kV Unidirectional TVS Array

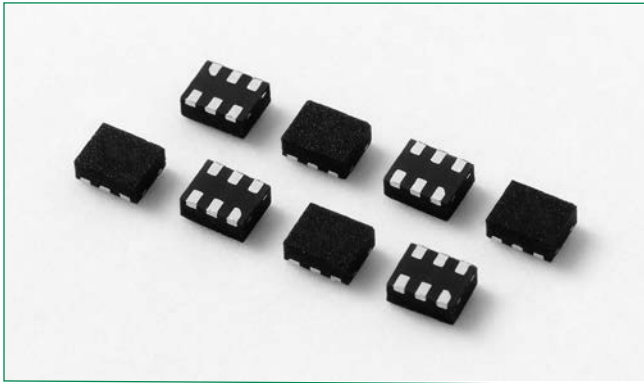

Pinout

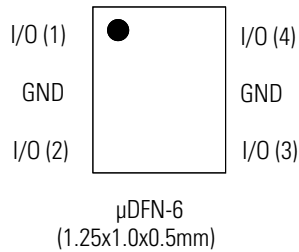

Functional Block Diagram

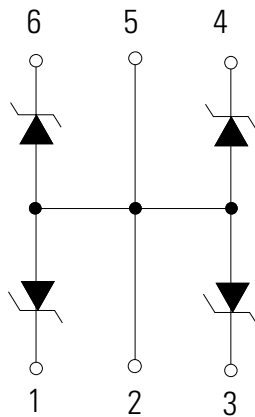

Description

Avalanche breakdown diodes fabricated in a proprietary silicon avalanche technology protect each I/O pin to provide a high level of protection for electronic equipment that may experience destructive electrostatic discharges (ESD). These robust diodes can safely absorb repetitive ESD strikes above the maximum level specified in IEC 61000-4-2 international standard (Level 4, ±8kV contact discharge) without performance degradation. Their very low loading capacitance also makes them ideal for protection high-speed signal pins.

Features

- RoHS compliant and lead-free
- ESD, IEC 61000-4-2, ±15kV contact, ±30kV air
- Lightning, 2A (8/20μs as defined in IEC 61000-4-5 2nd Edition)
- Low capacitance of 7 pF (TYP) per I/O @ 2.5V
- Low leakage current of 1μA (MAX) at 5V
- Tiny μDFN(JEDEC MO-229) package (1.25mm x 1.0mm x 0.5mm)
- EFT protection IEC 61000-4-4, 40A (5/50ns)

Applications

- LCD/PDP TV
- DVD Player
- Desktop
- Set Top Box
- Mobile Phone
- Notebook
- MP3/PMP
- Digital camera

Application Example

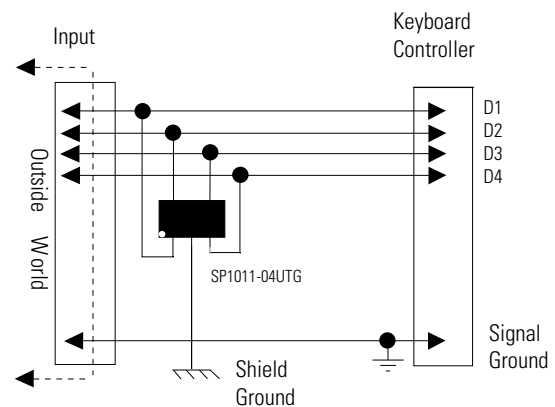

Life Support Note:

Not Intended for Use in Life Support or Life Saving Applications

The products shown herein are not designed for use in life sustaining or life saving applications unless otherwise expressly indicated.

Absolute Maximum Ratings

Symbol	Parameter	Value	Units
I_{PP}	Peak Pulse Current ($t_p=8/20\mu s$)	2	A
T_{OP}	Operating Temperature	-40 to 125	°C
T_{STOR}	Storage Temperature	-55 to 150	°C

CAUTION: Stresses above those listed in "Absolute Maximum Ratings" may cause permanent damage to the component. This is a stress only rating and operation of the component at these or any other conditions above those indicated in the operational sections of this specification is not implied.

Thermal Information

Parameter	Rating	Units
Storage Temperature Range	-55 to 150	°C
Maximum Junction Temperature	150	°C
Maximum Lead Temperature (Soldering 20-40s)	260	°C

Electrical Characteristics ($T_{OP}=25^\circ C$)

Parameter	Symbol	Test Conditions	Min	Typ	Max	Units
Reverse Voltage Drop	V_R	$I_R = 1mA$	7.0	7.8	8.5	V
Reverse Standoff Voltage	V_{RWM}	$I_R \leq 1\mu A$			6	V
Reverse Leakage Current	I_{LEAK}	$V_R = 5V$		0.1	1	μA
Clamp Voltage ¹	V_C	$I_{PP}=1A, t_p=8/20\mu s, Fwd$		8.7		V
		$I_{PP}=2A, t_p=8/20\mu s, Fwd$		10.2		V
Dynamic Resistance	R_{DYN}	$(V_{C2} - V_{C1}) / (I_{PP2} - I_{PP1})$		1.5		Ω
ESD Withstand Voltage ¹	V_{ESD}	IEC 61000-4-2 (Contact Discharge)	± 15			kV
		IEC 61000-4-2 (Air Discharge)	± 30			kV
Diode Capacitance ¹	C_D	Reverse Bias = 0V		12	15	pF
		Reverse Bias = 2.5V		7		pF

Note:

1. Parameter is guaranteed by design and/or component characterization.

Capacitance vs. Reverse Bias

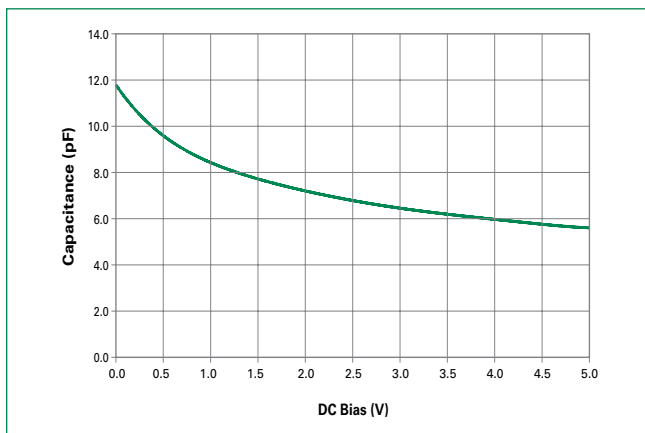

Insertion Loss (S21) I/O to GND

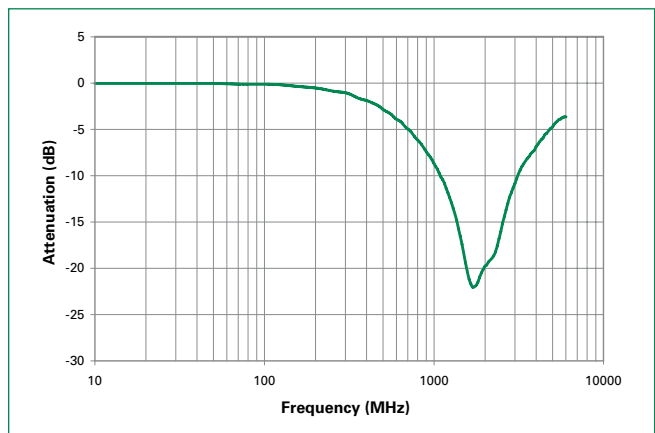

Soldering Parameters

Reflow Condition		Pb – Free assembly
Pre Heat	- Temperature Min ($T_{s(min)}$)	150°C
	- Temperature Max ($T_{s(max)}$)	200°C
	- Time (min to max) (t_s)	60 – 180 secs
Average ramp up rate (Liquidus) Temp (T_L) to peak		3°C/second max
$T_{S(max)}$ to T_L - Ramp-up Rate		3°C/second max
Reflow	- Temperature (T_L) (Liquidus)	217°C
	- Temperature (t_L)	60 – 150 seconds
Peak Temperature (T_p)		260 ^{+0.5} °C
Time within 5°C of actual peak Temperature (t_p)		20 – 40 seconds
Ramp-down Rate		6°C/second max
Time 25°C to peak Temperature (T_p)		8 minutes Max.
Do not exceed		260°C

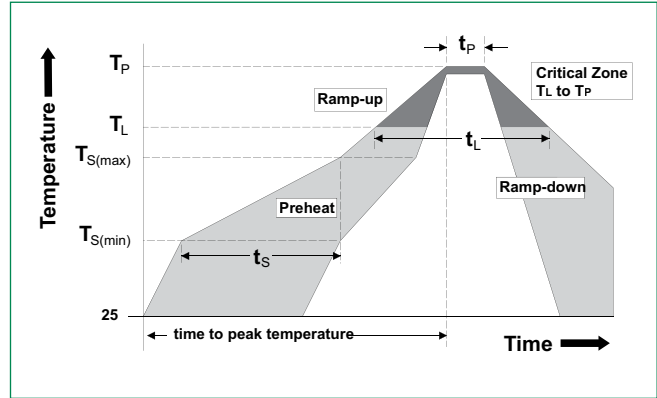

Package Dimensions – μ DFN-6 (1.25x1.0x0.5mm)

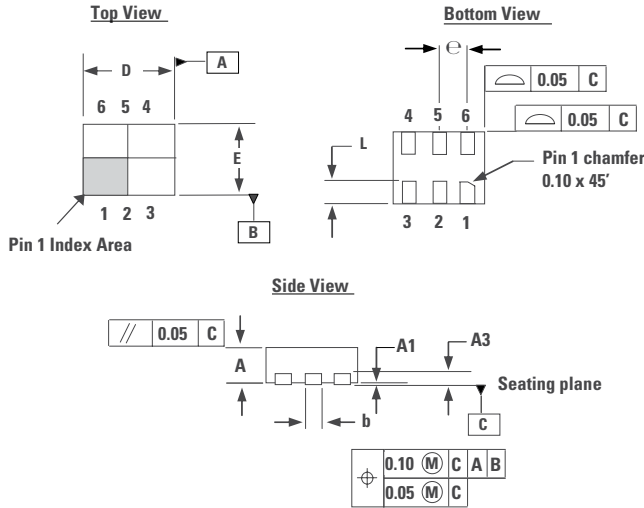

Package	μ DFN-6 (1.25x1.0x0.5mm)			
JEDEC	MO-229			
Symbol	Millimeters		Inches	
	Min	Max	Min	Max
A	0.45	0.55	0.018	0.022
A1	0.00	0.05	0.000	0.002
A3	0.127 REF		0.005 REF	
b	0.15	0.25	0.006	0.010
D	1.20	1.30	0.047	0.051
D2	-	-	-	-
E	0.95	1.05	0.037	0.041
E2	-	-	-	-
e	0.4 REF		0.016 REF	
L	0.25	0.35	0.010	0.014

Recommended Soldering Pad for μ DFN-6L 1.25 x1.0x0.5 mm

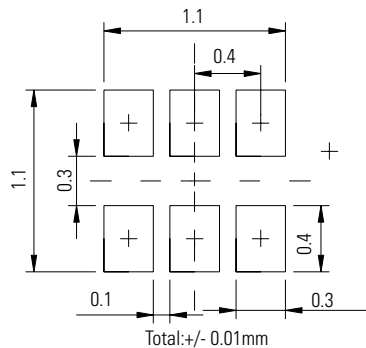

Part Numbering System

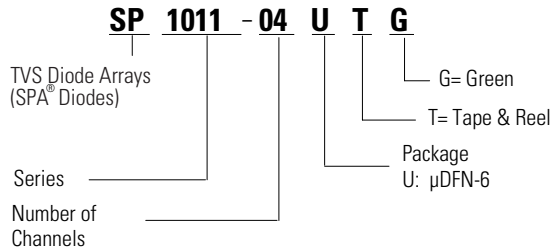

Product Characteristics

Lead Plating	Pre-Plated Frame
Lead Material	Copper Alloy
Lead Coplanarity	0.004 inches(0.102mm)
Substrate material	Silicon
Body Material	Molded Compound
Flammability	UL Recognized compound meeting flammability rating V-0

Part Marking System

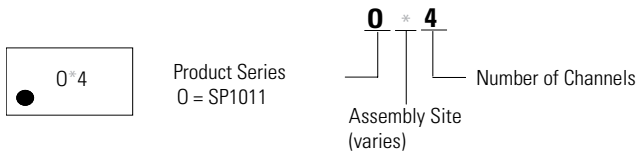

Ordering Information

Part Number	Package	Min. Order Qty.
SP1011-04UTG	μDFN-6 (1.25x1.0x0.5mm)	3000

Embossed Carrier Tape & Reel Specification —μDFN-6 (1.25x1.0x0.5mm)

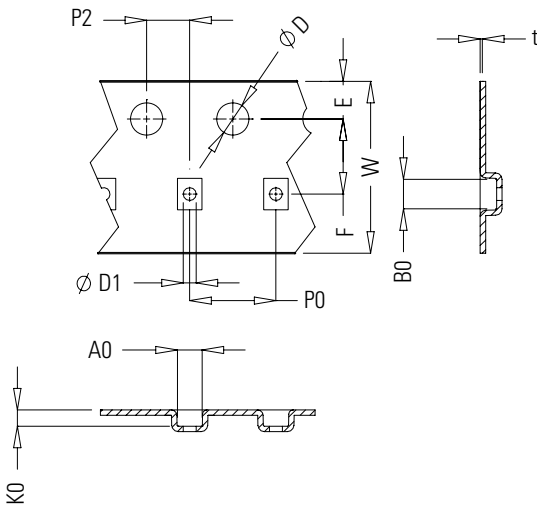

Symbol	Millimeters		Inches	
	Min	Max	Min	Max
E	1.65	1.85	0.06	0.07
F	3.45	3.55	0.14	0.14
D1	0.50	0.65	0.02	0.03
D	1.50 MIN		0.06 MIN	
P0	3.90	4.10	0.15	0.16
10P0	40.0 +/- 0.20		1.57 +/- 0.01	
W	7.90	8.30	0.31	0.33
P2	1.95	2.05	0.08	0.08
A0	1.09	1.19	0.04	0.05
B0	1.42	1.52	0.06	0.06
K0	0.71	0.81	0.03	0.03
t	0.25 TYP		0.01 TYP	