

## SP4065 Series 3.3V 20A Diode Array

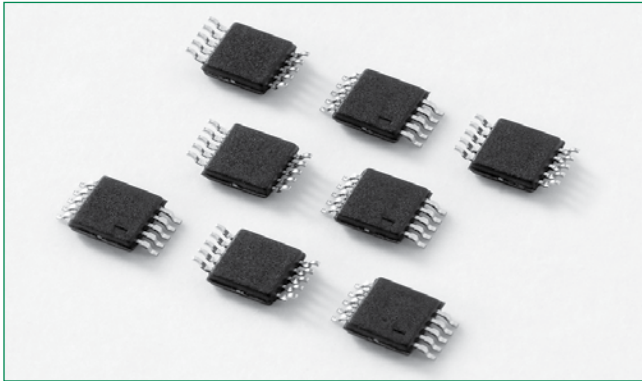

### Pinout

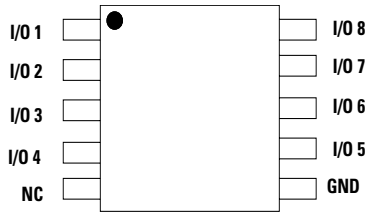

### Functional Block Diagram

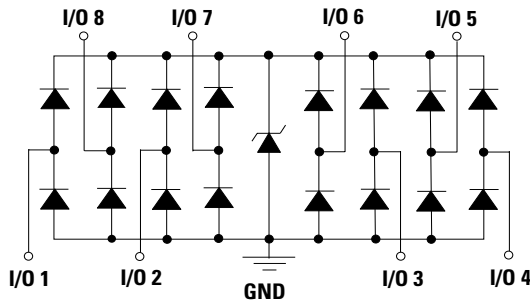

### Additional Information



Datasheet



Resources



Samples

Life Support Note:

**Not Intended for Use in Life Support or Life Saving Applications**

The products shown herein are not designed for use in life sustaining or life saving applications unless otherwise expressly indicated.

### Description

The SP4065 integrates low capacitance diodes with an additional zener diode to protect each I/O pin against ESD and high surge events. This robust device can safely absorb up to 20A per IEC 61000-4-5, 2nd Edition ( $t_p=8/20\mu s$ ) without performance degradation and a minimum  $\pm 30kV$  ESD per IEC 61000-4-2 International Standard. Their low loading capacitance also makes them ideal for protecting highspeed signal pins.

### Features

- ESD, IEC 61000-4-2,  $\pm 30kV$  contact,  $\pm 30kV$  air
- EFT, IEC 61000-4-4, 40A (5/50ns)
- Lightning, IEC 61000-4-5, 2nd Edition 20A (8/20 $\mu s$ )
- Low capacitance of 4.4pF (TYP) per I/O
- Low leakage current of  $1\mu A$  (MAX) at 3.3V
- Halogen free, Lead-free and RoHS compliant
- Moisture Sensitivity Level (MSL - Level 1)

### Applications

- LCD/LED TVs
- Desktops
- Game Consoles
- Set Top Boxes
- Notebooks
- 1Gb Ethernet
- Network Hardware
- Small Cells

### Application Example

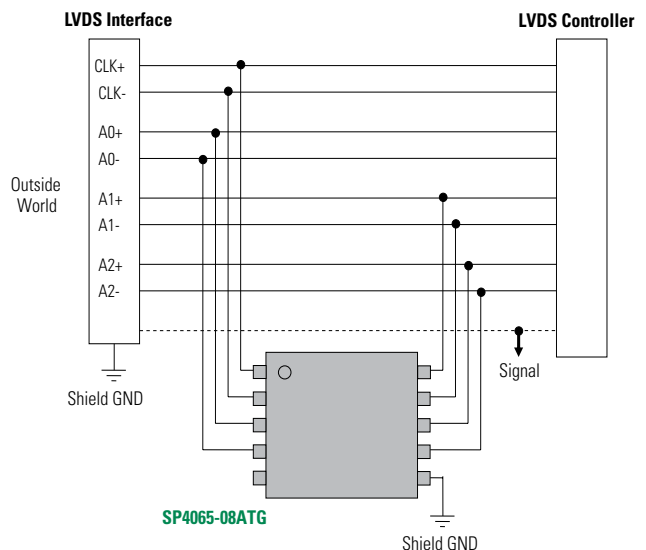

### Absolute Maximum Ratings

Symbol	Parameter	Value	Units
$I_{PP}$	Peak Current ( $t_p=8/20\mu s$ )	20.0	A
$P_{PK}$	Peak Pulse Power ( $t_p=8/20\mu s$ )	300	W
$T_{OP}$	Operating Temperature	-40 to 125	°C
$T_{STOR}$	Storage Temperature	-55 to 150	°C

**CAUTION:** Stresses above those listed in "Absolute Maximum Ratings" may cause permanent damage to the device. This is a stress only rating and operation of the device at these or any other conditions above those indicated in the operational sections of this specification is not implied.

### Thermal Information

Parameter	Rating	Units
Storage Temperature Range	-55 to 150	°C
Maximum Junction Temperature	150	°C
Maximum Lead Temperature (Soldering 20-40s)	260	°C

### Electrical Characteristics ( $T_{OP}=25^\circ C$ )

Parameter	Symbol	Test Conditions	Min	Typ	Max	Units
Reverse Standoff Voltage	$V_{RWM}$				3.3	V
Snap Back Voltage	$V_{SB}$	$I_{SB}=50mA$	2.8			V
Reverse Leakage Current	$I_{LEAK}$	$V_R=3.3V$ , I/O to GND		0.5	1.0	$\mu A$
Clamp Voltage <sup>1</sup>	$V_C$	$I_{PP}=1A$ , $t_p=8/20\mu s$ , Fwd		5.5		V
		$I_{PP}=5A$ , $t_p=8/20\mu s$ , Fwd		7.0		V
		$I_{PP}=10A$ , $t_p=8/20\mu s$ , Fwd		9.0		V
		$I_{PP}=20A$ , $t_p=8/20\mu s$ , Fwd		13.5		V
Dynamic Resistance	$R_{DYN}$	$(V_{C2} - V_{C1}) / (I_{PP2} - I_{PP1})$		0.4		$\Omega$
ESD Withstand Voltage <sup>1</sup>	$V_{ESD}$	IEC61000-4-2 (Contact)	$\pm 30$			kV
		IEC61000-4-2 (Air)	$\pm 30$			kV
Diode Capacitance <sup>1</sup>	$C_{I/O-GND}$	Reverse Bias=0V		4.4	5.0	pF
Diode Capacitance <sup>1</sup>	$C_{I/O-I/O}$	Reverse Bias=0V		2.2		pF

**Note:**

1. Parameter is guaranteed by design and/or device characterization.

### Clamping Voltage vs. $I_{PP}$

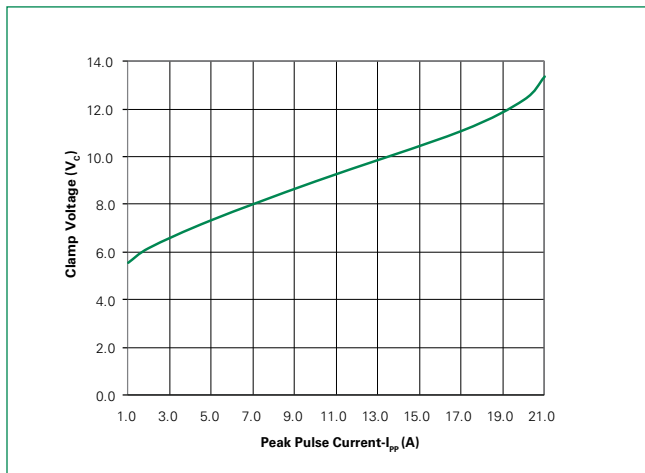

### Capacitance vs. Bias

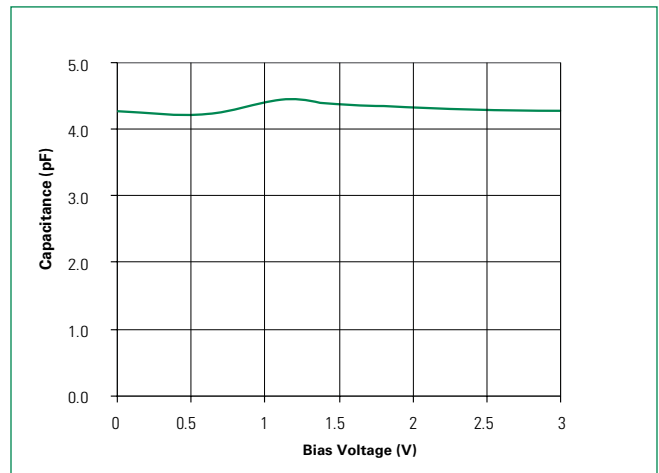

### 8/20µs Pulse Waveform

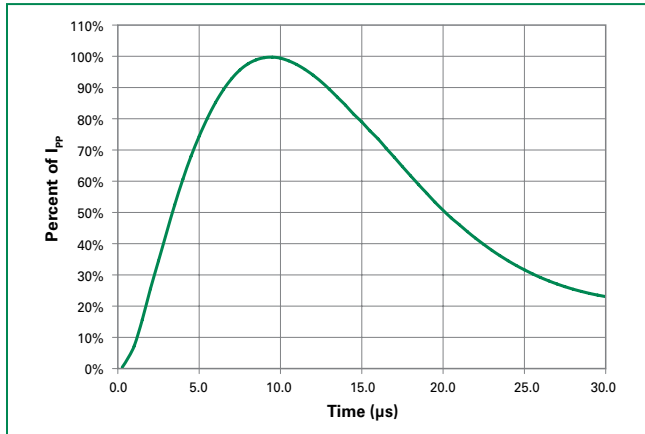

### Product Characteristics

<b>Lead Plating</b>	Pre-Plated Frame
<b>Lead Material</b>	Copper Alloy
<b>Lead Coplanarity</b>	0.0004 inches (0.102mm)
<b>Substrate material</b>	Silicon
<b>Body Material</b>	Molded Epoxy, rated UL 94 V-0

**Notes :**

1. All dimensions are in millimeters
2. Dimensions include solder plating.
3. Dimensions are exclusive of mold flash & metal burr.
4. Blo is facing up for mold and facing down for trim/form, i.e. reverse trim/form.
5. Package surface matte finish VDI 11-13.

### Soldering Parameters

<b>Reflow Condition</b>	Pb – Free assembly	
<b>Pre Heat</b>	- Temperature Min ( $T_{s(min)}$ )	150°C
	- Temperature Max ( $T_{s(max)}$ )	200°C
	- Time (min to max) ( $t_s$ )	60 – 180 secs
<b>Average ramp up rate (Liquidus) Temp (<math>T_L</math>) to peak</b>	3°C/second max	
<b><math>T_{s(max)}</math> to <math>T_L</math> - Ramp-up Rate</b>	3°C/second max	
<b>Reflow</b>	- Temperature ( $T_L$ ) (Liquidus)	217°C
	- Temperature ( $t_i$ )	60 – 150 seconds
<b>Peak Temperature (<math>T_p</math>)</b>	260 <sup>+0/-5</sup> °C	
<b>Time within 5°C of actual peak Temperature (<math>t_p</math>)</b>	20 – 40 seconds	
<b>Ramp-down Rate</b>	6°C/second max	
<b>Time 25°C to peak Temperature (<math>T_p</math>)</b>	8 minutes Max.	
<b>Do not exceed</b>	260°C	

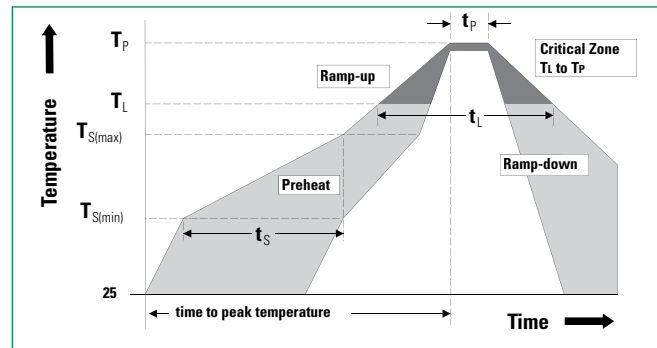

### Part Numbering System

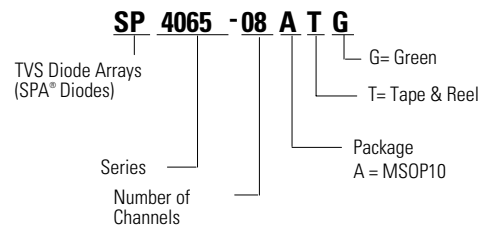

### Ordering Information

Part Number	Package	Min. Order Qty.
SP4065-08ATG	MSOP-10	4000

### Part Marking System

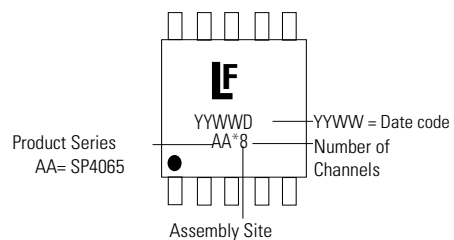

**Package Dimensions – MSOP-10**

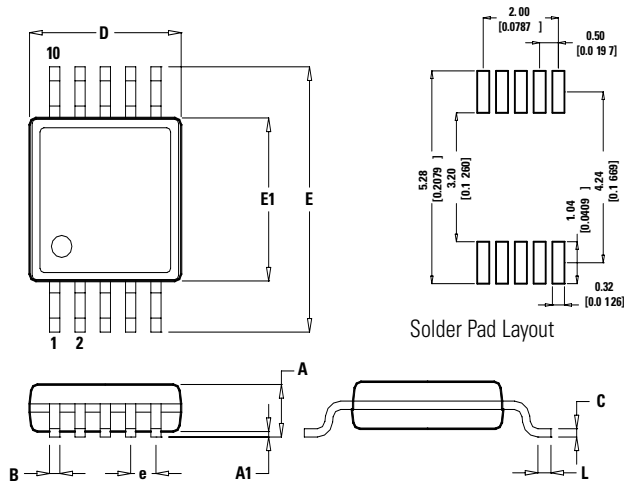

Package	MSOP			
Pins	10			
JEDEC	MO-187			
Symbol	Millimeters		Inches	
DIM	Min	Max	Min	Max
A	-	1.10	-	0.043
A1	0.00	0.15	0.000	0.006
B	0.17	0.27	0.007	0.011
c	0.08	0.23	0.003	0.009
D	2.90	3.10	0.114	0.122
E	4.67	5.10	0.184	0.200
E1	2.90	3.10	0.114	0.122
e	0.50 BSC		0.020 BSC	
L	0.40	0.80	0.016	0.032

**Embossed Carrier Tape & Reel Specification – MSOP-10**

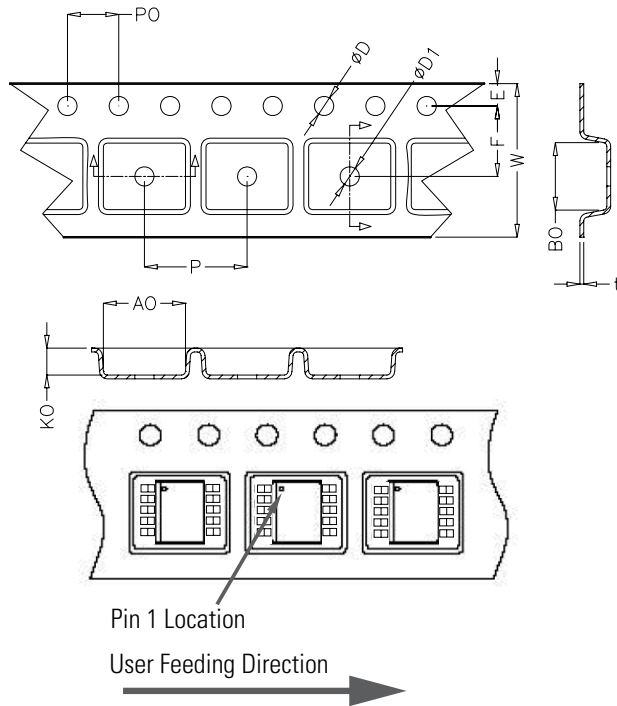

Symbol	Millimetres		Inches	
	Min	Max	Min	Max
E	1.65	1.85	0.065	0.073
e	0.5		0.02	
F	5.40	5.60	0.213	0.220
D	1.50	1.60	0.059	
D1	1.50 Min		0.059 Min	
P0	3.90	4.10	0.154	0.161
W	11.70	12.30	0.460	0.484
P	7.90	8.10	0.311	0.319
A0	5.20	5.40	0.205	0.213
B0	3.20	3.50	0.126	0.138
K0	1.20	1.50	0.047	0.059
t	0.30 +/- 0.05		0.012 +/- 0.002	