

## SMA6J Series



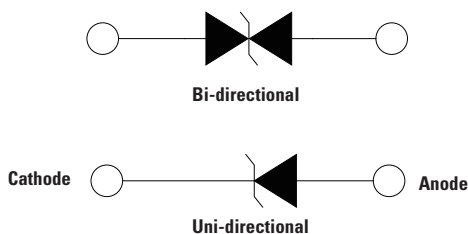
Agency Approvals	
Agency	Agency File Number
	E230531

### Maximum Ratings and Thermal Characteristics (T<sub>A</sub> = 25°C unless otherwise noted)

Parameter	Symbol	Value	Unit
Peak Pulse Power Dissipation by 10/1000µs Waveform (Fig.2) (Note 1), (Note 2)	P <sub>PPM</sub>	600	W
Power Dissipation on Infinite Heat Sink at T <sub>L</sub> = 50°C	P <sub>D</sub>	3.3	W
Peak Forward Surge Current, 8.3ms Single Half Sine Wave (Note 3)	I <sub>FSM</sub>	60	A
Maximum Instantaneous Forward Voltage at 25A for Unidirectional Only	V <sub>F</sub>	3.5	V
Operating Temperature Range	T <sub>J</sub>	-65 to 150	°C
Storage Temperature Range	T <sub>STG</sub>	-65 to 175	°C
Typical Thermal Resistance Junction to Lead	R <sub>θJL</sub>	30	°C/W
Typical Thermal Resistance Junction to Ambient	R <sub>θJA</sub>	120	°C/W

- Notes:**
1. Non-repetitive current pulse, per Fig.4 and derated above T<sub>J</sub> (initial) = 25°C per Fig. 3.
  2. Mounted on 5.0x5.0mm copper pad to each terminal.
  3. Measured on 8.3ms single half sine wave or equivalent square wave for unidirectional component only.

### Functional Diagram



### Description

The SMA6J series is designed specifically to protect sensitive electronic equipment from voltage transients induced by lightning and other transient voltage events.


### Features

- Small DO-214AC SMT footprint for minimal board space requirement
- Typical failure mode is a short circuit condition for current events exceeding component rating
- Whisker test is conducted based on JEDEC JESD201A per its table 4a and 4c
- IEC 61000-4-2 ESD 30kV(Air), 30kV (Contact)
- ESD protection of data lines in accordance with IEC 61000-4-2
- Built-in strain relief
- Glass passivated junction
- Low inductance
- Excellent clamping capability
- 600W peak pulsepower capability at 10/1000µs waveform, repetition rate (duty cycle): 0.01 %
- Fast response time: typically less than 1.0ps from 0 Volts to V<sub>BR</sub> min
- Typical I<sub>R</sub> < 1µA when V<sub>BR</sub> min > 12 V
- High temperature reflow soldering guaranteed: 260°C/30sec
- V<sub>BR</sub> @ T<sub>J</sub> = V<sub>BR</sub> @ 25°C × (1 + α T × (T<sub>J</sub> - 25)) (α T: Temperature Coefficient, typical value is 0.1%)
- UL Recognized compound meeting flammability rating V-0
- Meet MSL level1, per J-STD-020, lead-frame maximum peak of 260°C
- Matte tin lead-free plated
- Pb-free E3 means 2<sup>nd</sup> level interconnect is Pb-free and the terminal finish material is tin(Sn) (IPC/JEDEC J-STD-609A.01)

### Applications

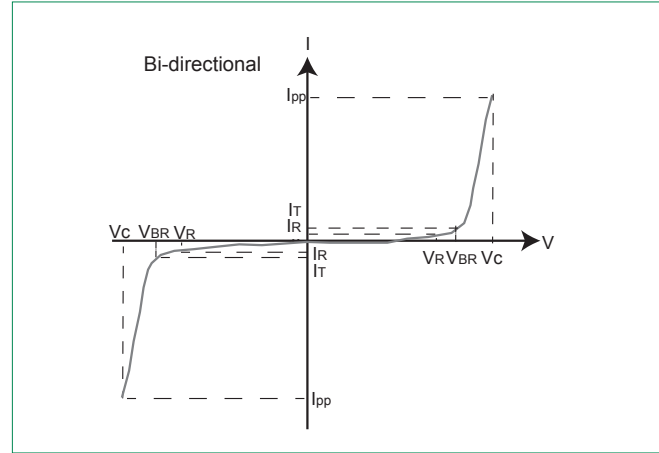
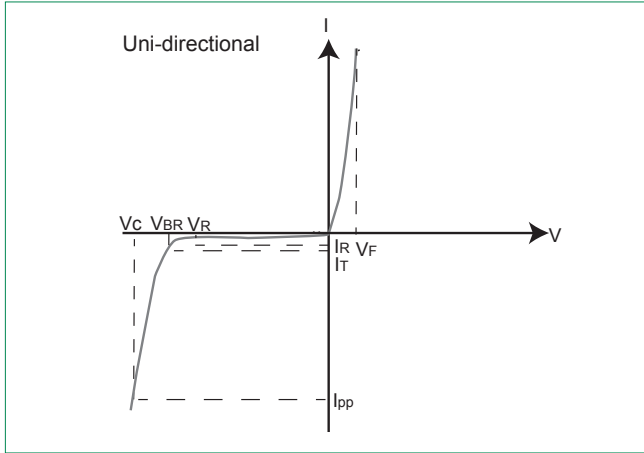
TVS components are ideal for the protection of I/O Interfaces, V<sub>CC</sub> bus and other vulnerable circuits used in Telecom, Computer, Industrial and Consumer electronic applications.

### Electrical Characteristics (T<sub>A</sub>=25°C unless otherwise noted)

Part Number (Uni)	Part Number (Bi)	Marking		Reverse Stand off Voltage V <sub>R</sub> (Volts)	Breakdown Voltage V <sub>BR</sub> (Volts) @ I <sub>T</sub>		Test Current I <sub>T</sub> (mA)	Maximum Clamping Voltage V <sub>C</sub> @ I <sub>PP</sub> (V)	Maximum Peak Pulse Current I <sub>PP</sub> (A)	Maximum Reverse Leakage I <sub>R</sub> @ V <sub>R</sub> (µA)	Agency Recognition 
		UNI	BI		MIN	MAX					
SMA6J5.0A	SMA6J5.0CA	6BA	6VVE	5	6.40	7.00	10	9.2	66.0	800	X
SMA6J6.0A	SMA6J6.0CA	6AG	6VVG	6	6.67	7.37	10	10.3	61.0	800	X
SMA6J6.5A	SMA6J6.5CA	6AK	6VWK	6.5	7.22	7.98	10	11.2	56.0	500	X
SMA6J7.0A	SMA6J7.0CA	6AM	6VWM	7	7.78	8.60	10	12.0	50.0	200	X
SMA6J7.5A	SMA6J7.5CA	6AP	6VWP	7.5	8.33	9.21	1	12.9	46.5	100	X
SMA6J8.0A	SMA6J8.0CA	6AR	6VWR	8	8.89	9.83	1	13.6	44.1	50	X
SMA6J8.5A	SMA6J8.5CA	6AT	6VWT	8.5	9.44	10.40	1	14.4	41.7	20	X
SMA6J9.0A	SMA6J9.0CA	6AV	6VWV	9	10.0	11.1	1	15.4	39.0	10	X
SMA6J10A	SMA6J10CA	6AX	6VWX	10	11.1	12.3	1	17.0	37.0	5	X
SMA6J11A	SMA6J11CA	6AZ	6VWZ	11	12.2	13.5	1	18.2	33.0	1	X
SMA6J12A	SMA6J12CA	6BE	6XE	12	13.3	14.7	1	19.9	31.0	1	X
SMA6J13A	SMA6J13CA	6BG	6XG	13	14.4	15.9	1	21.5	29.0	1	X
SMA6J14A	SMA6J14CA	6BK	6XK	14	15.6	17.2	1	23.2	25.8	1	X
SMA6J15A	SMA6J15CA	6BM	6XM	15	16.7	18.5	1	24.4	25.1	1	X
SMA6J16A	SMA6J16CA	6BP	6XP	16	17.8	19.7	1	26.0	23.1	1	X
SMA6J17A	SMA6J17CA	6BR	6XR	17	18.9	20.9	1	27.6	22.6	1	X
SMA6J18A	SMA6J18CA	6BT	6XT	18	20.0	22.1	1	29.2	21.5	1	X
SMA6J20A	SMA6J20CA	6BV	6XV	20	22.2	24.5	1	32.4	19.4	1	X
SMA6J22A	SMA6J22CA	6BX	6XX	22	24.4	26.9	1	35.5	17.0	1	X
SMA6J24A	SMA6J24CA	6BZ	6XZ	24	26.7	29.5	1	38.9	16.0	1	X
SMA6J26A	SMA6J26CA	6CE	6YE	26	28.9	31.9	1	42.1	14.9	1	X
SMA6J28A	SMA6J28CA	6CG	6YG	28	31.1	34.4	1	45.4	13.8	1	X
SMA6J30A	SMA6J30CA	6CK	6YK	30	33.3	36.8	1	48.4	12.5	1	X
SMA6J33A	SMA6J33CA	6CM	6YM	33	36.7	40.6	1	53.3	11.8	1	X
SMA6J36A	SMA6J36CA	6CP	6YP	36	40.0	44.2	1	58.1	10.4	1	X
SMA6J40A	SMA6J40CA	6CR	6YR	40	44.4	49.1	1	64.5	9.7	1	X
SMA6J43A	SMA6J43CA	6CT	6YT	43	47.8	52.8	1	69.4	8.7	1	X
SMA6J45A	SMA6J45CA	6CV	6YV	45	50.0	55.3	1	72.7	8.3	1	X
SMA6J48A	SMA6J48CA	6CX	6YX	48	53.3	58.9	1	77.4	8.1	1	X
SMA6J51A	SMA6J51CA	6CZ	6YZ	51	56.7	62.7	1	82.4	7.4	1	X
SMA6J54A	SMA6J54CA	6RE	6ZE	54	60.0	66.3	1	87.1	6.9	1	X
SMA6J58A	SMA6J58CA	6RG	6ZG	58	64.4	71.2	1	93.6	6.7	1	X
SMA6J60A	SMA6J60CA	6RK	6ZK	60	66.7	73.7	1	96.8	6.2	1	X
SMA6J64A	SMA6J64CA	6RM	6ZM	64	71.1	78.6	1	103	5.9	1	X
SMA6J70A	SMA6J70CA	6RP	6ZP	70	77.8	86.0	1	113	5.5	1	X
SMA6J75A	SMA6J75CA	6RR	6ZR	75	83.3	92.1	1	121	5.0	1	X
SMA6J78A	SMA6J78CA	6RT	6ZT	78	86.7	95.8	1	126	4.8	1	X
SMA6J85A	SMA6J85CA	6RV	6ZV	85	94.4	104	1	137	4.6	1	X
SMA6J90A	SMA6J90CA	6RX	6ZX	90	100	111	1	146	4.2	1	X
SMA6J100A	-	6RZ	-	100	111	123	1	162	3.8	1	X
SMA6J110A	-	6SE	-	110	122	135	1	177	3.5	1	X
SMA6J120A	-	6SG	-	120	133	147	1	193	3.2	1	X
SMA6J130A	-	6SK	-	130	144	159	1	209	2.9	1	X

For bidirectional type having V<sub>R</sub> of 10 volts and less, the I<sub>R</sub> limit is double.

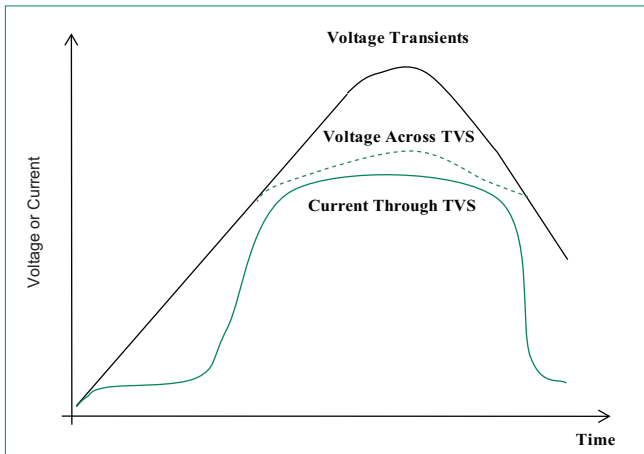
**I-V Curve Characteristics**



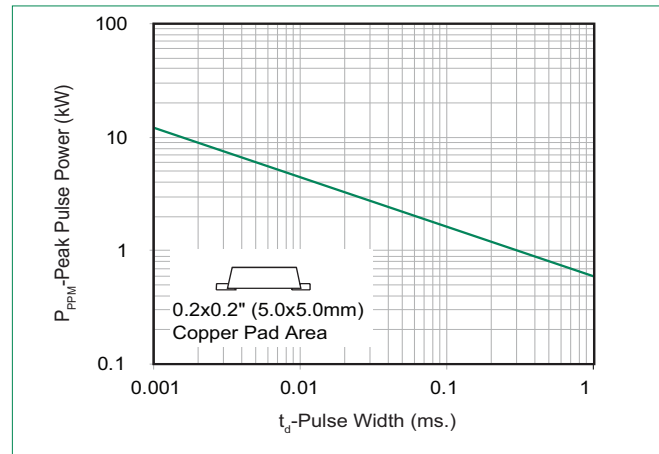
- $P_{PPM}$  Peak Pulse Power Dissipation** – Max power dissipation
- $V_r$  Stand-off Voltage** – Maximum voltage that can be applied to the TVS without operation
- $V_{BR}$  Breakdown Voltage** – Maximum voltage that flows through the TVS at a specified test current ( $I_r$ )
- $V_c$  Clamping Voltage** – Peak voltage measured across the TVS at a specified  $I_{PPM}$  (peak impulse current @ 10/1000)
- $I_r$  Reverse Leakage Current** – Current measured at  $V_r$
- $V_f$  Forward Voltage Drop for Uni-directional**

**Ratings and Characteristic Curves** ( $T_A=25^\circ\text{C}$  unless otherwise noted)

**Figure 1 - TVS Transients Clamping Waveform**

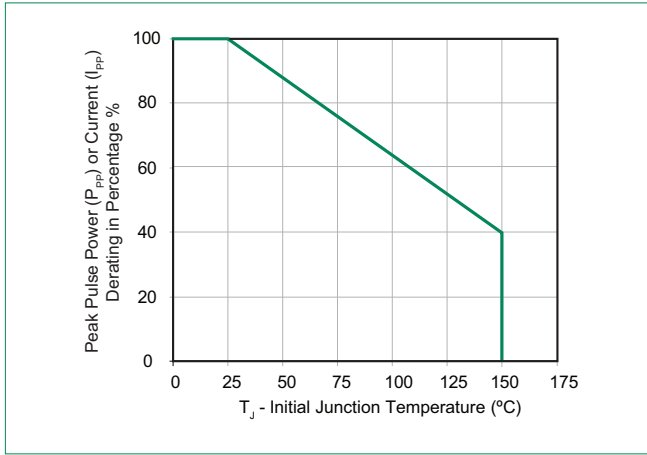


**Figure 2 - Peak Pulse Power Rating Curve**

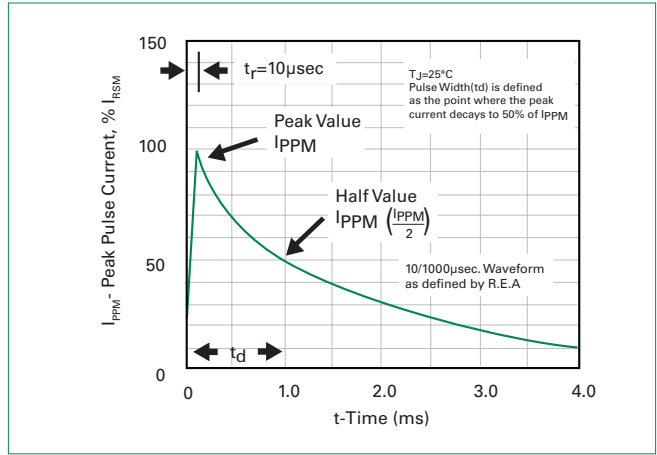


**Ratings and Characteristic Curves** ( $T_A=25^\circ\text{C}$  unless otherwise noted) (Continued)

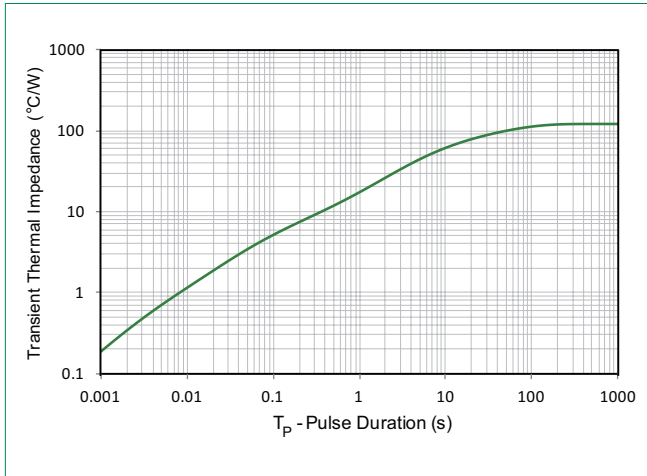
**Figure 3 - Peak Pulse Power Derating Curve**



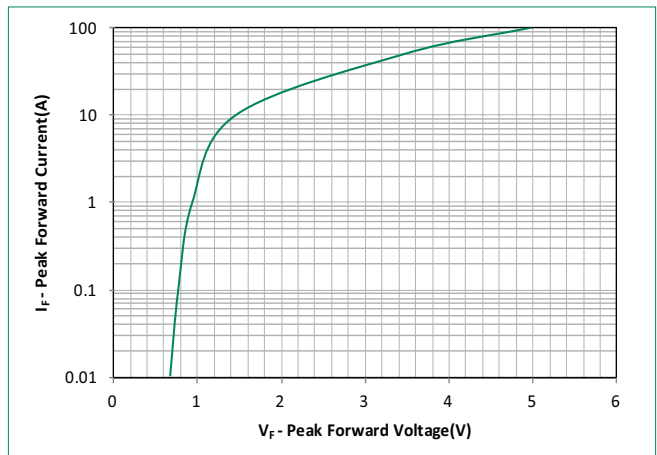
**Figure 4 - Pulse Waveform**



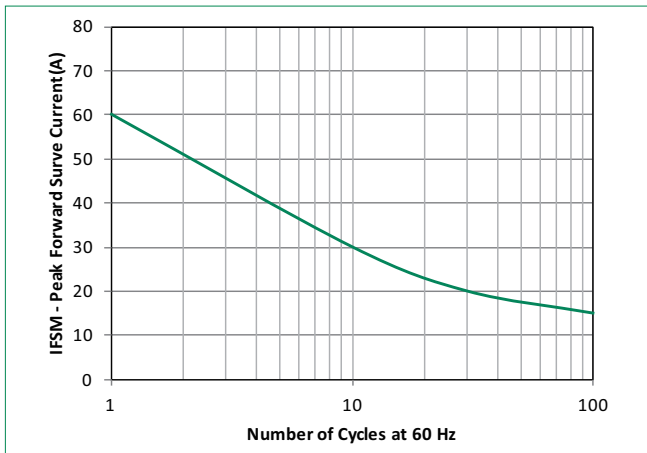
**Figure 5 - Typical Transient Thermal Impedance**



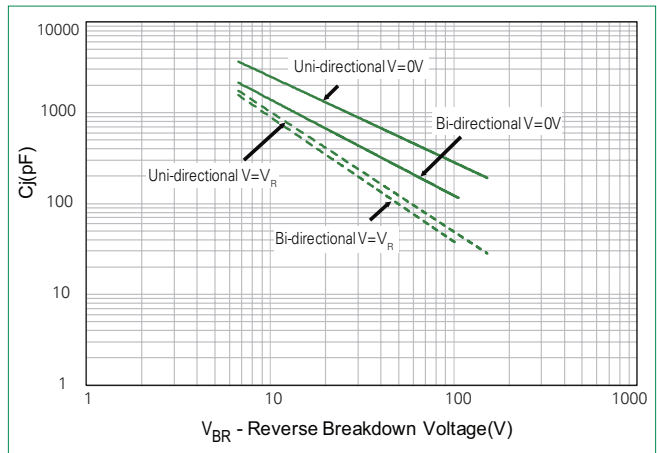
**Figure 6 - Peak Forward Voltage Drop vs Peak Forward Current (typical values)**



**Figure 7 - Maximum Non-Repetitive Forward Surge Current Uni-Directional Only**

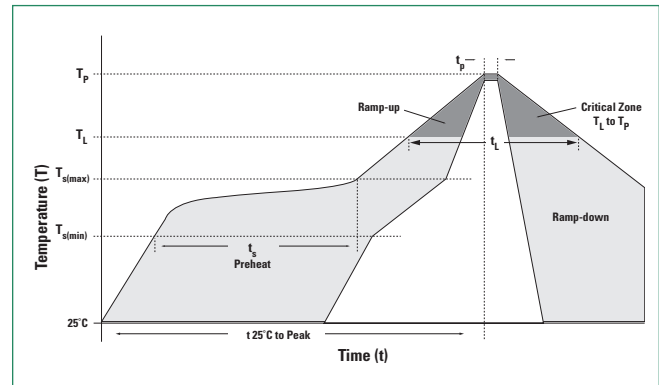


**Figure 8 - Typical Junction Capacitance**



### Soldering Parameters

<b>Reflow Condition</b>		Lead-free assembly
<b>Pre Heat</b>	- Temperature Min ( $T_{s(min)}$ )	150°C
	- Temperature Max ( $T_{s(max)}$ )	200°C
	- Time (min to max) ( $t_s$ )	60 – 120 secs
<b>Average ramp up rate (Liquidus Temp (<math>T_L</math>) to peak)</b>		3°C/second max
<b><math>T_{s(max)}</math> to <math>T_L</math> - Ramp-up Rate</b>		3°C/second max
<b>Reflow</b>	- Temperature ( $T_L$ ) (Liquidus)	217°C
	- Time (min to max) ( $t_L$ )	60 – 150 seconds
<b>Peak Temperature (<math>T_p</math>)</b>		260 <sup>+0/-5</sup> °C
<b>Time within 5°C of actual peak Temperature (<math>t_p</math>)</b>		30 seconds max
<b>Ramp-down Rate</b>		6°C/second max
<b>Time 25°C to peak Temperature (<math>T_p</math>)</b>		8 minutes Max.
<b>Do not exceed</b>		260°C



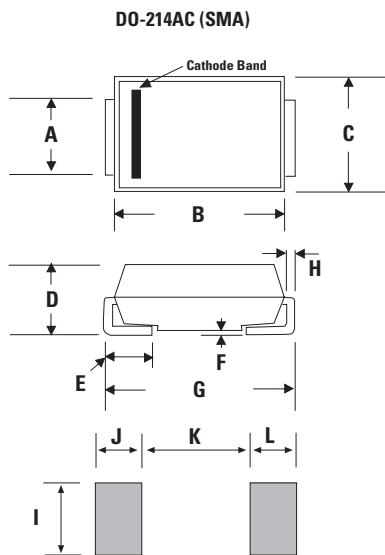
### Physical Specifications

<b>Weight</b>	0.002 ounce, 0.061 gram
<b>Case</b>	JEDEC DO-214AC Molded Plastic over glass passivated junction
<b>Polarity</b>	Color band denotes cathode except Bipolar
<b>Terminal</b>	Matte Tin-plated leads, Solderable per JESD22-B102

### Environmental Specifications

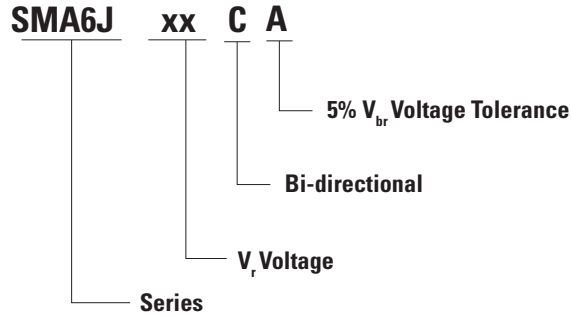
<b>High Temp. Storage</b>	JESD22-A103
<b>HTRB</b>	JESD22-A108
<b>Temperature Cycling</b>	JESD22-A104
<b>MSL</b>	JEDEC-J-STD-020, Level 1
<b>H3TRB</b>	JESD22-A101
<b>RSH</b>	JESD22-A111

### Dimensions

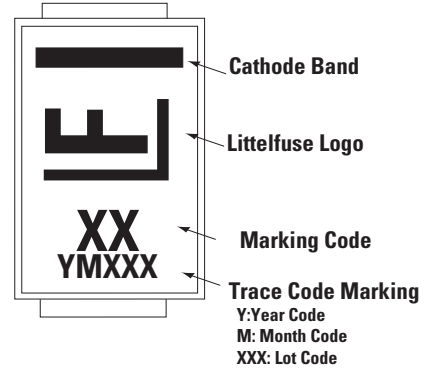


Dimensions	Inches		Millimeters	
	Min	Max	Min	Max
A	0.049	0.065	1.250	1.650
B	0.157	0.181	3.990	4.600
C	0.095	0.110	2.400	2.790
D	0.075	0.090	1.900	2.290
E	0.030	0.060	0.780	1.520
F	-	0.008	-	0.203
G	0.189	0.208	4.800	5.280
H	0.006	0.012	0.152	0.305
I	0.070	-	1.800	-
J	0.082	-	2.100	-
K	-	0.090	-	2.300
L	0.082	-	2.100	-

**Part Numbering System**



**Part Marking System**



**Packaging**

Part number	Component Package	Quantity	Packaging Option	Packaging Specification
SMA6JxxXX	DO-214AC	5000	Tape & Reel - 12mm tape/13" reel	EIA RS-481

**Tape and Reel Specification**

